

Renishaw's non-contact laser tool setting technology

Abstract

Laser systems for tool setting and broken tool detection on CNC machining centres have become more popular as manufacturers realise the benefits of fast process set-ups and inprocess feedback on tool condition, especially on small tools that cannot be measured using contact sensors.

First generation systems suffered limitations in terms of their robustness in day-to-day use, requiring frequent operator attention, while concerns about the flexibility of operation and ease of installation have prevented the application of such laser tool setters on certain classes of machine. Recent innovations from Renishaw have addressed these weaknesses, delivering a new generation of highly reliable, accurate and flexible tool measurement systems.

Laser tool setting basics

Non-contact tool setting systems use a beam of laser light passing between a transmitter and a receiver, located either on, or to each side of the machine bed, such that the beam passes through the working volume. The passage of a tool through the beam causes a reduction in light seen at the receiver, from which a trigger signal is generated. This latches the machine position at that instant, from which the tool's dimension can be derived. Such systems can also be used to detect broken tools, a process which involves rapidly moving the tool into a position where it should intersect the laser beam: if light reaches the receiver, the tool tip must be missing.

The benefits of non-contact laser tool sensing are:

- Faster tool setting cycles - tools can be moved into the laser beam at high speed without risk of damage
- Tools are measured at normal spindle speeds, accounting for run-out and taper 'pull-up'
- Very small, delicate tools can be measured without wear or damage
- Tool breakage can be checked at very high feed rates, increasing confidence in unmanned machining whilst minimising cycle time
- Each facet of a multi-tip tool can be checked for damage
- On-machine tool setting provides a fully automated means to update tool offsets, eliminating operator error, plus a means to monitor and compensate for thermal movement of the machine spindle

Factors that affect performance, flexibility and reliability

Accepting that laser tool setting systems provide attractive benefits, what are the design factors that impact on their effectiveness?

1. Optical scheme - optics and apertures shape and focus the laser beam, affecting measurement performance at different points along the beam
2. Environmental protection during machining - the machine's environment is harsh and the laser system optics must be kept clean and unobstructed to retain performance
3. Environmental protection during measurement - coolant and particles are still present during measurement, so protection must be maintained without loss of accuracy
4. Integration - how simple are the electrical control and air connections between the tool setter and the CNC, and what effect will this have on maintenance and cycle time?
5. Drip rejection - coolant drips and particles that pass through the laser beam during a measurement cycle must not be confused with the tool itself
6. Measurement methods - what are the limiting factors in tool setting accuracy and how can they be overcome?
7. Detection methods - what techniques are used to detect broken tools and how fast are they?
8. Software - easy-to-use cycles are needed to measure and detect a wide range of different tool types
9. Size and mounting arrangements - the smaller the better, with easy ways to mount the unit on typical machines

Optical scheme

First generation laser tool setters feature a focused beam design, with coherent but divergent light from the laser source passing through a lens that focuses it at a point between the transmitter and receiver units. The beam passes through a relatively large aperture.

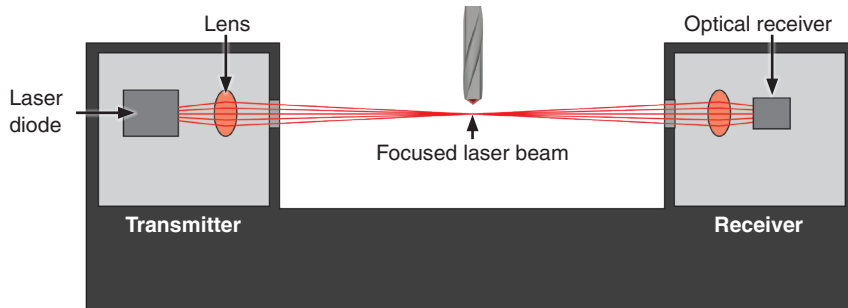

Figure 1 - Transmitter unit of a first generation laser tool setter providing a beam that is focused at a particular point between transmitter and receiver

In reality, constraints on the aperture size and the typical separation of the transmitter and receiver (which may be several metres) result in a laser beam that is not perfectly focussed to a single point. In fact, the beam narrows near the focal point to a size where it can be used to detect and measure small tools, although this capability diminishes as separation between transmitter and receiver increases.

In Renishaw's view, the main disadvantage of this type of system is a lack of flexibility - it is designed to measure tools only at the focal point, since the beam size and shape are not known reliably elsewhere. This means that the tool must be moved to this point before measurements can commence, which can add to cycle time on larger machines. Also, small tools cannot be sensed at other points in the beam since they do not block a sufficient amount of the beam to register a trigger.

Additionally, the laser needs to be very precisely centred on the aperture of the receiver for the optical detector to gather the light it needs; any significant misalignment of the beam could cause the system to become inoperable which may result in a long initial set-up period and slow in-service re-alignments.

In contrast, Renishaw's laser tool setters feature a much smaller, effectively parallel beam, produced by the laser light passing through a lens and two small apertures (see Figure 2). The MicroHole™ on the transmitter defines the shape and size of the emergent beam, which is slightly divergent along its length. A second MicroHole™ and, in some models, a pinhole inside the receiver, governs the light that reaches the optical detector. It is this narrow beam of light - a small subset of the overall emitted laser beam - that is the effective measuring beam.

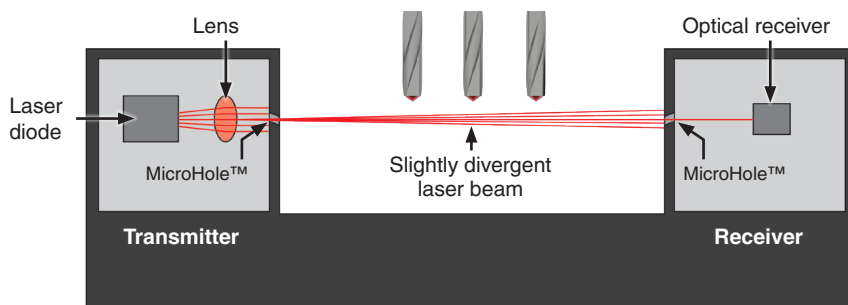

Figure 2 - Renishaw's transmitter unit features a lens that provides a narrow laser beam that passes through a small MicroHole™. The receiver further filters this light using a second MicroHole™, forming a very narrow, parallel measurement laser beam

For all systems, accurate tool measurement can only be achieved by first calibrating and then measuring each tool under the same conditions (axis feedrate, spindle speed, and position along the beam). Whilst conventional systems are repeatable only at their focal point, Renishaw's systems provide repeatable measurement at any point along the laser beam. By optimising the point of measurement to suit the machining process, users can save valuable cycle time on systems with large separations between the transmitter and receiver.

Set-up and re-alignment in-service are also easier, since the laser spot that reaches the receiver need not be perfectly aligned with the MicroHole™ in order to deliver sufficient light to the photo-sensor.

Environmental protection

The interior of a machining centre is a hostile environment, with coolant drips, swarf, chips or dust in the atmosphere and coating the surfaces of everything within the machine. Coolant mist saturates the air, quickly coating any exposed optical surfaces. Whatever their optical design, laser tool setting systems need clean optics and an unobstructed beam path in order to function repeatably. Environmental protection is therefore a key design consideration.

First generation technology

Conventional systems have relied on mechanical shutters to keep the optics clean, combined with an air blast to clear the aperture when the system is ready to measure (see Figures 3a, 3b and 3c). Typically the mechanical shutter assembly is housed in a separate module and is pneumatically operated via a solenoid valve, actuated by an M-Code or machine I/O signal issued from the controller. During machining, the shutter is held closed by a mechanical spring, and a continuous air 'bleed' flows from within the unit past small gaps around the shutter. As the shutter opens, the pressurised air behind the shutter is released in a 'blast' that passes through the aperture, clearing it of debris and liquid (Figure 3b).

Despite the protection afforded by the air bleed and the 'blast' when the shutter opens, in Renishaw's experience, in many machines such mechanisms require regular cleaning due to coolant ingress or seal failure, which eventually may cause the shutter mechanism to jam so that the system becomes inoperable. This increases the level of operator attention required and reduces productivity. Furthermore, the extra air and electrical connections required result in a complex installation.

In Renishaw's opinion, the most critical weakness of such designs is the lack of protection whilst the system is measuring. To obtain accurate readings, it is important that the laser beam path is free from air turbulence. Moving air introduces temperature gradients that affect the refractive index of the air, and in turn affect the direction of the laser beam. Even if air turbulence is not an issue, the large aperture means that a substantial air flow is needed to protect the optics, significantly increasing operating costs.

Once a conventional laser tool setter is ready to measure, the air 'bleed' is switched off, controlled by a separate M-Code on the CNC (see Figure 3c). With no protective air flow, no positive pressure inside the unit and a relatively large aperture, both transmitter and receiver units are effectively open to the elements, making them vulnerable to coolant or chips flying off the rotating tool, and from coolant mist condensing on the lens.

Early non-contact tool setter protection systems

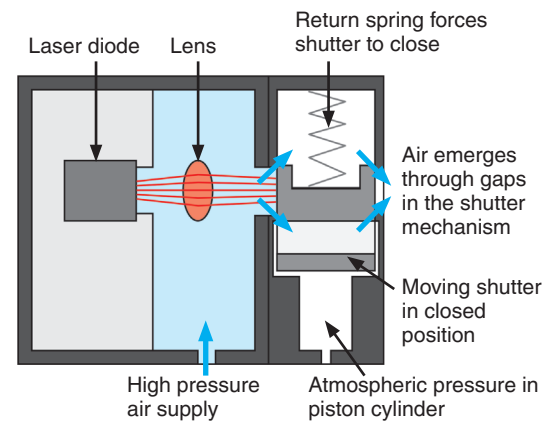

Figure 3a - During machining, conventional laser tool setters are protected by a moving shutter and continuous air 'bleed'

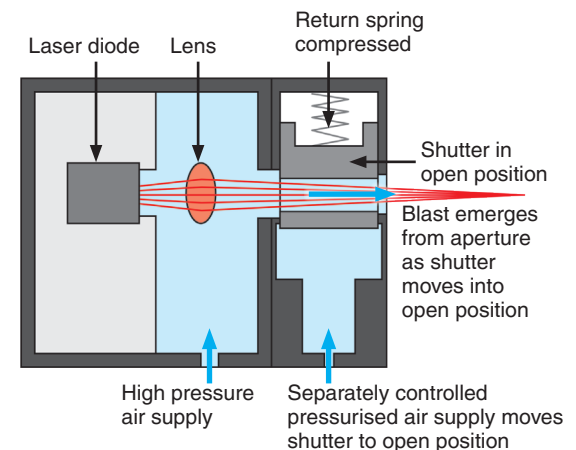

Figure 3b - Shutter is moved to open position by pressurised air, resulting in an air blast through the aperture as the trapped air in the optics chamber escapes

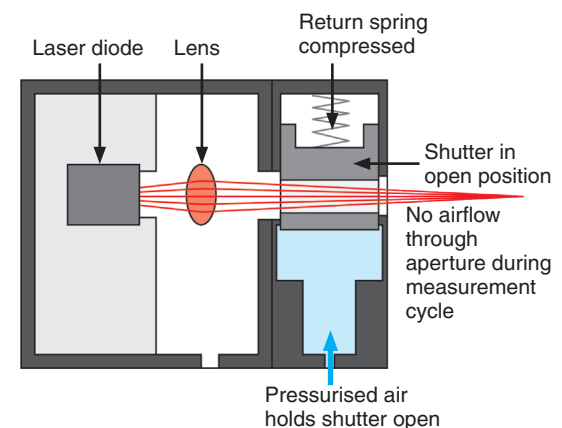

Figure 3c - Shutter is held open by pressurised air, whilst air bleed/blast is shut off to eliminate air turbulence along the laser beam

When checking broken tools, measurement accuracy is not so critical. It is therefore possible to leave the air flow on to provide greater protection. However, the large aperture requires a substantial air flow to provide protection from large, high energy particles in the atmosphere. This is especially relevant on systems with short transmitter / receiver separations, where the units are close to the spinning tool and to any coolant flows.

New MicroHole™ system offers 100% protection

Renishaw's patented MicroHole™ technology takes a radically different approach. Operating on the principal that moving parts should be avoided since they are liable to contamination or sliding seal failure and will eventually jam, no mechanical shutters are used. This has the consequential benefit of avoiding the need for additional shutter modules, solenoid control valves or M-Codes to actuate the system. Protection is provided by a continuous air stream that passes through a much smaller aperture than in conventional systems (refer to Figure 4).

The small diameter of the MicroHole™ ensures that the air emerges at speeds of up to 250 m/s. This flow rate is sufficient to protect the system during machining, even in machines with high pressure coolant systems. Despite the high velocity of the exiting air, the consumption of air is low: comparable to the air bleed on conventional systems.

The critical point to note here is that the air flow remains active during measurement, maintaining the same level of protection at all times. Coolant spraying off the tool, or dripping from the machine's interior, cannot enter the tool setter units. Positive pressure is maintained within the unit, such that coolant mist has no opportunity to condense on the lens and thus to disrupt the laser beam. To avoid problems of air turbulence affecting the measurement accuracy, the air flow is angled so that it is not aligned with the laser beam. The additional shutter modules in conventional systems require a larger system footprint for a comparable beam length than a system equipped with the MicroHole™ protection system. This is a critical factor on small fixed systems, or where there is very limited space for mounting brackets on separate systems. The additional distance between the exterior aperture and the optical detector, needed to accommodate the shutter mechanism, makes conventional systems more sensitive to angular mis-alignments on separate systems.

The MicroHole™ design provides many advantages:

- No moving parts and no regular maintenance/cleaning required
- 100% protection during machining and during the measurement itself
- Broken tool detection can be carried out with coolant present
- Single air supply and no additional M-Codes make for simple installation
- Small system footprint allows the system to be installed on machines with limited space
- Easy alignment for short install times

Drip rejection

The measurement process, although lasting only a few seconds, is long enough for the chance that a falling drip will intersect the beam to be more than a remote possibility. A laser tool setter must be able to distinguish between reductions in light at the receiver that are due to a falling object as compared to a spinning tool, if it is to avoid 'false triggers' and hence tool measurement errors.

Renishaw's non-contact tool setters recognise the different behaviours of drips and tools. Electronics in the tool setter interface unit can filter out signals caused by coolant drips and the like in order to establish exactly when the tool breached the trigger threshold. Note that this technique does not work if there is a continuous flow of coolant through the beam, and is not used during radial broken tool detection, cutter edge and profile checking.

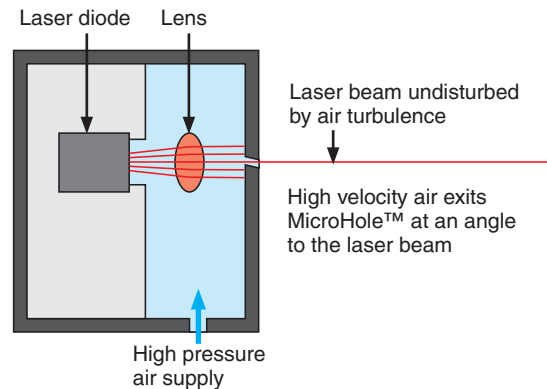

Figure 4 - Renishaw MicroHole™ technology provides continuous protection with no moving parts, even during measurement

Measurement methods

On any tool, one of the cutting edges will be further from the centre of rotation than the others, and it will be this cutting edge that defines the diameter of the tool. In Figure 5a, for example flute 2 is the defining edge, since it extends from the centre-line further than flute 1. When measuring diameter, the cutting tool is spun whilst the tool is moved at a constant feedrate into the laser beam. In order to obtain an accurate reading of the tool size, it is important that a repeatable measurement is obtained. Since flute 2 is more prominent than flute 1, it will be this edge that intersects the beam first. The edge moves in a circular path, onto which the axial feedrate perpendicular to the laser beam is superimposed (see Figure 5b). For each revolution of the tool, the prominent edge approaches the laser beam by an increment - the feed per revolution. This introduces a potential error into the tool size measurement.

For instance, a tool spinning at 1,000 rpm and moving towards the laser beam at 100 mm/min will advance by 100 µm between intersections of its prominent cutting edge with the laser beam. This is the maximum possible 'feed per revolution' error for any one reading. Of course, better accuracy can be gained by spinning faster or advancing more slowly. For instance, 1 µm per rev can be obtained by spinning the tool at 3,000 rpm and advancing at 3 mm/min.

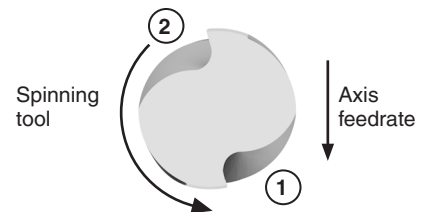

Figure 5a - One edge will extend further than the others from the centreline and will break the laser beam before the others

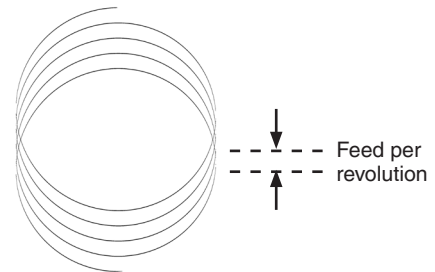

Figure 5b - Feed per revolution is a factor in diameter measurement uncertainty

To minimise cycle times, Renishaw tool measurement software programs the machine to move the tool into the beam firstly from a stand-off distance that is sufficient to account for the uncertainty of tool construction (this is particularly relevant when setting the length of a tool held in a collet or similar tool holder). The initial move is at a fast feedrate to gain an approximate position, from which the tool is backed off by a small distance. The tool is probed again at a reduced feedrate to find the tool location more accurately, from where a very short back-off move is executed. Finally, a measurement move is made at a very low feedrate in order to secure an accurate measurement. This process is faster than approaching at a low feedrate from a larger stand-off distance (see Figure 6).

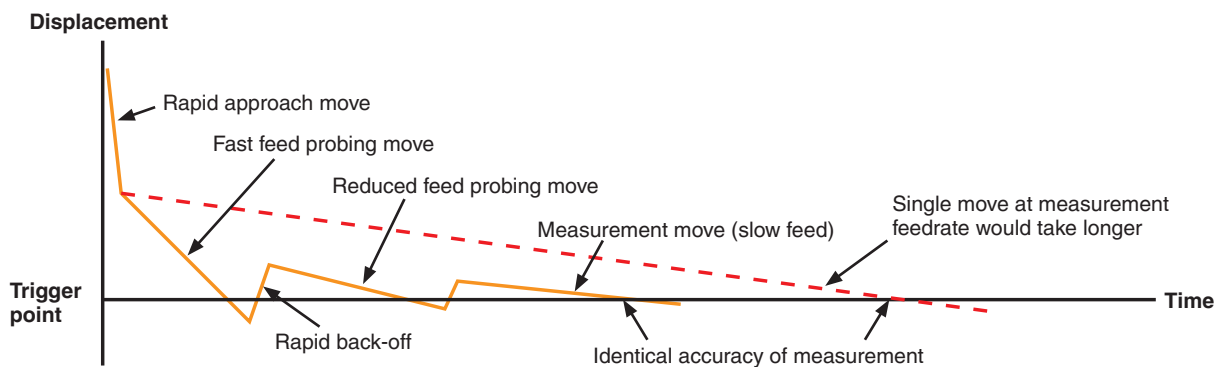

Figure 6 - Multi-stage tool measurement cycle involves probing at fast, reduced and then measurement feedrates from progressively shorter back-off distances

Another challenge to accurate tool measurement is the presence of coolant or debris on the tool tip that is being measured. This is the most significant disadvantage of non-contact sensing compared to contact measurement techniques, which measure contact with the hard surface of the tool and which can ignore liquid drips and films. This problem can be overcome by spinning the tool at very high speed to dislodge any residue, or by using an air blast.

Another technique built into Renishaw software is the capacity to measure several times and apply a 'scatter tolerance' to check for variation caused by measuring something other than the tool itself (see Figure 7). The routine will retake readings until it gets several values within the required tolerance (both the number of retries and the scatter tolerance can be set by the user).

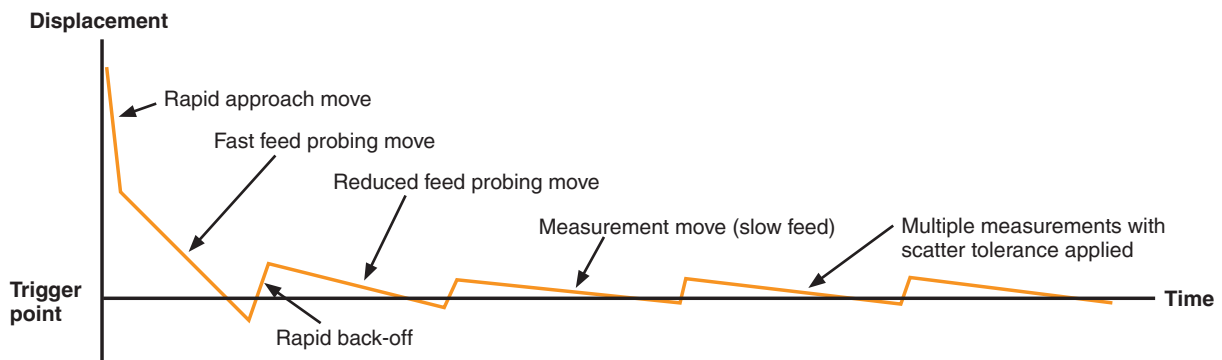

Figure 7 - Multiple measurement moves are designed to ensure that residue on the tool does not affect the measurement result

Detection methods

Broken tool detection is less demanding than tool measurement in terms of accuracy, but cycle time is critical. Any technologies or techniques that can shave seconds off machining cycle times are valuable to manufacturers. The demands on a laser broken tool detection system are therefore to be active at the moment it is needed, and to be able to operate in the prevailing conditions immediately after machining stops.

Renishaw's 'always on' design means that no time is wasted powering up and stabilising the laser diode, or waiting whilst a shutter is actuated, unlike first generation systems. The device is ready to check broken tools without delay. A more significant factor is the presence of coolant in the machine. During most machining operations the coolant will be active and generally takes a few seconds to turn fully off. Conventional laser systems may be vulnerable to large, high-energy particles or droplets entering their large apertures, whereas Renishaw's efficient MicroHole™ design ensures that the presence of such coolant does not affect the integrity of the laser system.

Whilst Renishaw laser systems can operate reliably in the presence of coolant, how can they detect broken tools under such conditions? The secret is an innovative broken tool detection technique, which works as follows:

- end of tool moved at rapid traverse speed into laser beam by 0.2 mm
- tool breakage cycle activated via M-Code
- end of tool dwells in the beam for between 0.1 secs and 0.3 secs
- if light is received at the receiver for more than a specified period (dependent on model, normally around 10 μ s) - tool broken
- if light is not received at the receiver - tool OK
- rapid home

This technique enables small tools to be checked even with the coolant system still fully on, minimising cycle times.



Figure 8 - Checking broken tools with the coolant system still active

Software

Some of the features of Renishaw's measurement and broken tool detection routines have been discussed in previous sections. Powerful software routines are needed to take full advantage of the flexibility afforded by non-contact tool sensing. Renishaw's approach has been to develop a wide range of measurement routines compatible with popular brands of CNC, enabling manufacturers to measure the full range of cutting tool types.

Measurement routines include:

- Length setting
- Diameter/radius setting
- Temperature compensation/monitoring (using a datum tool)
- Measuring profiles (see Figure 9)
- Maximum diameter search routines

Broken tool detection routines include:

- Radial length check
- Axial length check
- Radial diameter check
- Edge checking/insert missing detection (see Figure 10)

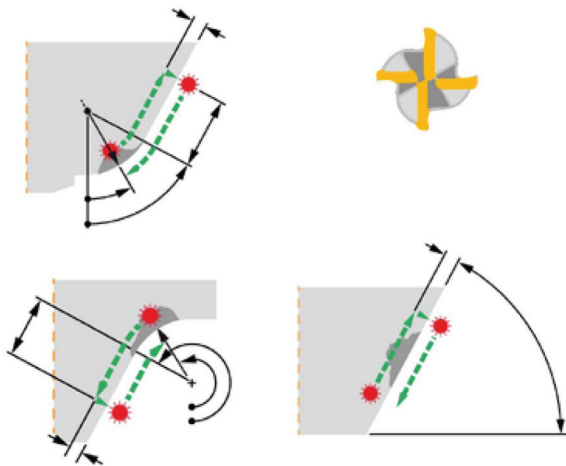

Figure 9 - Profile checking routines

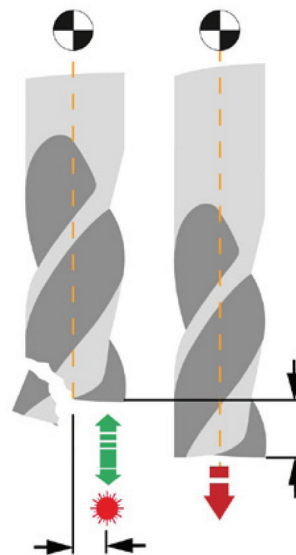

Figure 10 - Edge checking/insert missing detection routine

Size and mounting arrangements

Laser tool setters come in two main forms:

1. Fixed systems with a unitary construction that are typically mounted to the bed of a vertical machining centre or small high-speed machine
2. Separate systems with transmitter and receivers mounted on brackets on either side of the working volume of the machine, which are often used on horizontal machining centres with pallet changers

Fixed systems have the advantages of rapid installation and lower system costs, but the disadvantage of encroaching on the machine's operating volume. The important design objective here is therefore to minimise the footprint that the unit occupies, whilst maximising the size of tools that can be measured. Renishaw's NC4 tool setter features MicroHole™ protection and therefore has no requirement for additional shutter modules, resulting in a smaller footprint and a longer measuring range than competing conventional systems.

Separate systems do not encroach on the machining area, which is essential in machines with pallet changers. However, they are generally more costly and complex to install compared to fixed systems, and tend to provide slightly lower repeatability due to the increased separation between the transmitter and receiver units.

Once again, compact dimensions are critical, since the space available around the operating volume of many horizontal machining centres is very limited. A further factor with separate systems is the challenge of installation and subsequent readjustment in service.

Renishaw's MicroHole™ technology allows for generous alignment tolerances for faster set-up, whilst a 3-plate adjuster system (see Figure 11) provides controlled and rigid alignment of the units.

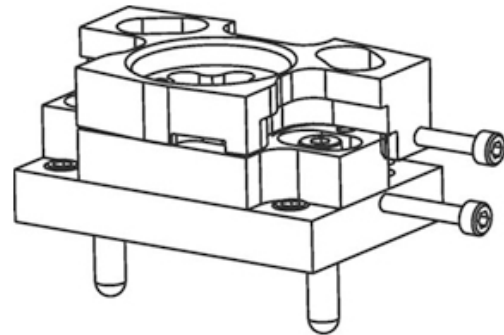

Figure 11 - 3-plate adjuster pack

Conclusions

Laser tool setting systems provide manufacturers with a rapid, accurate and flexible way to control tool dimensions and increase machining automation, with significant advantages over contact sensing and off-line pre-setting. However, the environmental conditions on the machine and the physics of laser sensing present significant engineering challenges that must be addressed if these devices are to deliver on their performance promises.

Renishaw takes full account of these factors through an innovative optical scheme and protection system, plus unique methods for tool measurement, broken tool detection and drip rejection. Combined with powerful software, flexible mounting arrangements and a custom design service, the result is a range of compact, fast, cost-effective and reliable solutions, suitable for even the most challenging tool measurement applications.