

# TB20 quadrature trigger box





## Contents

Legal information . . . . .	3	Diagnostics . . . . .	22
Safety information . . . . .	5	Power LED . . . . .	22
What is TB20? . . . . .	8	Status LED . . . . .	23
TB20 kit components . . . . .	9	System specifications . . . . .	24
TB20 interface . . . . .	10	Encoder types supported . . . . .	25
TB20 configurations . . . . .	11	Environment . . . . .	26
Test overview . . . . .	12	Maximum velocities . . . . .	26
TB20 set-up . . . . .	13	Weights and dimensions . . . . .	27
Trigger interval set-up . . . . .	14	Appendix A . . . . .	28
Switch set-up . . . . .	16	Wiring . . . . .	28
Data capture . . . . .	17	Appendix B . . . . .	29
Data capture reset button . . . . .	18	Accuracy . . . . .	29
Quasi-static data capture using CARTO Capture . . . . .	19	Delays in open loop . . . . .	29
Dynamic data capture using LaserXL dynamic measurement . . . . .	20	Accuracy - Delays in closed loop . . . . .	30
Data analysis . . . . .	21		



## Legal information

### Warranty

Equipment requiring attention under warranty must be returned to your equipment supplier.

Unless otherwise specifically agreed in writing between you and Renishaw, if you purchased the equipment from a Renishaw company, the warranty provisions contained in Renishaw's CONDITIONS OF SALE apply.

You should consult these conditions in order to find out the details of your warranty but, in summary, the main exclusions from the warranty are if the equipment has been:

- neglected, mishandled or inappropriately used; or
- modified or altered in any way except with the prior written agreement of Renishaw.

If you purchased the equipment from any other supplier, you should contact them to find out what repairs are covered by their warranty.



## Legal information

### International regulations and conformance

#### EC and UKCA compliance

Renishaw plc declares that the TB20 quadrature trigger box complies with the applicable standard and regulations.

Renishaw plc hereby declares that the TB20 quadrature trigger box is in compliance with the essential requirements and other relevant provisions of Directive 1999/5/EC.

Contact Renishaw plc or visit <http://www.renishaw.com/en/certification--38812> for the full EC declaration of conformity.



#### Disposal of waste electrical and electronic equipment

The use of this symbol on Renishaw products and/or accompanying documentation indicates that the product should not be mixed with general household waste upon disposal. It is the responsibility of the end user to dispose of this product at a designated collection point for waste electrical and electronic equipment (WEEE) to enable reuse or recycling. Correct disposal of this product will help to save valuable resources and prevent potential negative effects on the environment. For more information, please contact your local waste disposal service or Renishaw distributor.



#### RoHS compliance

Compliant with EC directive 2011/65/EU (RoHS).

#### Packing material information

Packaging component	Material	ISO 11469	Recycling guidance
Outer box	Cardboard	Not applicable	Recyclable
	Polypropylene	PP	Recyclable
Loose form packing	Maize starch	Not applicable	Recyclable
Bags	Low density polyethylene	LDPE	Recyclable
	Metalised polyethylene	PE	Not currently recyclable



## Safety information

---

**ENSURE THAT YOU READ AND UNDERSTAND THE TB20 USER GUIDE BEFORE USING ANY TB20.**

---

The TB20 can be used in a variety of environments and applications. To ensure the safety of the user and other personnel in the vicinity it is therefore paramount that a comprehensive risk assessment is carried out for the machine under test before using the TB20. This should be carried out by qualified users (requiring machine competency, applicable technical knowledge and a trained risk assessor) with consideration for the safety of all personnel. The risks identified must be mitigated prior to using the product. The risk assessment should pay particular attention to machine, manual handling, mechanical, laser, electrical and power.

### General safety information

The TB20 quadrature trigger box is designed for integration into the primary position feedback loop of a motion system. It is essential that the system is installed in accordance with the instructions in the installation manuals and it is the responsibility of the system integrator to ensure that, in the event of a failure of any part of the TB20, the motion system remains safe.

In motion systems with powers or speeds capable of causing injury, safety protection measures must be included in the design. It is recommended that satisfactory operation of these protection measures is verified before the feedback loop is closed. The following safety protection measures should be used. For closed loop operation it is the sole responsibility of the system integrator to select appropriate measures for their application.

1. The axis must include physical limit switches which, when tripped, will stop axis motion before damage occurs (soft limits alone are insufficient). Note that in the case of thermally compensated systems, positional corrections of several hundred ppm are possible. This should be taken into account when defining the relative positions of soft and hard axis limits.
2. Cable breakage detection (encoder disconnect). The position feedback is provided as differential line driven pairs. Failure in the cable or of the line drivers can be detected by checking these differential pairs are always being driven in opposing states. If the lines are not in opposing states, the motion must be stopped.
3. Motor torque monitoring. If the motor torque exceeds an expected limit, the axis of motion must be stopped.
4. The machine must include an emergency stop button.
5. Following error detection. If the difference between the controller demand position and the axis feedback position exceeds an expected limit, the axis motion must be stopped.
6. Guards, viewing windows, covers and interlocks may be used to prevent user access to hazardous areas, and to contain ejected parts or materials.
7. If the machine includes an independent tacho (velocity) feedback system, this should be cross-checked with the position feedback. For example, if the tacho indicates the axis is moving, but the position feedback doesn't, the axis motion must be stopped.

---

**NOTE:** In the case of measures 5 to 7, the limits need to be selected carefully depending on the application and the type of position compensation selected to avoid false alarms.

---



## Safety labelling



**THE DEVICE COMPLIES WITH PART 15 OF THE FCC RULES. OPERATION IS SUBJECT TO THE FOLLOWING CONDITIONS: (1)THIS DEVICE MAY NOT CAUSE HARMFUL INTERFERENCE. (2)THIS DEVICE MUST ACCEPT ANY INTERFERENCE RECEIVED. INCLUDING INTERFERENCE THAT MAY CAUSE UNDESIRED OPERATIONS.**



**WARNING:** There are no user-serviceable parts inside the TB20. Do not remove any part of the housing.

**CAUTION:** Ensure that you read and understand the TB20 user guide before using any TB20.



## Mechanical safety

- Beware of trip hazards that may be created when using the TB20 in conjunction with other systems, for example due to trailing cables.
- Exercise caution if components are to be mounted to moving or rotating machinery. Beware of cables becoming entangled.
- Exercise extreme caution if system components are to be mounted to machinery that may accelerate rapidly or move at high speed, which could lead to items colliding or being ejected.
- If it is necessary to operate the machine with the guards or any safety feature removed or disabled, it is the responsibility of the operator to ensure that alternative safety measures are taken in line with the machine manufacturer's operating instructions or relevant codes of practice.
- If you are using a part program or error correction parameters generated by the Renishaw software, it is the responsibility of the user to validate these at low feedrate and be prepared to operate the emergency stop button if necessary.



## Electrical and power safety

- The TB20 has been qualified for use with the power supply cable and the plug adaptor kit supplied with the system. A specification for the power supply requirements can be found **on page 24**.
- In the event of damage to the power adaptor, all power must be isolated from the equipment before any other action is taken.
- Never connect the system to devices not intended to be used with the TB20.



## What is TB20?

TB20 is an interface which is used with Renishaw's XL laser calibration system.

TB20 reads output from an encoder and generates a trigger for the laser system at predetermined intervals. Typical uses are leadscrew calibration and motion control set-up.

### The basic operation principle is:

- TB20 receives quadrature input pulses from an encoder system.
- For every 'Nth' input pulse it generates a TPin trigger (N is defined by the user).
- The XL laser records the laser reading when the TPin trigger is received.
- TB20 can regenerate the original quadrature pulses for the controller so the servo loop is not broken.

---

**NOTE:** For information on delay durations for signal regeneration at the controller port and for trigger generation refer to **Appendix B**.

---







## TB20 kit components

1	TB20 trigger box
2	XL trigger cable
3	Power supply cable
4	Plug adaptor kit
5	TB20 encoder and controller port connectors
6	Calibration user guide card



M-9904-4443-01-A

**RENISHAW**  
apply innovation™

**Laser calibration user guides**

EN Laser calibration user guides can be found at:  
 DE Benutzerhandbücher zur Laserkalibrierung finden Sie unter:  
 JA レーザー計測ユーザーガイドは、次のサイトをご覧ください:  
 ZH-TW 雷射校准使用指南位於:  
 ZH 雷射校准使用指南可从雷尼绍网站下载:  
 ES Las guías de usuario de calibración se pueden encontrar en:  
 KO 레이저 캘리브레이션 사용자 안내서가 제공되는 웹 페이지:  
[www.renishaw.com/caluserguides](http://www.renishaw.com/caluserguides)



## TB20 interface



1	USB port
2	Power LED
3	Trigger interval switches
4	Encoder port
5	Controller port
6	Trigger port
7	Status LED
8	Configuration switches
9	Reset switch



## TB20 configurations

### Open loop

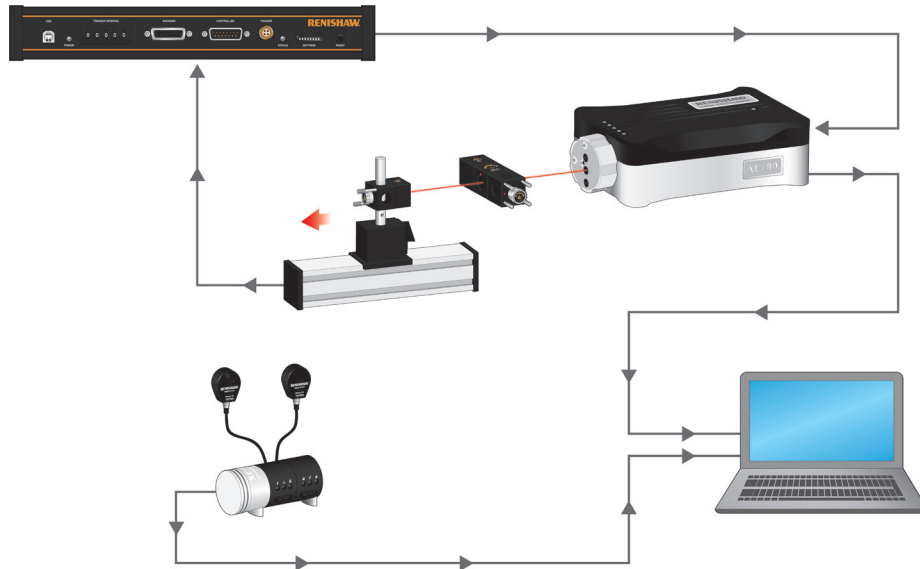

### Closed loop

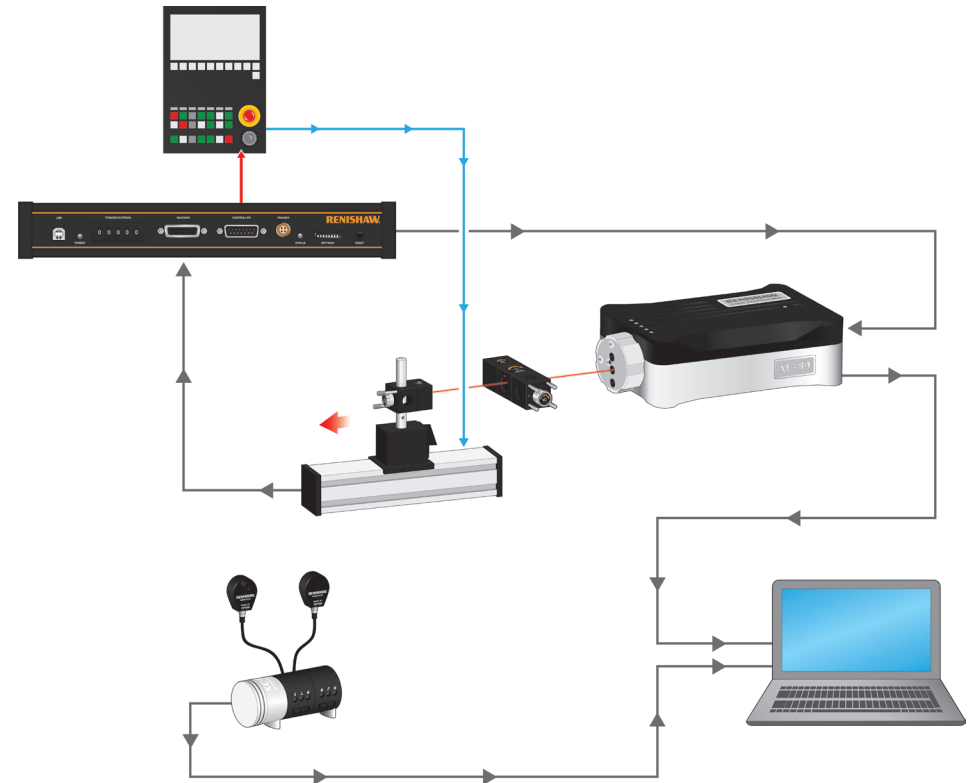



## Test overview

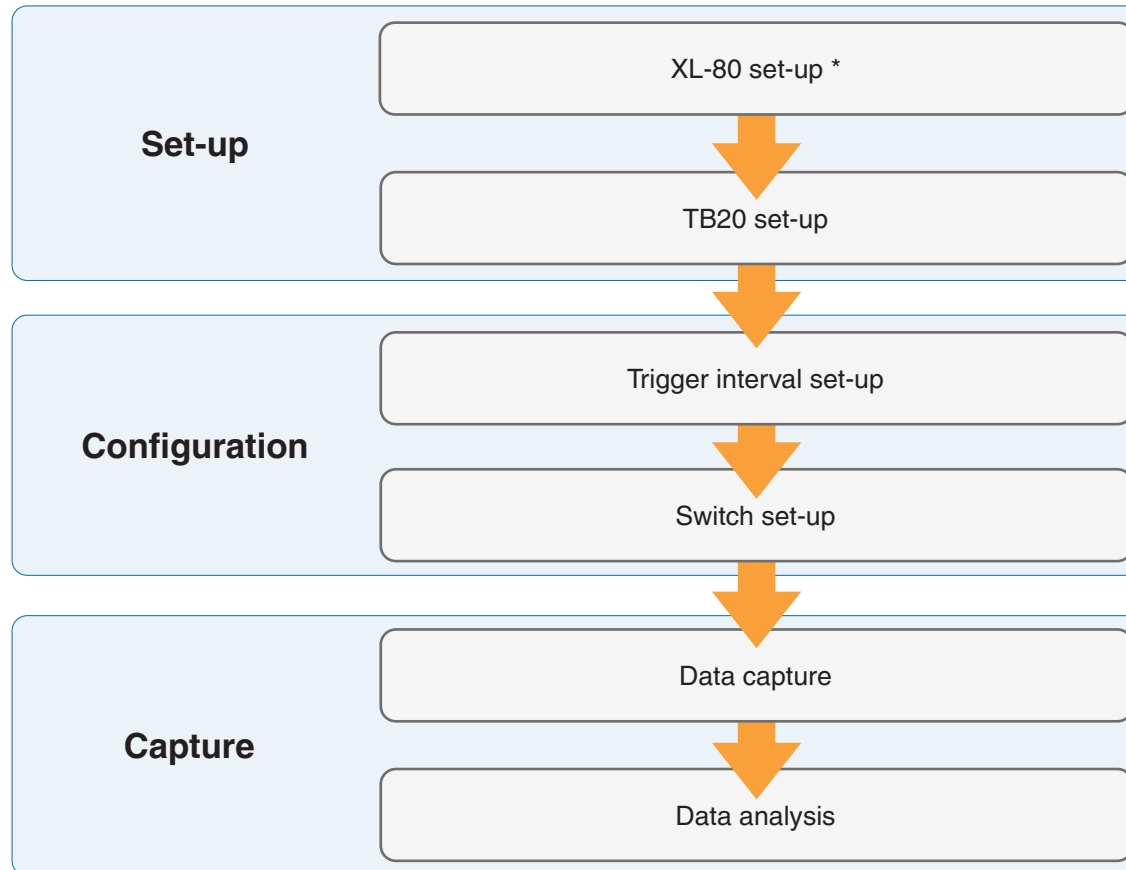

**NOTE:** \* For XL-80 set-up procedure, please refer to *XL-80* user guide F-9908-0683.



## TB20 set-up

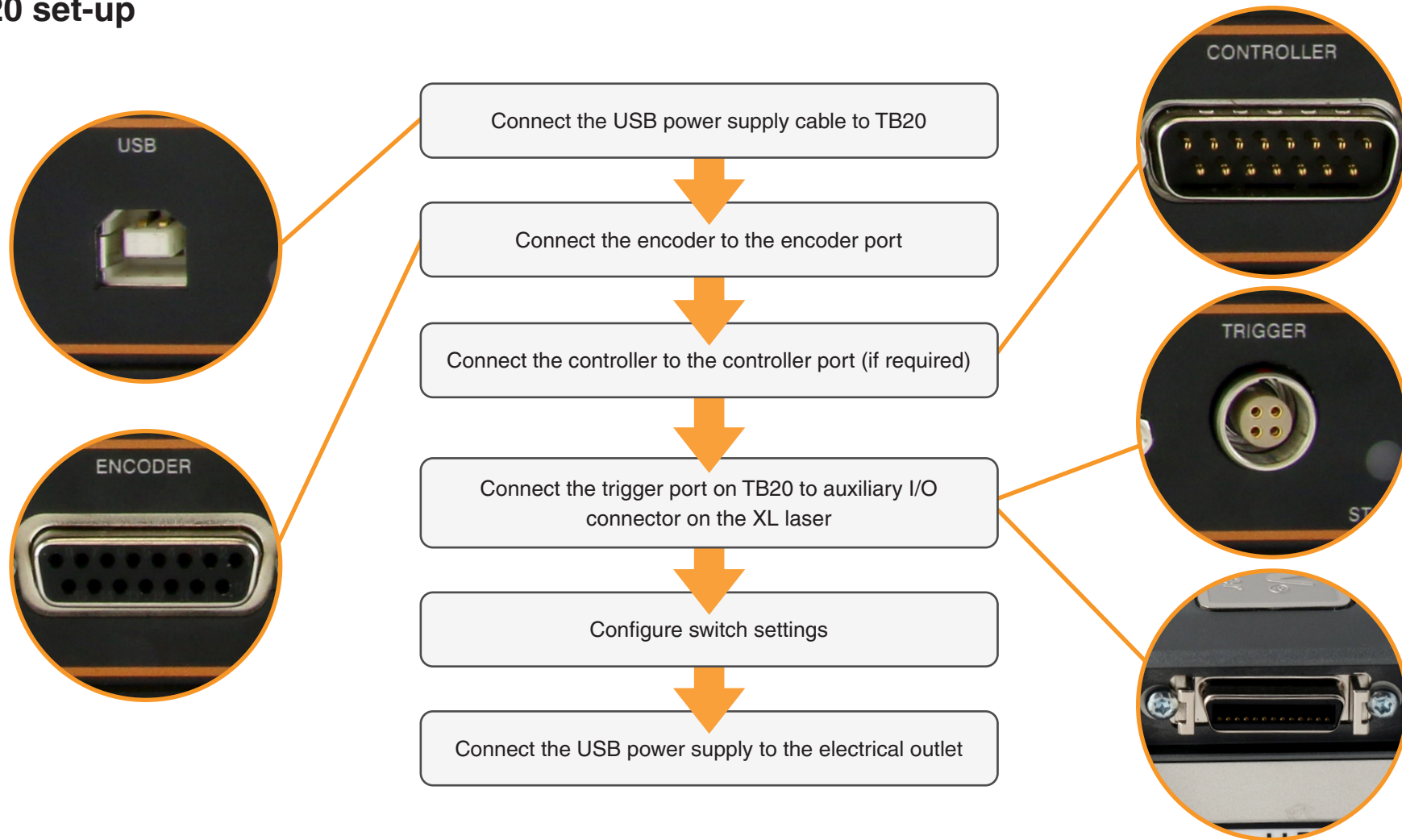

**NOTE:** For TB20 encoder and controller port pin-outs refer to **Appendix A**.



## Trigger interval set-up

To configure the trigger interval on the TB20 the 'trigger interval' switch is used. The input is a decimal value ("00000" is not permitted).

The values for this switch can be set by reference to the table below or by calculation on the following page.

Encoder resolution 5 µm		1 µm		0.5 µm		0.1 µm	
Trigger interval	TB20 setting	Step size	TB20 settings	Step size	TB20 settings	Step size	TB20 settings
10 µm	00001	2 µm	00001	1 µm	00001	0.2 µm	00001
30 µm	00003	6 µm	00003	3 µm	00003	0.6 µm	00003
50 µm	00005	10 µm	00005	5 µm	00005	1 µm	00005
100 µm	00010	20 µm	00010	10 µm	00010	2 µm	00010
300 µm	00030	60 µm	00030	30 µm	00030	6 µm	00030
500 µm	00050	100 µm	00050	50 µm	00050	10 µm	00050
1 mm	00100	200 µm	00100	100µm	00100	20 µm	00100
3 mm	00300	600 µm	00300	300 µm	00300	60 µm	00300
5 mm	00500	1 mm	00500	500 µm	00500	100 µm	00500
10 mm	01000	2 mm	01000	1 mm	01000	200 µm	01000
30 mm	03000	6 mm	03000	3 mm	03000	600 µm	03000
50 mm	05000	10 mm	05000	5 mm	05000	1 mm	05000
100 mm	10000	20 mm	10000	10 mm	10000	2 mm	10000
		60 mm	25000	30 mm	25000	6 mm	25000
		100 mm	50000	50 mm	50000	10 mm	50000



## Trigger interval set-up

For custom trigger interval use the calculation: TB20 setting (in decimal) =  $\frac{\text{desired trigger interval (microns)}}{2 \times \text{encoder resolution (microns)}}$

Where the encoder resolution is defined as:

### RS422 digital quadrature

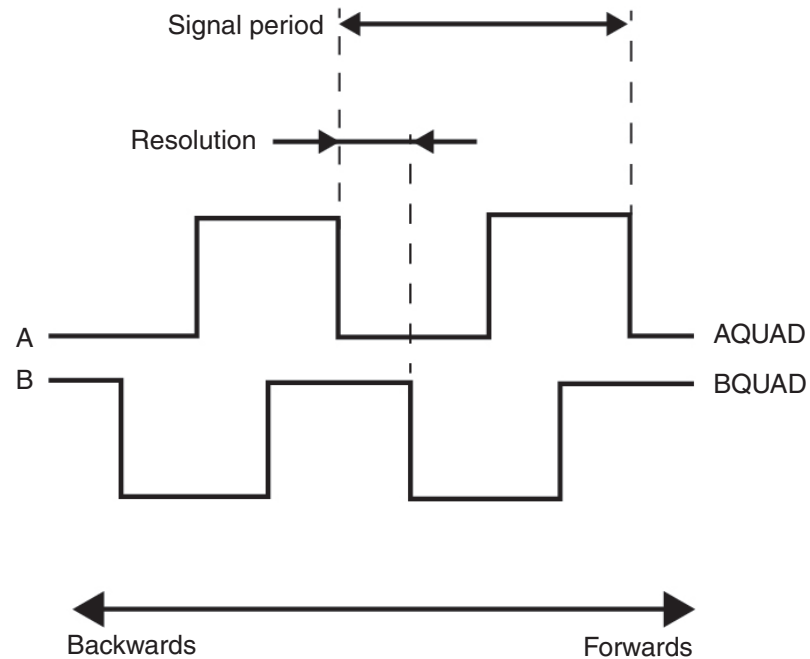

### Analogue quadrature

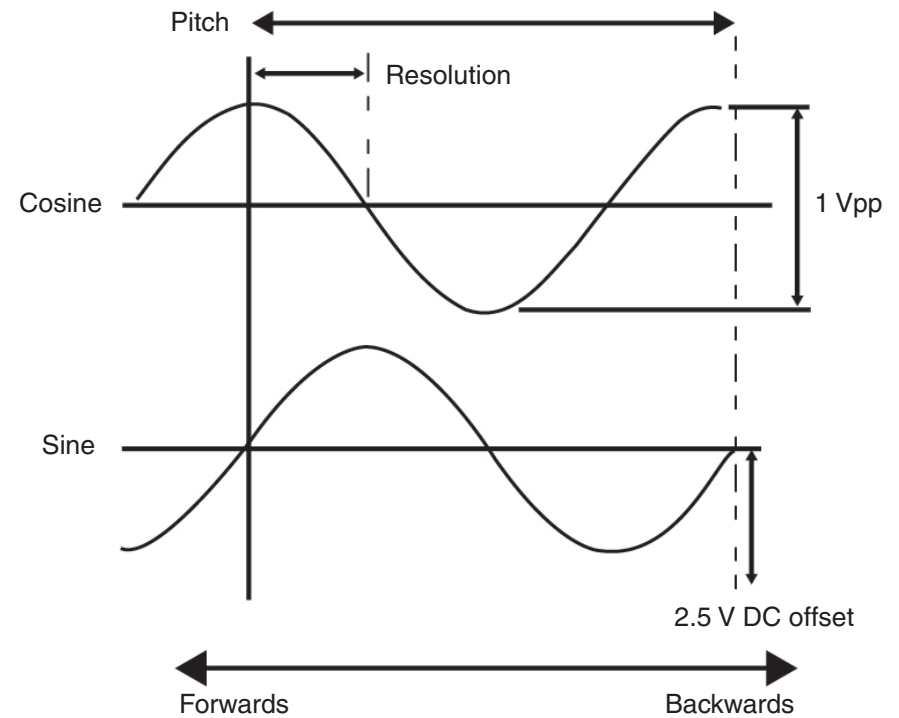



## Switch set-up

The TB20 must be configured to specify the type of encoder connected and the type of trigger required. This is achieved using the 'configuration switches'.



Switch number	1	2	3	4	5	6,7,8
Function	Trigger direction		Encoder type	Encoder type	Trigger period	Reserved
ON	Bidirectional	Backwards	Analogue encoder	10 $\mu$ A analogue	Long (1 ms $\pm$ 1%)*	N/A
OFF	Unidirectional	Forwards	Digital encoder	1 Vpp analogue	Short (10 $\mu$ s $\pm$ 1%)*	

**NOTE:** \* This setting suits connectivity with XL laser and should be interfaced to the fast trigger input on the auxiliary I/O connector on the XL laser.





## Data capture

Two types of data capture can be achieved with TB20 using the XL-80 TPin function:

- Quasi-static – the bed moves via predefined intervals and stops for the measurement to be taken.
- Dynamic – the bed moves continuously and TB20 triggers measurements to be taken.

It is recommended to perform the quasi-static data capture using CARTO Capture, whereas dynamic data capture will require LaserXL software.

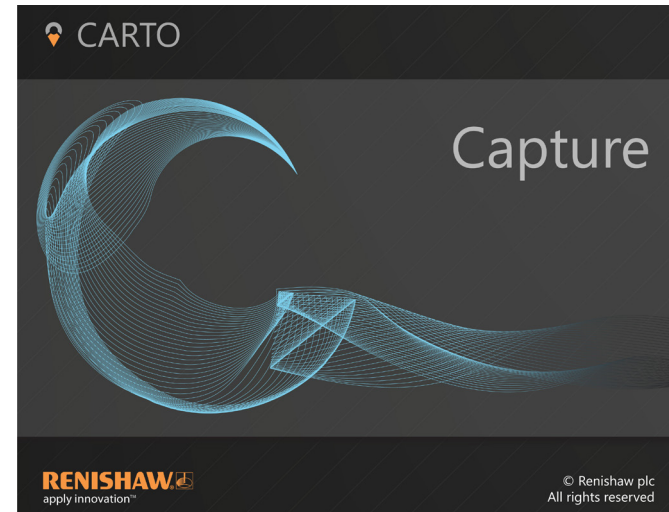

CARTO Capture software

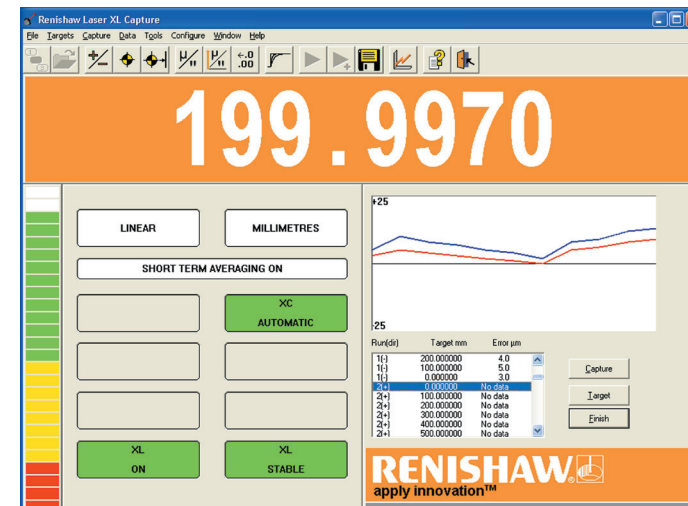

Laser XL software

**NOTE:** For full details on TPin please refer to the *CARTO Capture* user guide (Renishaw product no. F-9930-1007) or the *LaserXL* manual (Renishaw product no. M-9908-9137).

System	Configuration	<b>Data Capture</b>
Data Analysis	Diagnostics	Specifications



## Data capture reset button

The 'RESET' button provides the following functionality:

- Datum and capture the first point at the beginning of a test.
- Clear any error conditions logged by the TB20 (providing the source of the error has been removed).
- Update any changes to switch configurations.



## Quasi-static data capture using CARTO Capture

For full details on Capture please refer to the *CARTO Capture* user guide (Renishaw product no. F-9930-1007).

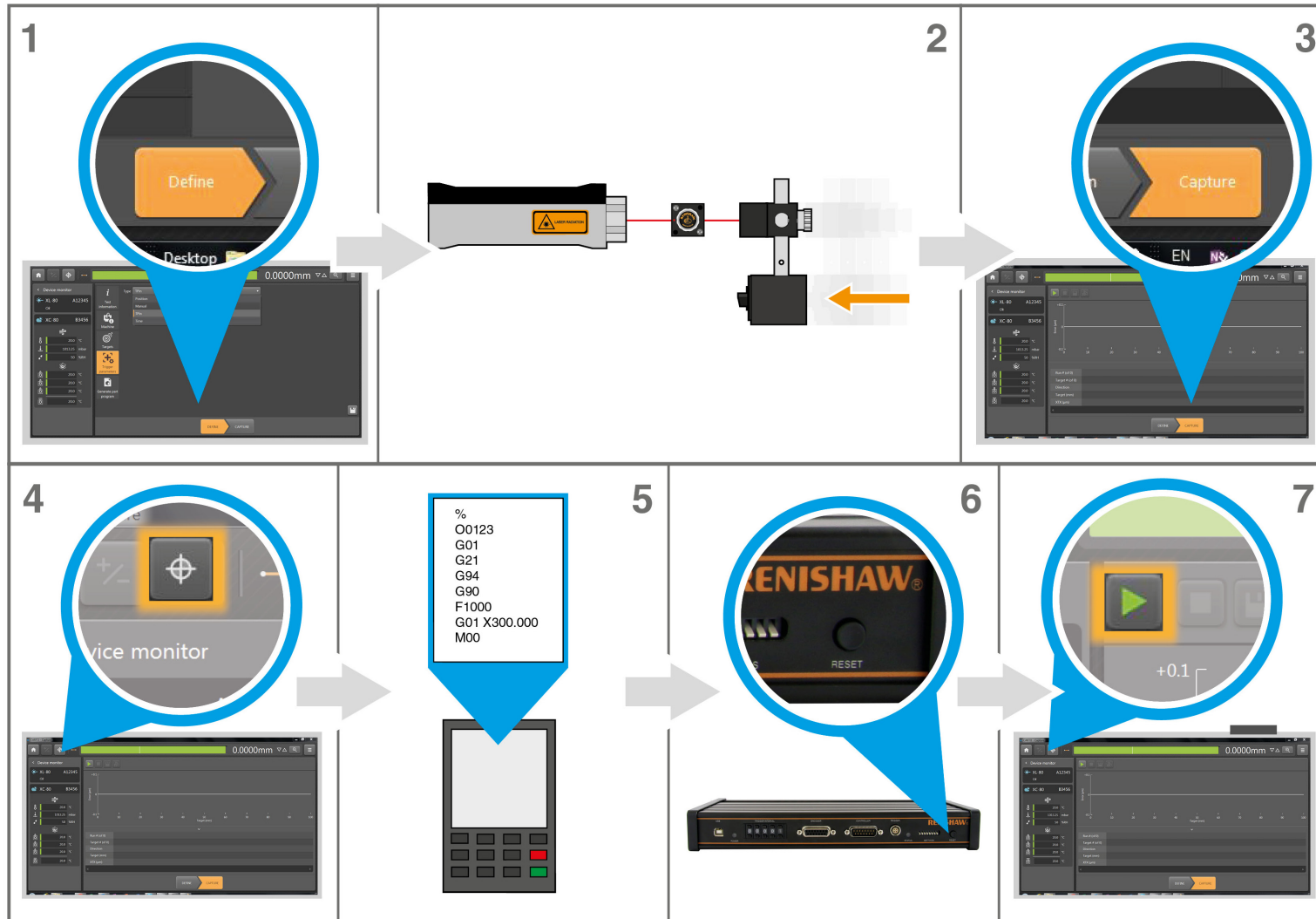



## Dynamic data capture using LaserXL dynamic measurement

For full details on Dynamic data capture and analysis please refer to the *LaserXL* manual (Renishaw product no. M-9908-9137).

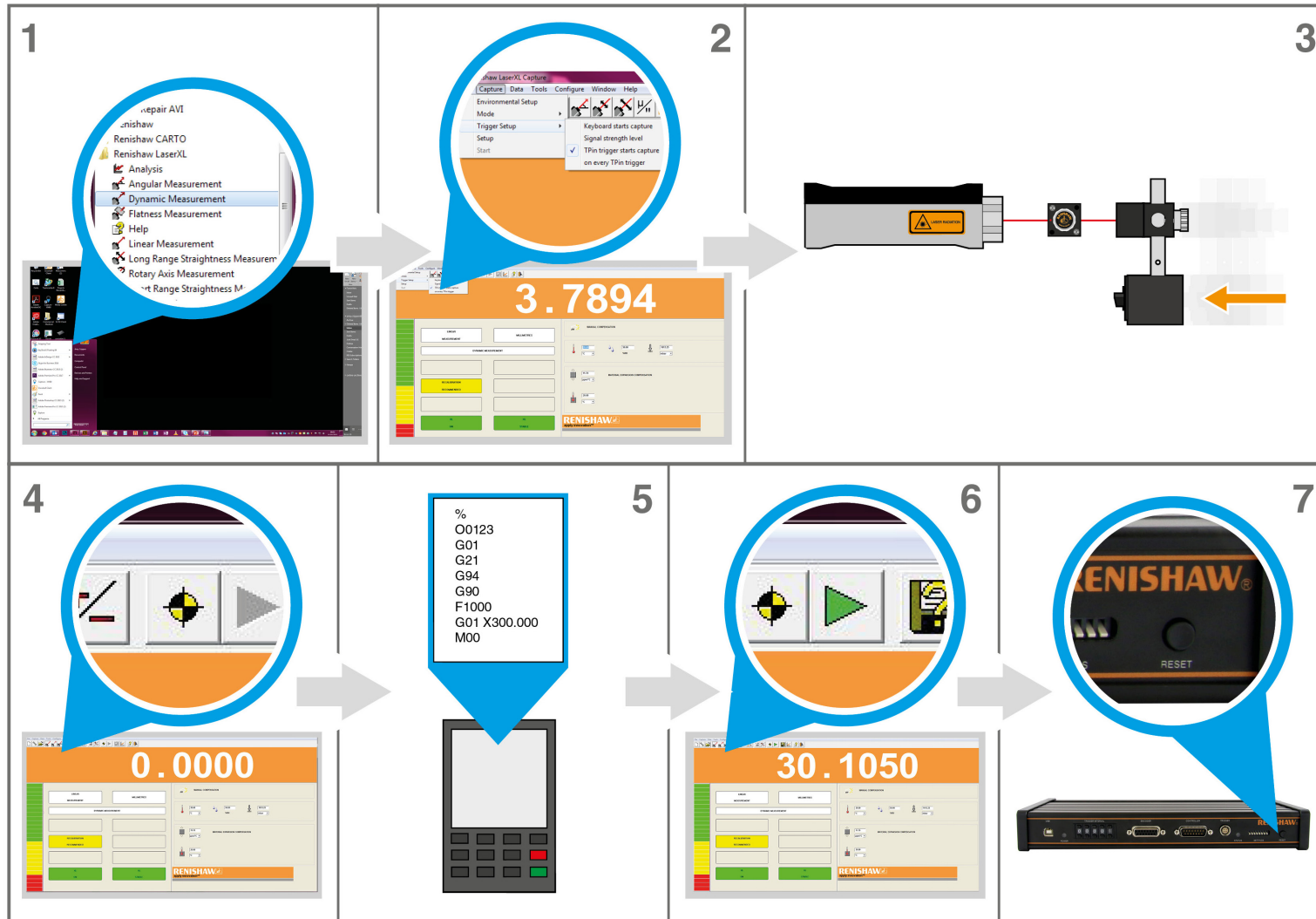



## Data analysis

On completion of the test select 'Analyse' to launch Explore.

**NOTE:** For full details on Explore please refer to the *CARTO Explore* user guide (Renishaw product no. F-9930-1008). Dynamic data capture currently not supported in CARTO. Please refer to XCal-View data analysis software.

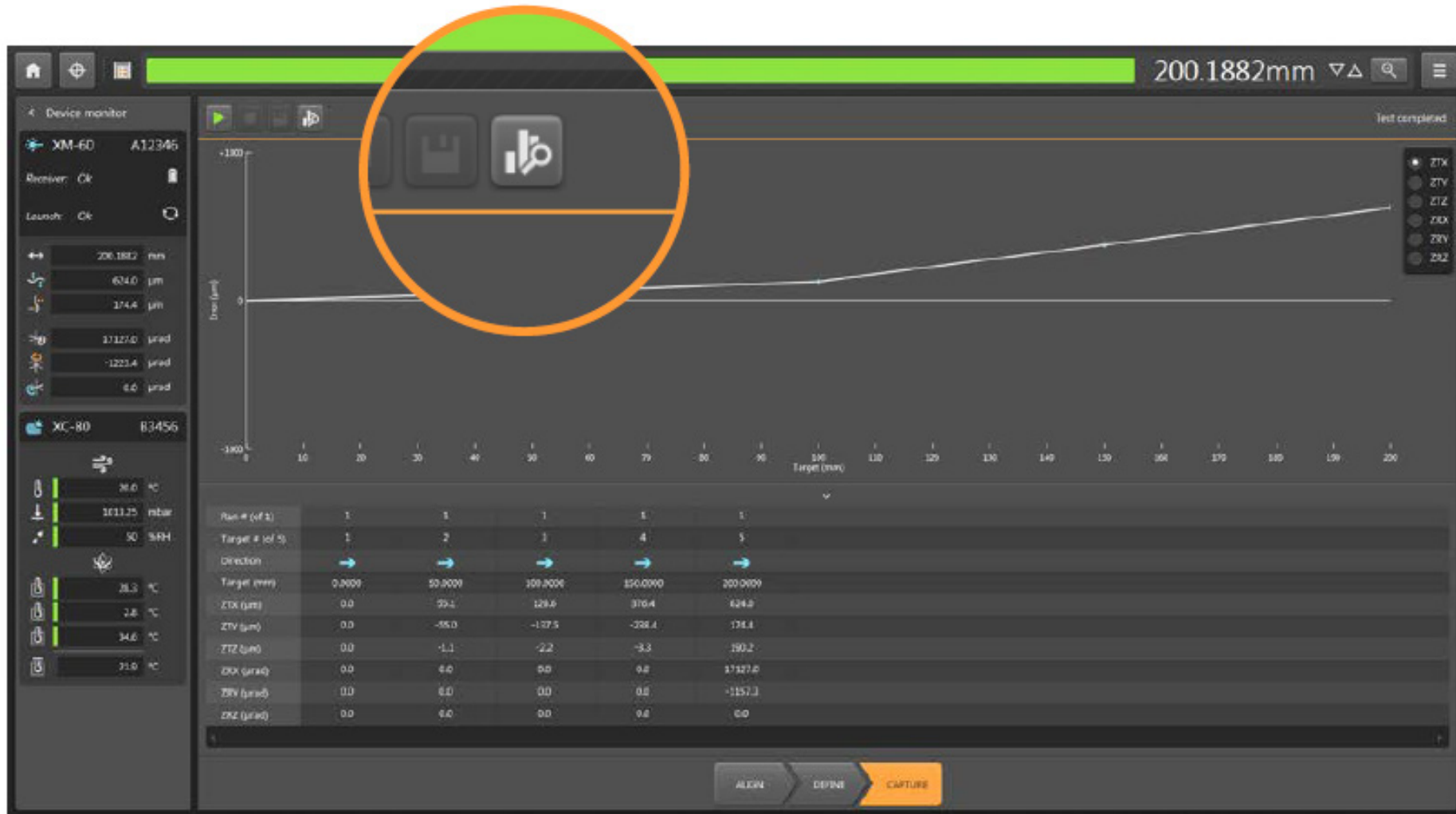



## Diagnostics

### Power LED

The LED identifies the power supply being used.

\* See specification page for more information

LED status		Description
OFF		No power
Green		TB20 and encoder powered by an external USB power supply If controller port is attached to the controller, the TB20 is powered from the USB power supply and encoder from the controller
Blue		TB20 and encoder powered by the controller
Red		TB20 is connected to an invalid power supply (for example, a USB port on a PC)*









## Diagnostics

### Status LED

This LED provides the current status of the TB20.

LED status		Description
Green		Referenced - normal operating mode.
Trigger green		Trigger pulse is generated, green LED alternates between green and grey
Amber		Not referenced – no triggers are generated. This occurs when: <ul style="list-style-type: none"> <li>the interval or configuration switches have been changed</li> <li>unit has just been powered on</li> </ul> Press the reset button to exit this status
Red		Error state. This can happen if: <ul style="list-style-type: none"> <li>Encoder is overspeeding (pulses from encoder occur too quickly or are corrupt)</li> <li>TB20 trigger interval is set to "00000"</li> </ul> Press the reset button to exit this state





## System specifications

Power supply options	External USB power supply (Supplied USB power supply and cable) Controller power port. If the system consists of long cable runs, a sensed power supply configuration can be used to ensure 5 V is present at the encoder by monitoring the voltage drop of the supply cabling through additional cabling. Refer to <b>Appendix A</b> for unsensed and sensed power supply configuration wiring details accordingly.
Input voltage	5 Vdc $\pm$ 5%
Maximum input current	1 A
TB20 current requirement	250 mA (with no encoder connected)
Encoder power supply	5 Vdc $\pm$ 5%, capable of providing 500 mA current to encoder
Encoder and controller connectors	15-way D-type
Safety standard	EN (IEC) 62368-1:2014+A11:2017



System	Configuration	Data Capture
Data Analysis	Diagnostics	Specifications



## Encoder types supported

TB20 is compatible with analogue and digital quadrature encoders that require a 5V power supply. It supports:

- Analogue 1 Vpp encoder
- Analogue microcurrent encoder
- Digital encoder

---

**NOTE:** Refer to the encoder manufacturers installation manual for cabling and shielding recommendations.

---



## Environment

Operating and storage humidity	0% to 95% RH	Non-condensing
Operating temperature	0 °C to 50 °C	
Storage temperature	-20 °C to 70 °C	

## Maximum velocities

The maximum velocity for analogue encoder applications is 1 m/s.

Digital encoder velocities are as follows:

Resolution	Velocity m / s
0.05 µm	0.5
0.1 µm	1
0.5 µm	5



## Weights and dimensions

<b>Weight</b>	TB20: complete kit 1 kg
---------------	-------------------------

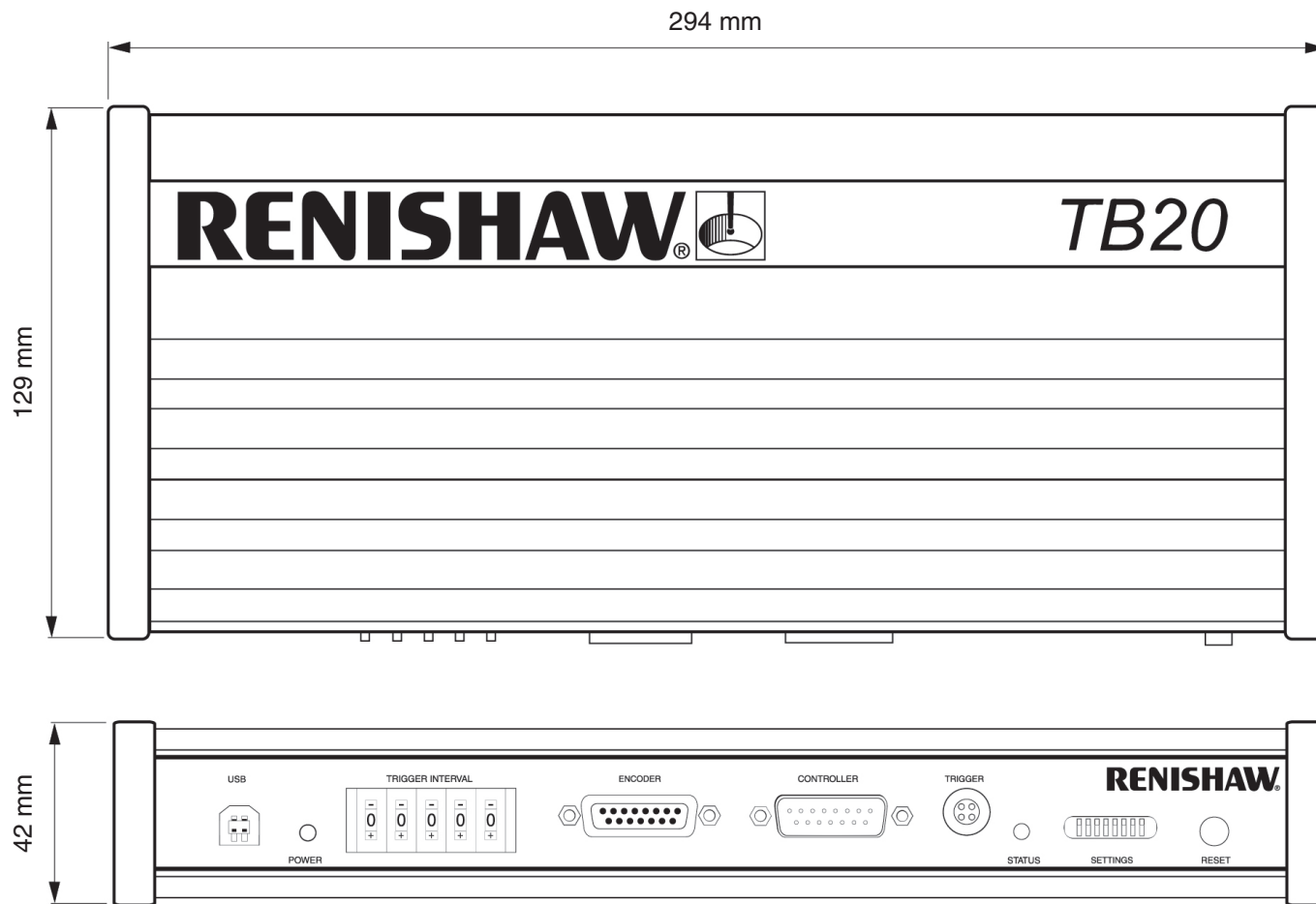

System	Configuration	Data Capture
Data Analysis	Diagnostics	Specifications



## Appendix A – Wiring

The connector pin-outs for the TB20 encoder and controller ports are shown below:

Controller 15 Way D-Type	Encoder 15 Way D-Type	Description
1	1	Spare*
2	2	0 V
3	3	Spare*
4	4	Spare*
5	5	B-
6	6	A-
7	7	5 V
8	8	5 V link**
9	9	0 V link**
10	10	Spare*
11	11	Spare*
12	12	Spare*
13	13	B+
14	14	A+
15	15	Spare*
Shell	Shell	Outer screen – connect to machine earth
* Spare signals are routed straight through and fused at 160 mA via self resetting thermal fuses.		
** Connect 5 V to 5 V link and 0 V to 0 V link at the encoder if a sensed supply is used. The power supply should always be connected to the 5 V and 0 V ports. The TB20 can handle up to 0.5 V drop on both supply and return lines i.e. 5 V $\pm$ 0.5 V maximum. The controller supply should be limited to a maximum output of 6.5 V. Voltage transients above this could cause permanent damage to the encoder. It is recommended that the encoder is never hot-swapped without removing the power from the TB20. Alternatively, if an unsensed supply is used, connect 0 V to 0 V link at the TB20.		



## Appendix B

### Accuracy

The following factors affect the overall accuracy of the measurement:

Use of TB20 introduces no additional factors affecting accuracy of laser measurement.  
For full details please refer to the *XL-80* user guide (Renishaw product no. F-9908-0683).

### Delays in open loop

TB20 introduces a delay in the encoder quadrature signals being received by the controller as per the table below:

#### Quadrature input – trigger delay

Encoder type	Delay (µs)	Effect on accuracy at different speeds (µm)		
		0.25 m/s	0.5 m/s	1 m/s
Analogue 1 Vpp	1.0	0.25	0.5	1
Analogue 10 µA	3.5	0.88	1.75	3.5
Digital	1.0	0.25	0.5	1



## Appendix B

### Accuracy - Delays in closed loop

Quadrature output – trigger delay.

The quadrature signals are regenerated inside the TB20 to be terminated to the machine controller.

Encoder type	Delay ( $\mu$ s)	Effect on accuracy at different speeds ( $\mu$ m)		
		0.25 m/s	0.5 m/s	1 m/s
All	1.0	0.25	0.5	1

The delay between the quadrature output signals at the controller port and the trigger generation:

Quadrature input – Output delay regenerated.

Encoder type	Delay ( $\mu$ s)	Effect on accuracy at different speeds ( $\mu$ m)		
		0.25 m/s	0.5 m/s	1 m/s
Analogue 1 Vpp	0.5	0.25	0.5	1.0
Analogue 10 $\mu$ A	3.0	0.75	1.5	3.0
Digital	0.5	0.125	0.25	0.5

[www.renishaw.com/tb20](http://www.renishaw.com/tb20)

 #renishaw

 +44 (0) 1453 524524

 [uk@renishaw.com](mailto:uk@renishaw.com)

© 2017–2022 Renishaw plc. All rights reserved. This document may not be copied or reproduced in whole or in part, or transferred to any other media or language by any means, without the prior written permission of Renishaw.  
RENISHAW® and the probe symbol are registered trade marks of Renishaw plc. Renishaw product names, designations and the mark 'apply innovation' are trade marks of Renishaw plc or its subsidiaries. Other brand, product or company names are trade marks of their respective owners. Renishaw plc. Registered in England and Wales. Company no: 1106260. Registered office: New Mills, Wotton-under-Edge, Glos, GL12 8JR, UK.

WHILE CONSIDERABLE EFFORT WAS MADE TO VERIFY THE ACCURACY OF THIS DOCUMENT AT PUBLICATION, ALL WARRANTIES, CONDITIONS, REPRESENTATIONS AND LIABILITY, HOWSOEVER ARISING, ARE EXCLUDED TO THE EXTENT PERMITTED BY LAW. RENISHAW RESERVES THE RIGHT TO MAKE CHANGES TO THIS DOCUMENT AND TO THE EQUIPMENT, AND/OR SOFTWARE AND THE SPECIFICATION DESCRIBED HEREIN WITHOUT OBLIGATION TO PROVIDE NOTICE OF SUCH CHANGES.

Part no.: F-8003-4496-02-B  
Issued: 11.2022