

RMP600 (QE) high-accuracy radio machine probe



Compliance information for this product is available by scanning the QR code or visiting www.renishaw.com/mtpdoc



Contents

Before you begin	1-1
Trade marks	1-1
Warranty	1-1
CNC machines	1-1
Care of the probe	1-1
Patents	1-2
RMP600 (model RMP600QE) software notices	1-2
RMP600 (model RMP600QE) software licensing agreement	1-3
Intended use	1-4
Safety	1-4
Information to the user	1-4
Information to the machine supplier/ installer	1-5
Information to the equipment installer	1-5
Equipment operation	1-5
RMP600 basics	2-1
Introduction	2-1
Getting started	2-3
System interface	2-3
Probe configuration	2-4
Opti-Logic™	2-4
Trigger Logic™	2-4
Probe modes	2-5
Configurable settings	2-5
Switch-on / switch-off methods	2-5
Trigger filter	2-7
Auto-reset function	2-7
Hibernation mode	2-8
Multiple probe mode	2-8
Partnering mode	2-9
RMP600 dimensions	2-10
RMP600 specification	2-11
Typical battery life	2-12
Recommended styli	2-13

System installation	3-1
Installing the RMP600 with an RMI-Q or RMI-QE	3-1
Operating envelope	3-1
Positioning the RMP600 and RMI-Q or RMI-QE	3-2
Performance envelope	3-2
Preparing the RMP600 for use	3-3
Fitting the stylus	3-3
Installing the batteries	3-4
Mounting the probe on a shank	3-5
Stylus on-centre adjustment	3-6
Calibrating the RMP600	3-7
Why calibrate a probe?	3-7
Calibrating in a bored hole or on a turned diameter	3-7
Calibrating in a ring gauge or on a datum sphere	3-8
Calibrating the probe length	3-8
 Probe configuration	 4-1
Configuring the probe using the Probe Setup app	4-1
Using Opti-Logic™	4-1
Reviewing the probe settings	4-2
Multiple probe mode settings	4-3
Probe settings record	4-4
Probe partnering function	4-5
With RMI-Q switched on	4-6
With RMI-QE switched on	4-7
RMP600 – RMI-Q partnership	4-8
RMP600 – RMI-QE partnership	4-10
Changing the probe settings when partnered to an RMI-Q	4-12
Changing the probe settings when partnered to an RMI-QE	4-15
Master reset function	4-17
Operating mode	4-20
 Maintenance	 5-1
Maintenance	5-1
Cleaning the probe	5-1
Changing the batteries	5-2
Diaphragm replacement	5-4
 Fault-finding	 6-1
 Parts list	 7-1

Before you begin

Trade marks

Google Play and the Google Play logo are trademarks of Google LLC.

Apple and the Apple logo are trademarks of Apple Inc., registered in the U.S. and other countries. App Store is a service mark of Apple Inc., registered in the U.S. and other countries.

Warranty

Unless you and Renishaw have agreed and signed a separate written agreement, the equipment and/or software are sold subject to the Renishaw Standard Terms and Conditions supplied with such equipment and/or software, or available on request from your local Renishaw office.

Renishaw warrants its equipment and software for a limited period (as set out in the Standard Terms and Conditions), provided that they are installed and used exactly as defined in associated Renishaw documentation. You should consult these Standard Terms and Conditions to find out the full details of your warranty.

Equipment and/or software purchased by you from a third-party supplier is subject to separate terms and conditions supplied with such equipment and/or software. You should contact your third-party supplier for details.

CNC machines

CNC machine tools must always be operated by fully-trained personnel in accordance with the manufacturer's instructions.

Care of the probe

Keep system components clean and treat the unit as a precision tool.

Patents

Features of the RMP600 probe and other similar Renishaw products, are the subject of one or more of the following patents and/or patent applications:

CN 100416216	EP 2216761	JP 5611297	US 8140287
CN 100466003	EP 3688405	JP 7184880	WO 2019/063991
CN 101142461	IN 215787	KR 1001244	WO 2022/185043
CN 101171493	IN 234921	TW I333052	WO 2022/219305
CN 101198836	IN 305341	US 11415412	WO 2022/219306
CN 101476859	IN 307453	US 7285935	WO 2022/219307
CN 101482402	IN 364693	US 7316077	
CN 111133272	JP 5238749	US 7603789	
EP 1457786	JP 5283501	US 7665219	
EP 1576560	JP 5308811	US 7689379	
EP 1613921	JP 5357541	US 7792654	
EP 1866602		US 7821420	
EP 1880163			
EP 1893937			
EP 1931936			
EP 2154471			

RMP600 (model RMP600QE) software notices

This RMP600 product includes embedded software (firmware) to which the following notices apply:

US government notice

NOTICE TO UNITED STATES GOVERNMENT CONTRACT AND PRIME CONTRACT CUSTOMERS

This software is commercial computer software that has been developed by Renishaw exclusively at private expense. Notwithstanding any other lease or licence agreement that may pertain to, or accompany the delivery of, this computer software, the rights of the United States Government and/or its prime contractors regarding its use, reproduction and disclosure are as set forth in the terms of the contract or subcontract between Renishaw and the United States Government, civilian federal agency or prime contractor respectively. Please consult the applicable contract or subcontract and the software licence incorporated therein, if applicable, to determine your exact rights regarding use, reproduction and/or disclosure.

Renishaw software EULA

Renishaw software is licensed in accordance with the Renishaw licence at:
www.renishaw.com/legal/softwareterms

RMP600 (model RMP600QE) software licensing agreement

This RMP600 product includes the following third-party software:

BSD 3-Clause Licence

This product's firmware has been developed by Renishaw with the use of the Microchip libraries, under the following licensing terms:-

This software is developed by Microchip Technology Inc. and its subsidiaries ("Microchip").

Redistribution and use in source and binary forms, with or without modification, are permitted provided that the following conditions are met:

1. Redistributions of source code must retain the above copyright notice, this list of conditions and the following disclaimer.
2. Redistributions in binary form must reproduce the above copyright notice, this list of conditions and the following disclaimer in the documentation and/or other materials provided with the distribution.
3. Microchip's name may not be used to endorse or promote products derived from this software without specific prior written permission.

THIS SOFTWARE IS PROVIDED BY MICROCHIP "AS IS" AND ANY EXPRESS OR IMPLIED WARRANTIES, INCLUDING, BUT NOT LIMITED TO, THE IMPLIED WARRANTIES OF MERCHANTABILITY AND FITNESS FOR PURPOSE ARE DISCLAIMED. IN NO EVENT SHALL MICROCHIP BE LIABLE FOR ANY DIRECT, INDIRECT, INCIDENTAL, SPECIAL, EXEMPLARY, OR CONSEQUENTIAL DAMAGES (INCLUDING BUT NOT LIMITED TO PROCUREMENT OF SUBSTITUTE GOODS OR SERVICES; LOSS OF USE, DATA OR PROFITS; OR BUSINESS INTERRUPTION) HOWSOEVER CAUSED AND ON ANY THEORY OF LIABILITY, WHETHER IN CONTRACT, STRICT LIABILITY, OR TORT (INCLUDING NEGLIGENCE OR OTHERWISE) ARISING IN ANY WAY OUT OF THE USE OF THIS SOFTWARE, EVEN IF ADVISED OF THE POSSIBILITY OF SUCH DAMAGE.

(c) Copyright 1999-2013 Microchip Technology, All rights reserved

Intended use

The RMP600 is a radio spindle probe that enables automated workpiece inspection and job set-up on multi-tasking machines, machining centres and gantry machining centres.

Safety

Information to the user

This product is supplied with non-rechargeable batteries that do not contain lithium. For specific battery operating, safety and disposal guidelines refer to the battery manufacturers' literature.

- Do not attempt to recharge the batteries.
- Replace the batteries only with the specified type.
- Do not mix new and used batteries in the product.
- Do not mix different types or brands of batteries in the product.
- Ensure that all batteries are inserted with the correct polarity in accordance with the instructions in this manual and indicated on the product.
- Do not store the batteries in direct sunlight.
- Do not expose the batteries to water.
- Do not expose the batteries to heat or dispose of the batteries in a fire.
- Avoid forced discharge of the batteries.
- Do not short circuit the batteries.
- Do not disassemble, apply excessive pressure, pierce, deform or subject the batteries to impact
- Do not swallow the batteries
- Keep the batteries out of the reach of children.
- If the batteries are swollen or damaged do not use them in the product and exercise caution when handling them.
- Dispose of waste batteries in accordance with your local environmental and safety laws.

Ensure that you comply with international and national battery transport regulations when transporting the batteries or this product with the batteries inserted. Lithium metal batteries are classified as dangerous goods for transportation and require labelling and packaging in accordance with the dangerous goods regulations before being offered for transportation. To reduce the risk of shipment delays, should you need to return this product to Renishaw for any reason, do not return any batteries.

In all applications involving the use of machine tools, eye protection is recommended.

The RMP600 has a glass window. Handle with care if broken to avoid injury.

Information to the machine supplier/ installer

It is the machine supplier's responsibility to ensure that the user is made aware of any hazards involved in operation, including those mentioned in Renishaw product literature, and to ensure that adequate guards and safety interlocks are provided.

If the probe system fails, the probe signal may falsely indicate a probe seated condition. Do not rely on probe signals to halt the movement of the machine.

Information to the equipment installer

All Renishaw equipment is designed to comply with the relevant UK, EU and FCC regulatory requirements. It is the responsibility of the equipment installer to ensure that the following guidelines are adhered to, in order for the product to function in accordance with these regulations:

- Any interface **MUST** be installed in a position away from any potential sources of electrical noise, (for example power transformers, servo drives).
- All 0 V/ground connections should be connected to the machine "star point" (the "star point" is a single point return for all equipment ground and screen cables). This is very important and failure to adhere to this can cause a potential difference between grounds.
- All screens must be connected as outlined in the user instructions.
- Cables must not be routed alongside high current sources (for example, motor power supply cables), or be near high-speed data lines.
- Cable lengths should always be kept to a minimum.

Equipment operation

If this equipment is used in a manner not specified by the manufacturer, the protection provided by the equipment may be impaired.

This page is intentionally left blank.

RMP600 basics

Introduction

The RMP600 (model RMP600QE) is a new generation radio transmission probe that is compatible for application with either RMI-Q or RMI-QE radio machine interface.



NOTE: Older generation RMP600 probes without the “Model RMP600QE” marking cannot be used with the RMI-QE.

The RMP600 enables automated workpiece inspection and job set-up on multi-tasking machines, machining centres and gantry machining centres.

It offers an unrivalled combination of size, accuracy, reliability and robustness, and allows high-accuracy probing on large machining centres or other machines where line-of-sight problems affect optical signal transmission.

A combination of patented RENGAGE™ strain gauge technology with the use of hybrid FHSS (frequency-hopping spread spectrum) interference-free transmission, the RMP600 provides solid-state strain gauge technology and all the associated benefits this brings:

- Excellent 3D performance to allow probing of contoured surfaces.
- Improved repeatability in all probing directions.
- A low triggering force combined with low pre-travel variation to provide high-accuracy, even when used with long styli.
- The elimination of reseat failures.
- High resistance to machine tool vibration.
- Resistance to shock and false triggering through the use of solid state accelerometers.

In addition to providing high-accuracy measurement on your machine tool, the RMP600 also offers:

- Faster calibration:

On complex 3D parts, it is common to measure in several different directions. Each direction of a standard mechanical probe must be calibrated, to ensure that the pre-travel variation is compensated in the measurement.

Performing this calibration for every 3D direction can be time-consuming.

The RMP600 has almost no pre-travel variation, so a single calibration value may be used for any probing angle in 2D or 3D. This results in a vastly reduced calibration time. An additional benefit is a corresponding reduction in errors introduced by environmental changes within the machine during a long calibration cycle.

- The ability to be used in applications where axial and radial reorientations are used, enabled by the use of solid state accelerometers:

The auto-reset function is required and recommendations should be followed for optimum metrology performance.

All RMP600 settings are configured using either Opti-Logic™ or Trigger Logic™. These techniques enable the user to review and subsequently change probe settings.

Configurable settings are:

- Switch-on / switch-off method
- Trigger filter setting
- Auto-reset function
- Hibernation setting*
- Multiple probe mode*

* in RMI-Q mode only.

Getting started

Three multicolour probe LEDs provide visual indication of selected probe settings and status.

For example:

- Switch-on and switch-off methods
- Probe status – triggered or seated
- Battery condition

Batteries are inserted or removed as shown (for more information, see **page 3-4**, “Installing the batteries”).

On insertion of batteries, the LEDs will begin to flash starting with an LED check (for more information, see **page 4-2**, “Reviewing the probe settings”). An LED check displaying a single flash of red, green, blue indicates that the probe is operating in RMI-Q mode. An LED check displaying double flashes of red, green, blue indicates that the probe is operating in RMI-QE mode.

System interface

The RMI-Q or RMI-QE is an integrated interface/receiver used to communicate between the RMP600 probe and the machine controller. For more details, refer to the *RMI-Q radio machine interface* installation guide (Renishaw part no. H-5687-8504) or the *RMI-QE radio machine interface* installation guide (Renishaw part no. H-6551-8520).

It is necessary that the RMP600 is partnered to either an RMI-Q or RMI-QE. Prior to partnering for the first time, the RMP600 is pre-set to operate in RMI-QE mode. The LED check will display double flashes of red, green, blue.

NOTE: The RMP600 (model RMP600QE) is not compatible with the older RMI integrated interface/receiver.

Probe configuration

It is recommended that the Probe Setup app is used to configure the probe.

The Probe Setup app simplifies the process of configuring Renishaw machine tool probes compatible with Opti-Logic™ or Trigger Logic™ .

The app provides clear, step-by-step, visual instructions and video tutorials to guide a user through the process of setting up and configuring a Renishaw machine tool probing system.

The Probe Setup app is available for download on the App Store and Google Play and also from several app stores in China.



or



Opti-Logic™

Opti-Logic is the process of transmitting and receiving data from the app to a Renishaw machine tool probe using pulses of light; for more information, see page 4-1, “Configuring the probe using the Probe Setup app”.

Trigger Logic™

Trigger Logic™ (for more information, see page 4-2, “Reviewing the probe settings”) is a method that allows the user to view and select all available mode settings in order to customise a probe to suit a specific application. Trigger Logic is activated by battery insertion and uses a sequence of stylus deflections (triggering) to systematically lead the user through the available choices to allow selection of the required mode options.

Current probe settings can also be reviewed by simply removing the batteries for a minimum of 5 seconds, and then replacing them to activate the Trigger Logic review sequence (for more information, **see page 4-2**, “Reviewing the probe settings”).

Probe modes

The RMP600 probe can be in one of three modes:

Standby mode – Probe is waiting for a switch-on signal.

NOTE: The RMP600 will enter hibernation mode should the system interface be powered off or out of range for a period of 30 seconds (hibernation mode is only applicable to “**radio on mode**” when used with an RMI-Q).

Operational mode – When activated by one of the switch-on methods, the probe is switched on and ready for use.

Configuration mode – Ready to change the probe settings using Opti-Logic or Trigger Logic.

Configurable settings

Switch-on / switch-off methods

The following switch-on / switch-off options are user-configurable.

- Radio on / Radio off
- Radio on / Timer off
- Spin on / Spin off
- Spin on / Timer off

RMP600 switch-on method Switch-on options are configurable	RMP600 switch-off method Switch-off options are configurable	Probe ready time
Radio on Radio switch on is commanded by machine input.	Radio off Radio switch off is commanded by machine input. A timer automatically switches the probe off 90 minutes after the last trigger or reseal if it is not turned off by machine input. Timer off (timeout) Timeout will occur 12, 33 or 134 seconds (user-configurable) after the last probe trigger or reseal.	1.4 seconds maximum.
Spin on Spin at 500 r/min for 1 second minimum.	Spin off Spin at 500 r/min for 1 second minimum. A timer automatically switches the probe off 90 minutes after the last trigger if it is not spun. Timer off (timeout) Timeout will occur 12, 33 or 134 seconds (user-configurable) after the last probe trigger or reseal.	2.5 seconds minimum. <hr/> NOTE: The probe must be stationary for 2.5 seconds minimum after it has stopped spinning. <hr/>
Shank switch on	Shank switch off	3 seconds maximum.

NOTES:

In “**radio on mode**”, the switch-on time is user-selectable “fast” or “standard” when using an RMI-Q or RMI-QE (selection is made in the relevant interface).

For more information on the user-selectable switch-on time when operating with RMI-Q or RMI-QE, refer to the *RMI-Q radio machine interface* installation guide (Renishaw part no. H-5687-8504) or the *RMI-QE radio machine interface* installation guide (Renishaw part no. H-6551-8520).

In “**radio on mode**”, the switch-on time assumes a good radio communication link. In a poor radio frequency (RF) environment the switch-on time may increase.

In “**spin on mode**”, the 1 second starts from the moment the spindle reaches 500 r/min.

Timeout off is not applicable in level start mode; refer to the *RMI-Q radio machine interface* installation guide (Renishaw part no. H-5687-8504) or the *RMI-QE radio machine interface* installation guide (Renishaw part no. H-6551-8520).

The RMP600 must be on for a minimum of 1 second before being switched off.

Trigger filter

Probes subjected to high levels of vibration or shock loads may output signals without having contacted any surface. RMP600 trigger filter settings are provided to change the operating configuration to best suit the specific operating conditions of the machine.

Level 1 provides a low latency configuration for measuring in the machine acceleration zone with small approach distances.

Level 2 provides a default configuration for general usage.

Level 3 provides a high false trigger immunity configuration for either manoeuvring to the measuring position at high speed or when measuring with 'heavy' styli at high speed.

Factory set to Level 2.

Auto-reset function

In previous strain gauge products, the probe was required to be turned off during reorientation moves. The auto-reset function in the RMP600 can compensate for stylus forces, resulting from changes in probe orientation, that can cause the probe to trigger.

This feature is controlled by solid state accelerometers and is suitable for applications where axial and radial reorientation of the probe is applied.

To achieve optimum metrology performance when the auto-reset function is turned on, a dwell is recommended before making a programmed move that follows any reorientation of the probe.

When using a stylus of up to 150 mm long, a 0.2 second dwell is necessary. In most applications the machine response time will adequately provide this.

When using a 200 mm long stylus or heavy stylus configurations, a 1 second dwell is required. This will necessitate edits to the machine probing programme.

Hibernation mode

Only applicable to “**radio-on mode**” when an RMP600 is used with an RMI-Q.

When the RMP600 is in standby and the RMI-Q is powered off or out of range, the probe enters hibernation; a low power mode designed to save battery life. The probe “wakes” from hibernation to periodically check for its partnered RMI-Q.

The “wake-up” frequency can be set to 30 seconds, 5 seconds or set to off (the probe never goes into hibernation).

The “wake-up” frequency is factory set to 30 seconds.

If its partnered RMI-Q is found, the RMP600 goes from “**hibernation mode**” to “**standby mode**”, ready for “**radio-on**”

NOTE: “**Hibernation mode**” is not a function of RMP600 (model RMP600QE) when it is used with an RMI-QE.

Multiple probe mode (only applicable when RMP600 is used with RMI-Q)

The RMP600 can be configured, using Trigger Logic, to allow multiple radio probes in “**spin on / spin off**” or “**shank on / shank off**” to be used with a single RMI-Q.

Up to four RMP600 probes can be used with a single RMI-Q or in “**radio on / radio off mode**”. For further details of this functionality, refer to the *RMI-Q radio machine interface* installation guide (Renishaw part no. H-5687-8504).

NOTES:

Multiple probe mode will not appear as an option if the “**radio on**” option has been selected.

RMP600 probes which are set to “**multiple probe mode on**” can coexist alongside any number of RMP600 probes set to “**multiple probe mode off**”.

To allow multiple radio probes to work in close proximity, and with a single RMI-Q, 16 choices of “**mode on**” colours are available, each representing a different machine tool installation (for more information, see **page 4-3**, “Multiple probe mode settings”).

All probes operating with a single RMI-Q must be set to the same “**mode on**” colour choice; any multiple probes located on adjacent machines must all be set to an alternative “**mode on**” colour choice.

NOTE: Each probe per “**mode on**” colour choice must be partnered with the RMI-Q as, by configuring multiple probes to a single “**mode on**” colour choice, all probes using this “**mode on**” colour choice will have the same identity.

The probe is partnered after selecting the multiple probe mode setting and choosing the “**mode on**” option; for more information, see **page 4-12**, “Changing the probe settings when partnered to an RMI-Q”.

There is no limit to the number of probes that can be used with a single RMI-Q as long as they all have the same “**mode on**” colour choice.

All RMP600 probes are factory-set to “**mode off**”.

The addition of any further probe(s) into a single probe installation will require that all probes are reconfigured to the same “**mode on**” colour choice and that one of the probes is then repartnered with the RMI-Q.

The addition of any further probe(s), or replacements, into a multi-probe installation can be achieved through the reconfiguration of the probe to the same “**mode on**” colour choice.

NOTE: “**Multiple probe mode**” does not exist when RMP600 (model RMP600QE) is used with an RMI-QE.

Partnering mode

System set-up is achieved using Opti-Logic or Trigger Logic and powering-on the RMI-Q or RMI-QE. Alternatively “Reniskey” may be used (see notes below).

Partnering is required during initial system set-up. Further partnering is only required if the RMP600, RMI-Q or RMI-QE is changed.

Partnering to an RMI-Q or RMI-QE will configure the RMP600 to operate in either RMI-Q or RMI-QE mode and display specific probe settings accordingly.

The RMP600 operating mode can be determined by observing the LED check that is displayed when the batteries are inserted into the probe (for more information, see **page 4-2**, “Reviewing the probe settings”). Display of “**Hibernation mode**” or “**Multiple probe mode**” menus also indicates that the RMP600 is in RMI-Q mode.

NOTES:

Prior to partnering for the first time, the RMP600 is pre-set to operate in RMI-QE mode. The LED check will display double flashes of red, green, blue.

Systems using the RMI-Q or RMI-QE can be partnered with up to four RMP600 probes manually. Alternatively, partnering to an RMI-Q or RMI-QE, can be achieved by using Reniskey; a Renishaw machine macro cycle which does not require the RMI-Q or RMI-QE to be power cycled.

For more information or to download Reniskey free of charge visit:

www.renishaw.com/mtpsupport/reniskey

Partnering will not be lost by reconfiguration of probe settings or when changing batteries, except where “**multiple probe mode**” is selected.

Partnering can take place anywhere within the operating envelope.

RMP600 dimensions

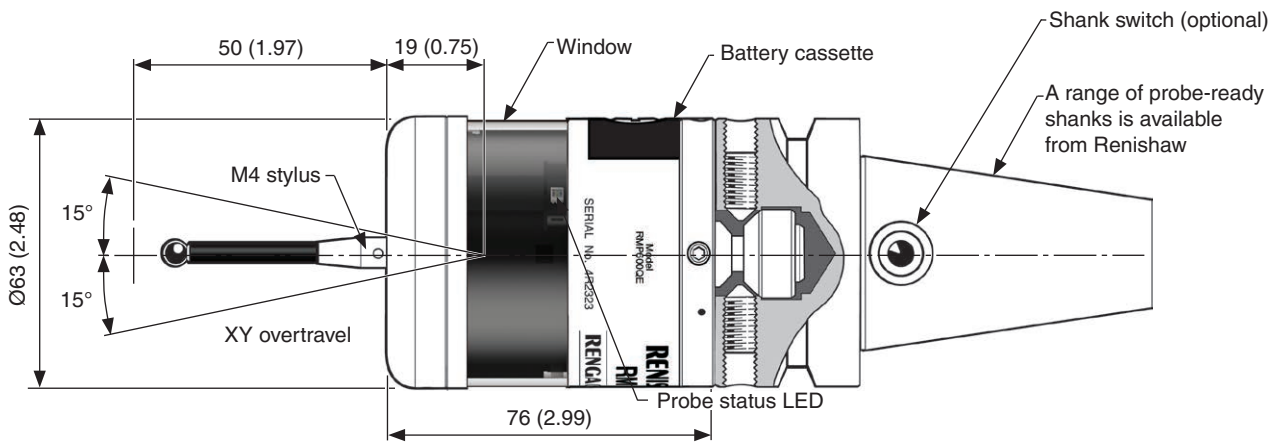

Dimensions given in mm (in)

Stylus overtravel limits		
Stylus length	$\pm X/\pm Y$	+Z
50 (1.97)	18 (0.70)	11 (0.43)
100 (3.94)	31 (1.22)	11 (0.43)

RMP600 specification

Principal application	Workpiece inspection and job set-up on multi-tasking machines, machining centres and gantry machining centres.	
Dimensions	Length	76 mm (2.99 in)
	Diameter	63 mm (2.48 in)
Weight (without shank)	With batteries	1010 g (35.65 oz)
	Without batteries	940 g (33.18 oz)
Transmission type	Frequency-hopping spread spectrum (FHSS) radio	
Radio frequency	2400 MHz to 2483.5 MHz	
Switch-on method	Radio M-code, spin on or shank switch	
Switch-off methods	Radio M-code, timer, spin off or shank switch	
Probe feedrate (minimum)	3 mm/min (0.12 in/min) ¹	
Spindle speed (maximum)	1000 r/min	
Operating range	Up to 15 m (49.2 ft)	
Receiver / interface	RMI-Q or RMI-QE combined antenna, interface and receiver unit	
Sense directions	±X, ±Y, +Z	
Unidirectional repeatability	0.25 µm (10 µin) 2σ – 50 mm stylus length ²	
	0.35 µm (14 µin) 2σ – 100 mm stylus length	
X, Y (2D) form measurement deviation	±0.25 µm (10 µin) – 50 mm stylus length ²	
	±0.25 µm (10 µin) – 100 mm stylus length	
X, Y, Z (3D) form measurement deviation	±1.00 µm (40 µin) – 50 mm stylus length ²	
	±1.75 µm (70 µin) – 100 mm stylus length	
Stylus trigger force³		
XY plane (typical minimum)	0.10 N, 10 gf (0.72 ozf). Trigger filter (Level 2)	
+Z plane (typical minimum)	1.22 N, 124 gf (6.83 ozf). Trigger filter (Level 3)	
Stylus overtravel force		
XY plane (typical minimum)	2.8 N, 285 gf (10.07 ozf) typical minimum ⁴	
+Z plane (typical minimum)	9.8 N, 999 gf (35.25 ozf) typical minimum ⁵	
Stylus overtravel	XY plane	±15°
	+Z plane	11 mm (0.43 in)

¹ Speeds below 3 mm/min commonly occur when manually moving the probe using the handwheel with a very fine feedrate.

² Performance specification is tested at a standard test velocity of 240 mm/min (9.45 in/min) with a 50 mm carbon fibre stylus. Significantly higher velocity is possible depending on application requirements.

³ Trigger force, which is critical in some applications, is the force exerted on the component by the stylus when the probe triggers. The maximum force applied will occur after the trigger point (overtravel). The force value depends on related variables including measuring speed, machine deceleration and latency.
RENGAGE™ equipped probes offer ultra-low trigger forces when probing at low feedrates. Tested at the lowest recommended feedrate of 3 mm/min (minimum).

⁴ Stylus overtravel force in the XY plane occurs 80 µm (3149.61 µin) after the trigger point and rises by 0.35 N/mm, 36 gf/mm (32 ozf/in) until the machine tool stops (in the high force direction and using a 50 mm carbon fibre stylus).

⁵ Stylus overtravel force in +Z direction occurs 7 µm to 8 µm (275.59 µin to 314.96 µin) after the trigger point and rises by 1.5 N/mm, 153 gf/mm (137 ozf/in) until the machine tool stops.

Environment	IP rating	IPX8, BS EN 60529:1992+A2:2013
	IK rating (typical)	IK01 BS EN IEC 62262: 2002 [for glass window]
	Storage temperature	-25 °C to +70 °C (-13 °F to +158 °F)
	Operating temperature	+5 °C to +55 °C (+41 °F to +131 °F)
Battery types	2 × AA 1.5 V alkaline or 2 × AA 3.6 V lithium-thionyl chloride (LTC)	
Battery reserve life	Approximately one week after a low battery warning is first given (based on 5% usage)	
Typical battery life	See the table on page 2-12	

Typical battery life

Typical battery type		2 × AA 3.6 V LTC			
Typical battery life		Radio on		Spin on	Shank on
		(1 s turn-on)	0.5 s turn-on)		
	Standby life	116 months	70 months	75 months	141 months
	Light usage 1%	45 months	36 months	36 months	46 months
	Heavy usage 5%	13 months	12 months	12 months	13 months
Continuous use	540 hours	540 hours	500 hours	500 hours	

Typical battery type		2 × AA 1.5 V alkaline			
Typical battery life		Radio on		Spin on	Shank on
		(1 s turn-on)	0.5 s turn-on)		
	Standby life	46 months	26 months	31 months	87 months
	Light usage 1%	18 months	14 months	14 months	20 months
	Heavy usage 5%	5 months	5 months	5 months	5 months
Continuous use	200 hours	200 hours	190 hours	190 hours	

NOTES:

Battery life figures quoted in the above table are applicable to RMP600 (model RMP600QE) when used in conjunction with an RMI-QE interface/receiver.

Using with an RMI-Q interface/receiver will result in a reduction from the figures quoted.

Using an RMP600 with “fast radio on” mode will result in a 5% reduction in usage and standby battery life.

1% usage = 14 minutes/day.

5% usage = 72 minutes/day.

Battery life is dependent on the quality of the external RF environment in which the probing system is operating.

Recommended styli

High modulus carbon fibre styli are designed to minimise pre-travel and improve accuracy, as the stem material is extremely stiff. This inherent stiffness makes the following styli most suitable for strain gauge applications.

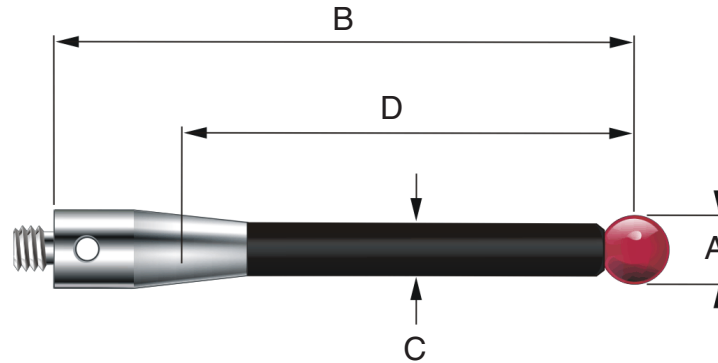

Part number	A-5003-7306 Carbon fibre	A-5003-6510 Carbon fibre	A-5003-6511 Carbon fibre	A-5003-6512 Carbon fibre
A Ball diameter mm (in)	6.0 (0.24)	6.0 (0.24)	6.0 (0.24)	6.0 (0.24)
B Length mm (in)	50.0 (1.97)	100.0 (3.94)	150.0 (5.91)	200.0 (7.88)
C Stem diameter mm (in)	4.5 (0.18)	4.5 (0.18)	4.5 (0.18)	4.5 (0.18)
D EWL mm (in)	38.5 (1.52)	88.5 (3.48)	138.5 (5.45)	188.5 (7.42)
Mass g (oz)	4.1 (0.14)	6.2 (0.22)	7.5 (0.26)	8.7 (0.31)

The featured range of solid carbon fibre styli ensure the best possible performance of the RMP600.

It is possible that the featured range of solid carbon fibre styli may not be suitable for every RMP600 application and that it may be necessary to select specialised styli configurations to meet specific application requirements.

In applications where specialised styli are to be used, it may be beneficial to reduce the speed of probing moves. It has been seen in some cases that specialist styli configurations do not exhibit the probing characteristics and performance that would have otherwise been expected and achieved when using standard styli. Reducing the speed of the probing move may, in some cases, improve the performance of the probe.

When selecting components for an application specific stylus, it is recommended that a configuration with the least number of components is chosen. The stylus diameter should always be as large as possible and the overall stylus length kept to a minimum. If a stem with a reduced diameter is required, then it is recommended that an M4 stem with a short length and reduced diameter is selected.

This page is intentionally left blank.

System installation

Installing the RMP600 with an RMI-Q or RMI-QE

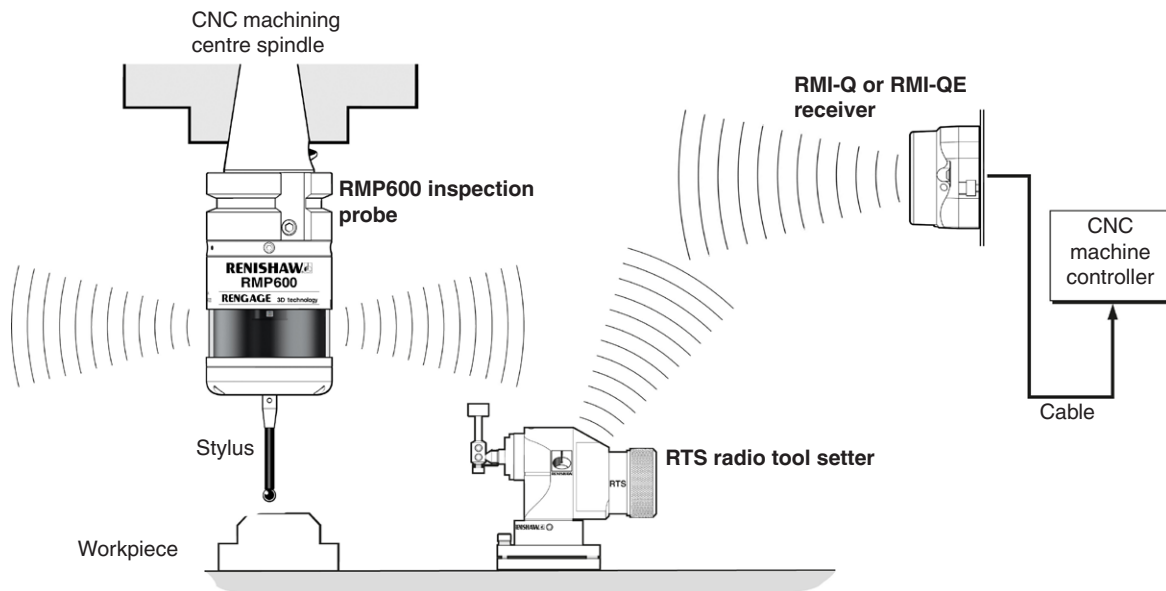

Operating envelope

Radio transmission does not require line-of-sight between the probe and interface as it works via reflected paths, and will pass through very small gaps and machine tool windows. This allows easy installation inside the machine, as long as the probe and RMI-Q or RMI-QE are kept within the performance envelope shown overleaf.

Coolant and swarf residue accumulating on the RMP600 and RMI-Q or RMI-QE may have a detrimental effect on transmission performance. Wipe clean as often as is necessary to maintain unrestricted transmission.

When operating, do not cover the probe glass window, RMI-Q, or RMI-QE with your hands, as this will affect the performance.

Positioning the RMP600 and RMI-Q or RMI-QE

The probe system should be positioned so that the optimum range can be achieved over the full travel of the machine's axes. Always face the front cover of the RMI-Q or RMI-QE in the general direction of the machining area and the tool magazine, ensuring both are within the performance envelope shown below. To assist in finding the optimum position of the RMI-Q or RMI-QE, the signal quality is displayed on an RMI-Q or RMI-QE signal LED.

NOTES:

Installing the RMP600 and RMI-Q or RMI-QE

The RMP600 has a built-in hibernation mode (battery-saving mode) that saves battery life when the RMI-Q is unpowered in **“radio-on” (radio-off or timer-off)** configurations. The RMP600 goes into hibernation mode 30 seconds after the RMI-Q is unpowered (or the RMP600 is out of range). When in hibernation mode, the RMP600 checks for a powered RMI-Q every 30 seconds. If found, the RMP600 goes from hibernation mode to standby mode, ready for **“radio-on”**.

Hibernation mode does not exist when RMP600 (model RMP600QE) is used with an RMI-QE.

Performance envelope

The RMP600 and RMI-Q or RMI-QE must be within each other's performance envelope, as shown below. The performance envelope shows line-of-sight performance, however, this is not necessary for the RMP600 radio transmission as it will operate with any reflected radio path provided that the reflected path length does not exceed the 15 m (49.2 ft) operating range.

Performance envelope when using the RMP600 with the RMI-Q or RMI-QE

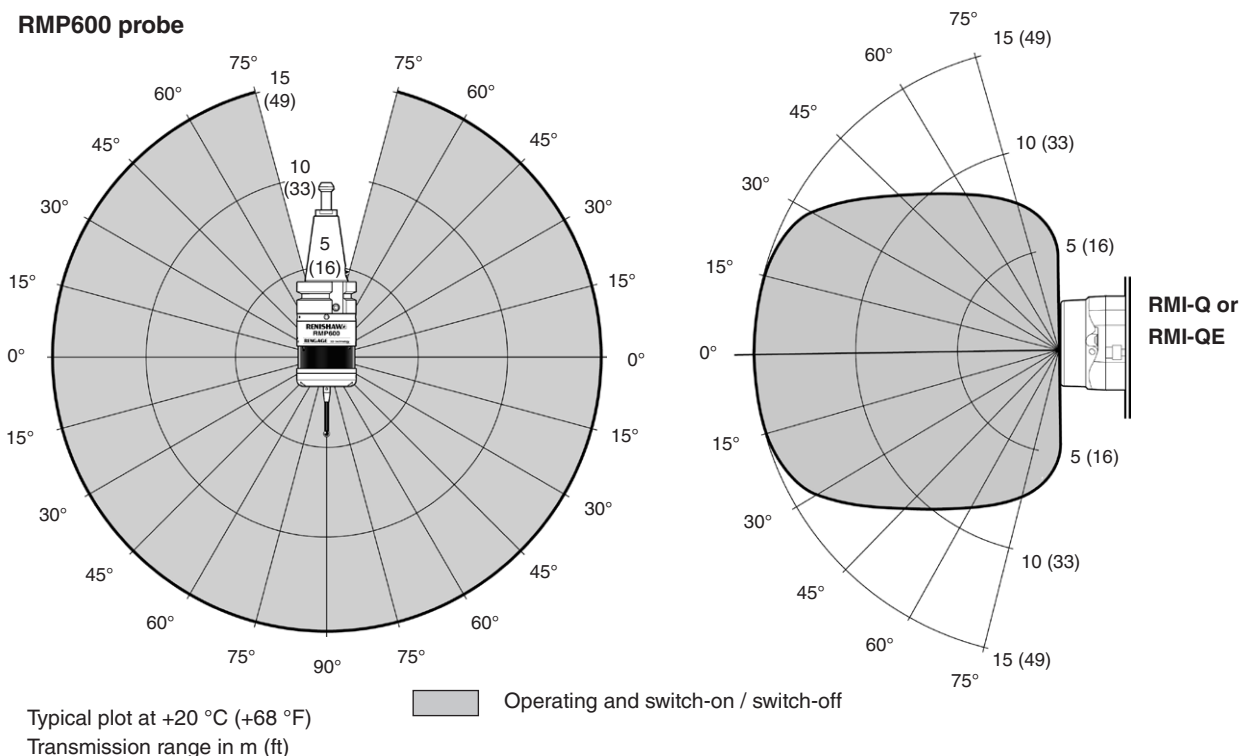

Preparing the RMP600 for use

Fitting the stylus

1



2



M-5000-3707

Installing the batteries

NOTES:

Ensure the product is clean and dry before inserting batteries.

Do not allow coolant or debris to enter the battery compartment.

When inserting batteries, check that the battery polarity is correct.

After the batteries have been inserted, the LED will display the current probe settings (for more information, see **page 4-2**, “Reviewing the probe settings”).

For more information and a list of suitable battery types, see **page 5-2**, “Changing the batteries”.



Mounting the probe on a shank

NOTE: Where the RMP600 is to be used with a shank switch, remove the plug from the rear of the probe using pliers and replace it with the bobbin (A-4038-0303).

1



2

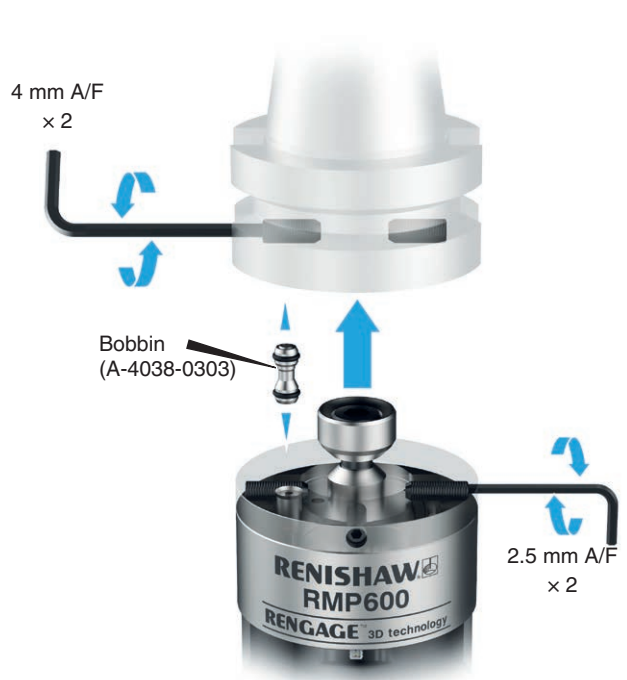

3



Stylus on-centre adjustment

NOTES:

If a probe and shank assembly is dropped, it must be rechecked for correct on-centre adjustment.

Do not hit or tap the probe to achieve on-centre adjustment.



Calibrating the RMP600

Why calibrate a probe?

A spindle probe is just one component of the measurement system which communicates with the machine tool. Each part of the system can introduce a constant difference between the position that the stylus touches and the position that is reported to the machine. If the probe is not calibrated, this difference will appear as an inaccuracy in the measurement. Calibration of the probe allows the probing software to compensate for this difference.

During normal use, the difference between the touch position and the reported position does not change, but it is important that the probe is calibrated in the following circumstances:

- when a probe system is to be used for the first time;
- when the trigger filter delay is changed;
- when a new stylus is fitted to the probe;
- when it is suspected that the stylus has become distorted or that the probe has been crashed;
- at regular intervals to compensate for mechanical changes of your machine tool;
- if repeatability of relocation of the probe shank is poor. In this case, the probe may need to be recalibrated each time it is selected.

It is good practice to set the tip of the stylus on-centre, because this reduces the effect of any variation in spindle and tool orientation (see **page 3-6**, “Stylus on-centre adjustment”, for further information). A small amount of run-out is acceptable, and can be compensated for as part of the normal calibration process.

Three different operations are to be used when calibrating a probe. They are:

- calibrating either in a bored hole or on a turned diameter of known position;
- calibrating either in a ring gauge or on a datum sphere;
- calibrating the probe length.

Calibrating in a bored hole or on a turned diameter

Calibrating a probe, either in a bored hole or on a turned diameter of known size, automatically stores values for the offset of the stylus ball to the spindle centre line. The stored values are then used automatically in the measuring cycles. Measured values are compensated by these values so that they are relative to the true spindle centre line.

Calibrating in a ring gauge or on a datum sphere

Calibrating a probe either in a ring gauge or on a datum sphere with a known diameter automatically stores one or more value for the radius of the stylus ball. The stored values are then used automatically by the measuring cycles to give the true size of the feature. The values are also used to give true positions of single surface features.

NOTE: The stored radius values are based on the true electronic trigger points. These values are different from the physical sizes.

Calibrating the probe length

Calibrating a probe on a known reference surface determines the length of the probe, based on the electronic trigger point. The stored value for length is different from the physical length of the probe assembly. Additionally, the operation can automatically compensate for machine and fixture height errors by adjusting the probe length value that is stored.

Probe configuration

Configuring the probe using the Probe Setup app

The Probe Setup app simplifies the process of configuring Renishaw machine tool probes compatible with Opti-Logic™ or Trigger Logic™.

The app provides clear, step-by-step, visual instructions and video tutorials to guide a user through the process of setting up and configuring a Renishaw machine tool probing system.

Using Opti-Logic™

Opti-Logic™ is the process of transmitting and receiving data from the app to a Renishaw machine tool probe using pulses of light. The app will ask for the probe version to be entered. The probe version is displayed at the back of the battery compartment which is visible when the battery cassette is removed.

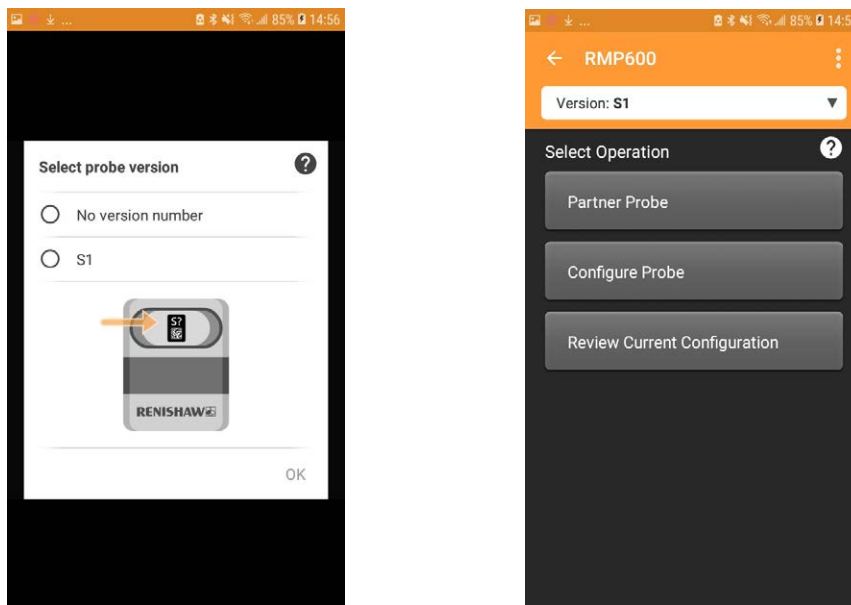

The Probe Setup app is available for download on the App Store and Google Play and several app stores in China.



Multiple probe mode settings

(RMI-Q application only)

Deflect the stylus for less than 4 seconds to cycle to the next setting.

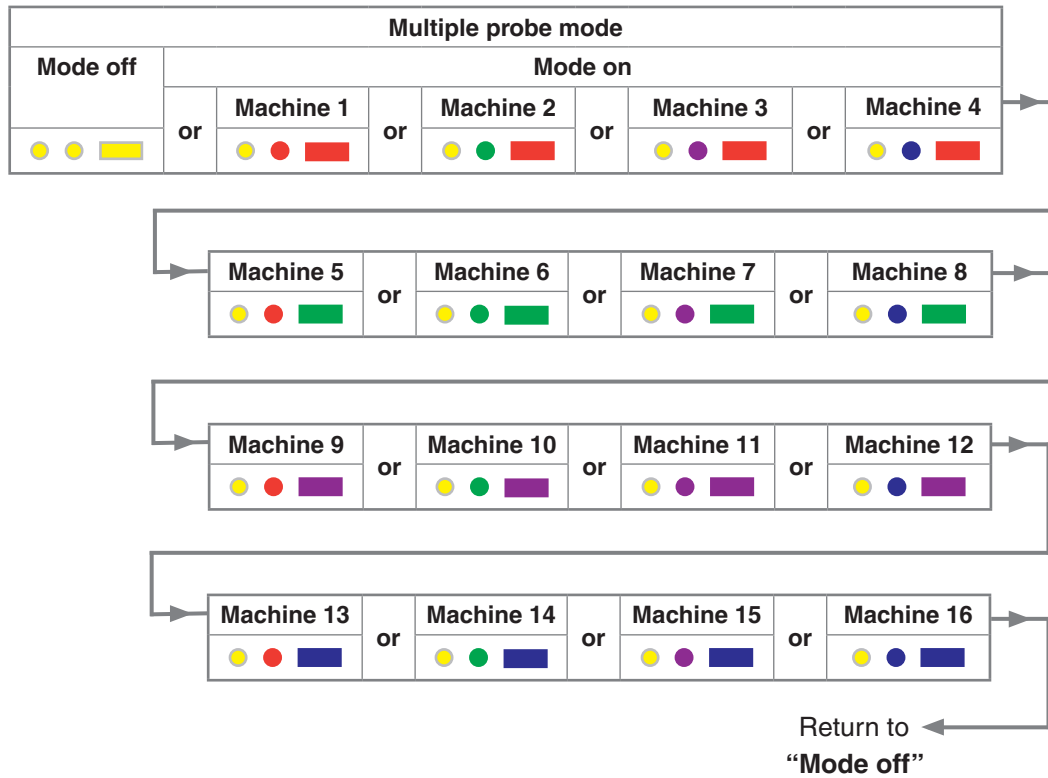

Probe settings record

This page is provided to note your probes settings.

 tick

			Factory settings	New settings
Switch-on method	Radio on			
	Shank on			
	Spin on			
Switch-off method	Radio off, spin off or shank off			
	Short timeout (12 s)			
	Medium timeout (33 s)			
	Long timeout (134 s)			
Trigger filter	Level 1 (low latency)			
	Level 2 (general usage)			
	Level 3 (high vibration resistance)			
Auto-reset function	Auto-reset off			
	Auto-reset on			
Hibernation mode setting (RMI-Q only)	On (30 s)			
	On (5 s)			
	Off			
Multiple probe mode (RMI-Q only)	Off (factory set)			
	On (machine number)	See “ Multiple probe settings ”		

Factory settings are for kit A-6554-0001 only.

RMP600 serial no

Probe partnering function

The probe partnering function enables the RMP600 to be partnered with an RMI-Q or RMI-QE interface independently of the configuration process for other probe settings. To partner an RMP600 with an RMI-Q or RMI-QE, insert the batteries or, if they have already been installed, remove them for 5 seconds and then refit them.

Following the LED check, the RMP600 will proceed to show the probe settings. This will end with **“Battery status”** being displayed. If the battery power is good, battery status will be eight green flashes. If battery power is low, each green flash will be followed by a blue flash.

Whilst the **“Battery status”** is being displayed, deflect and immediately release the stylus to enter **“Partnering mode”**.

“Partnering mode off” will be displayed as a sequence of light blue flashes. At this point the RMI-Q or RMI-QE must be turned on.

If an RMI-Q is turned on, the RMP600 will continue to display the sequence of light blue flashes. If an RMI-QE is turned on, the RMP600 display sequence will now incorporate a long yellow flash.

On the RMP600 select **“Partnering mode active”** by deflecting the stylus for less than 4 seconds. After successful partnering indicated by a light blue, light blue, green flash, the RMP600 will timeout after 20 seconds and then go into standby. If **“Partnering mode active”** is not selected, the RMP600 will timeout after 120 seconds and then go into standby (see **page 4-8**, “RMP600 – RMI-Q partnership”, or **page 4-10**, “RMP600 – RMI-QE partnership”, for further information).

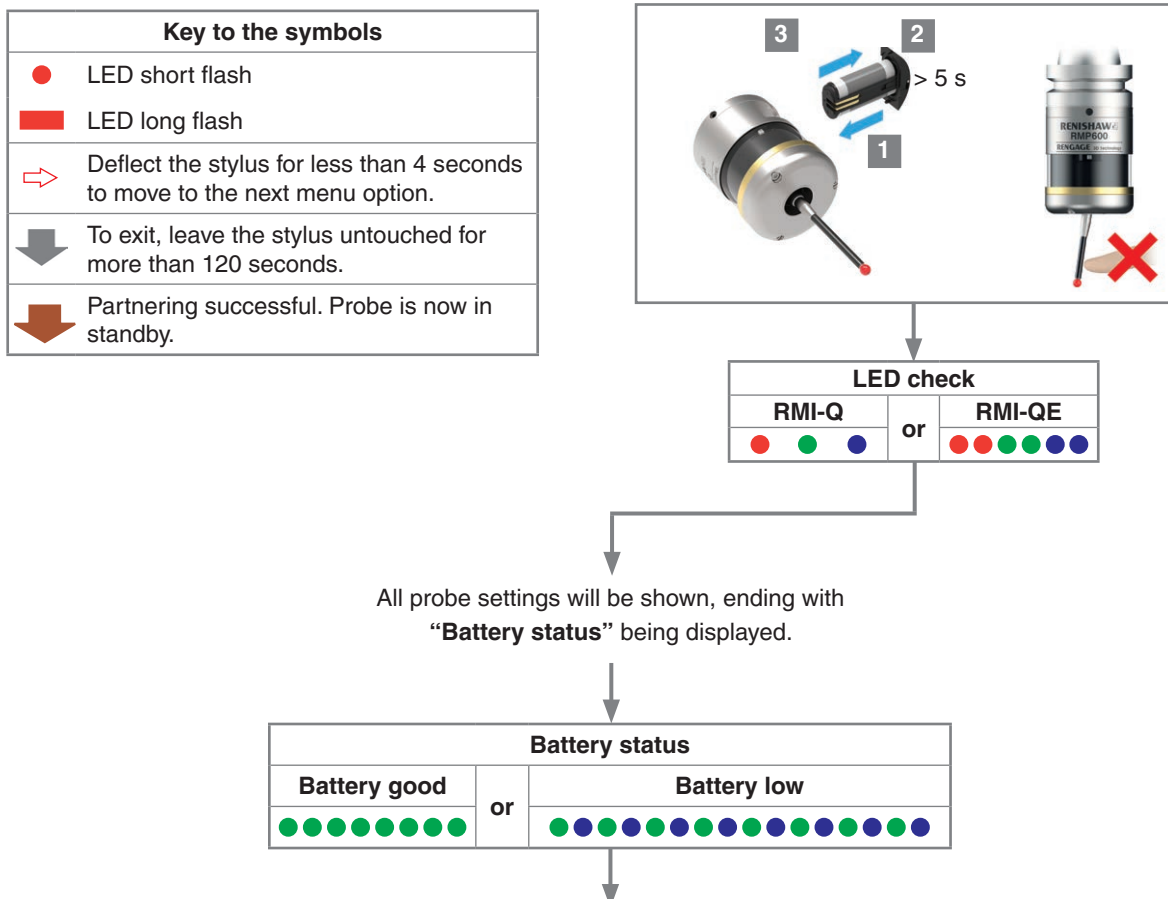

Whilst the **"Battery status"** is being displayed, deflect and release the stylus to enter **"Partnering mode"**. Probe status will flash red to acknowledge this.

NOTE: Wait until the first battery status flash has occurred before deflecting the stylus, and then release the stylus when the red flash is observed. Ensure this is done before the last battery status flash is displayed.

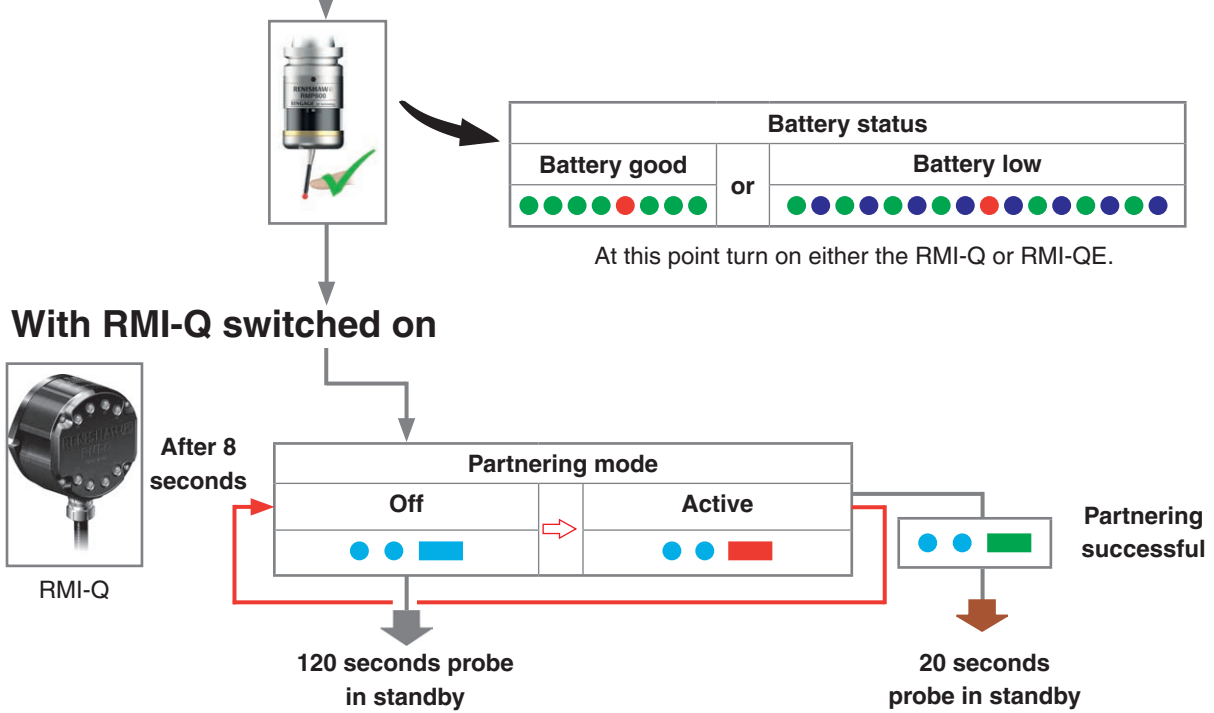

If partnering is unsuccessful **"Partnering mode off"** will be displayed again after 8 seconds. Deflect the stylus for less than 4 seconds to select **"Partnering mode active"** again.

or

With RMI-QE switched on

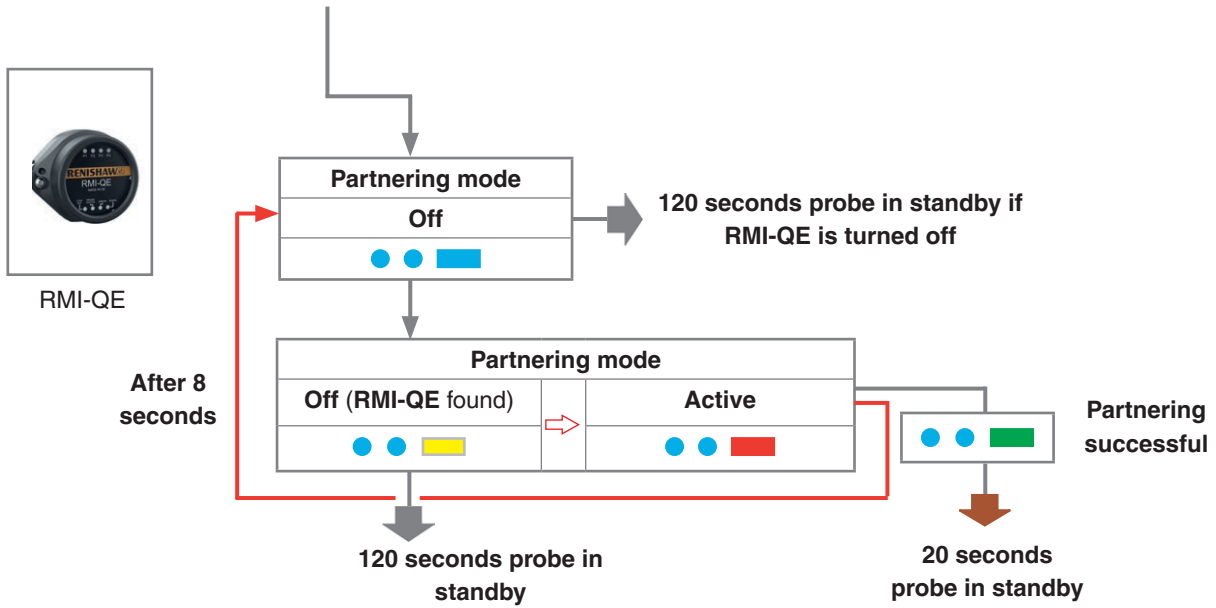

If partnering is unsuccessful **“Partnering mode off”** will be displayed again after 8 seconds.
When **“Partnering mode off (RMI-QE found)”** is displayed, deflect the stylus for less than 4 seconds to select **“Partnering mode active”** again.

RMP600 – RMI-Q partnership

System set-up is achieved by using Trigger Logic™ and powering on the RMI-Q. Alternatively, partnering to an RMI-Q can be achieved by using ReniKey; a Renishaw machine macro cycle which does not require the RMI-Q to be power cycled.

Partnering is required during initial system set-up. Further partnering will be required if either the RMP600 or RMI-Q is changed.

Partnering will not be lost by reconfiguring the probe settings or changing the batteries. Partnering can take place anywhere within the operating envelope.

The RMP600 should be operated with only one partnered RMI-Q being active (powered).

In configuration mode, configure the probe settings as required until you reach the “**Partnering mode**” menu, which defaults to “**Partnering mode off**”.

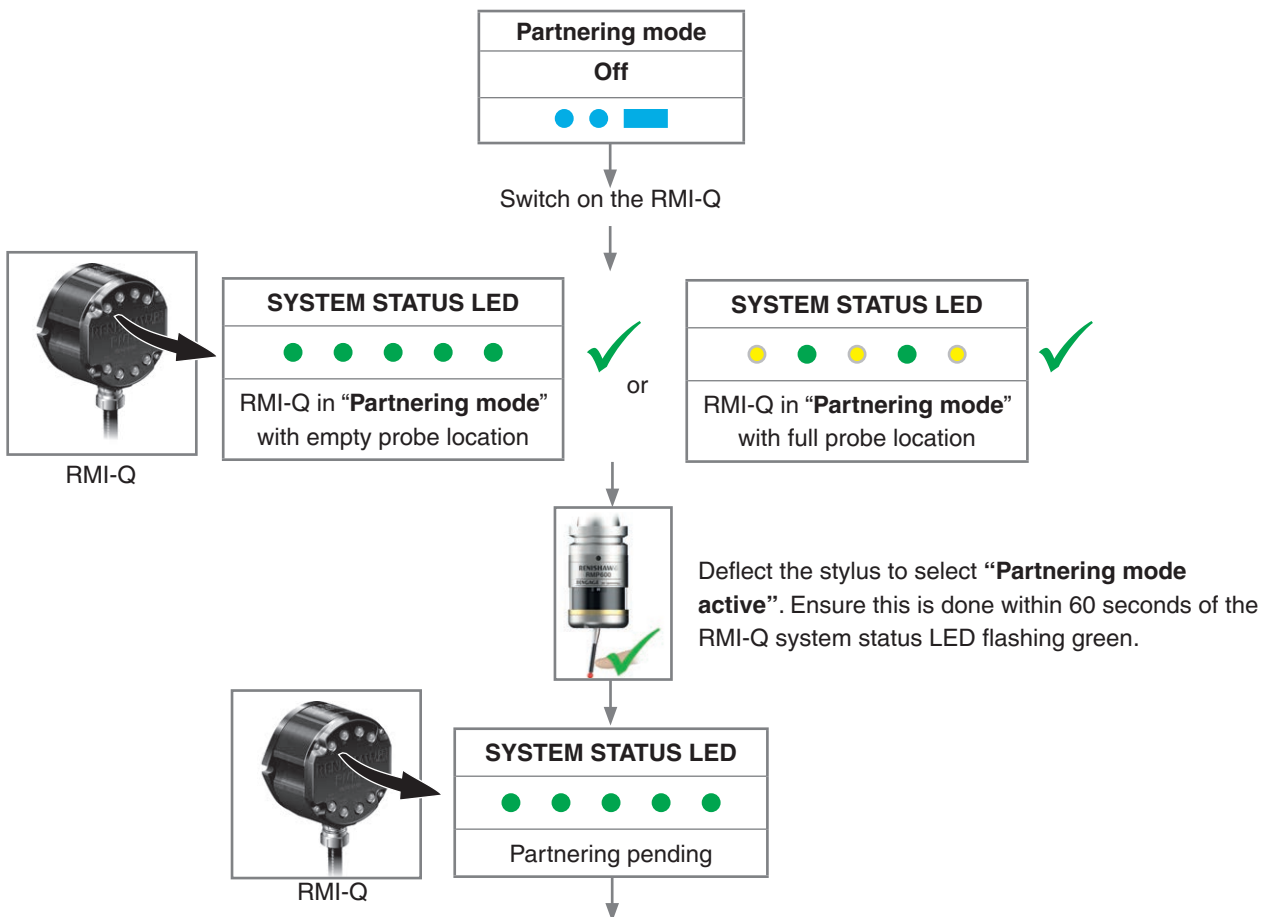

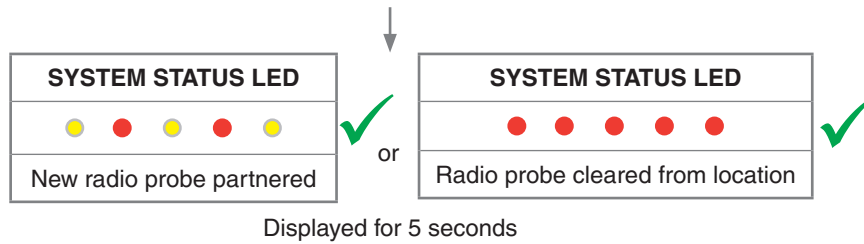

NOTE: Refer to the *RMI-Q radio machine interface* installation guide (Renishaw part no. H-5687-8504) when partnering up to four radio probes.

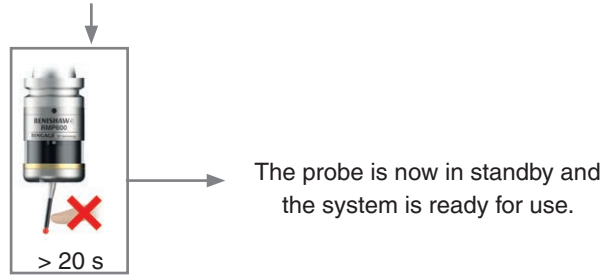

RMP600 – RMI-QE partnership

System set-up is achieved by using Trigger Logic™ and powering on the RMI-QE. Alternatively, partnering to an RMI-QE can be achieved by using ReniKey; a Renishaw machine macro cycle which does not require the RMI-QE to be power cycled.

Partnering is required during initial system set-up. Further partnering will be required if either the RMP600 or RMI-QE is changed.

Partnering will not be lost by reconfiguring the probe settings or changing the batteries. Partnering can take place anywhere within the operating envelope.

An RMP600 that is partnered with the RMI-QE but then used with another system will need to be repartnered before being used again with the RMI-QE.

See **page 4-5** “Probe partnering function” for further information on how to reach “**Partnering mode**”.

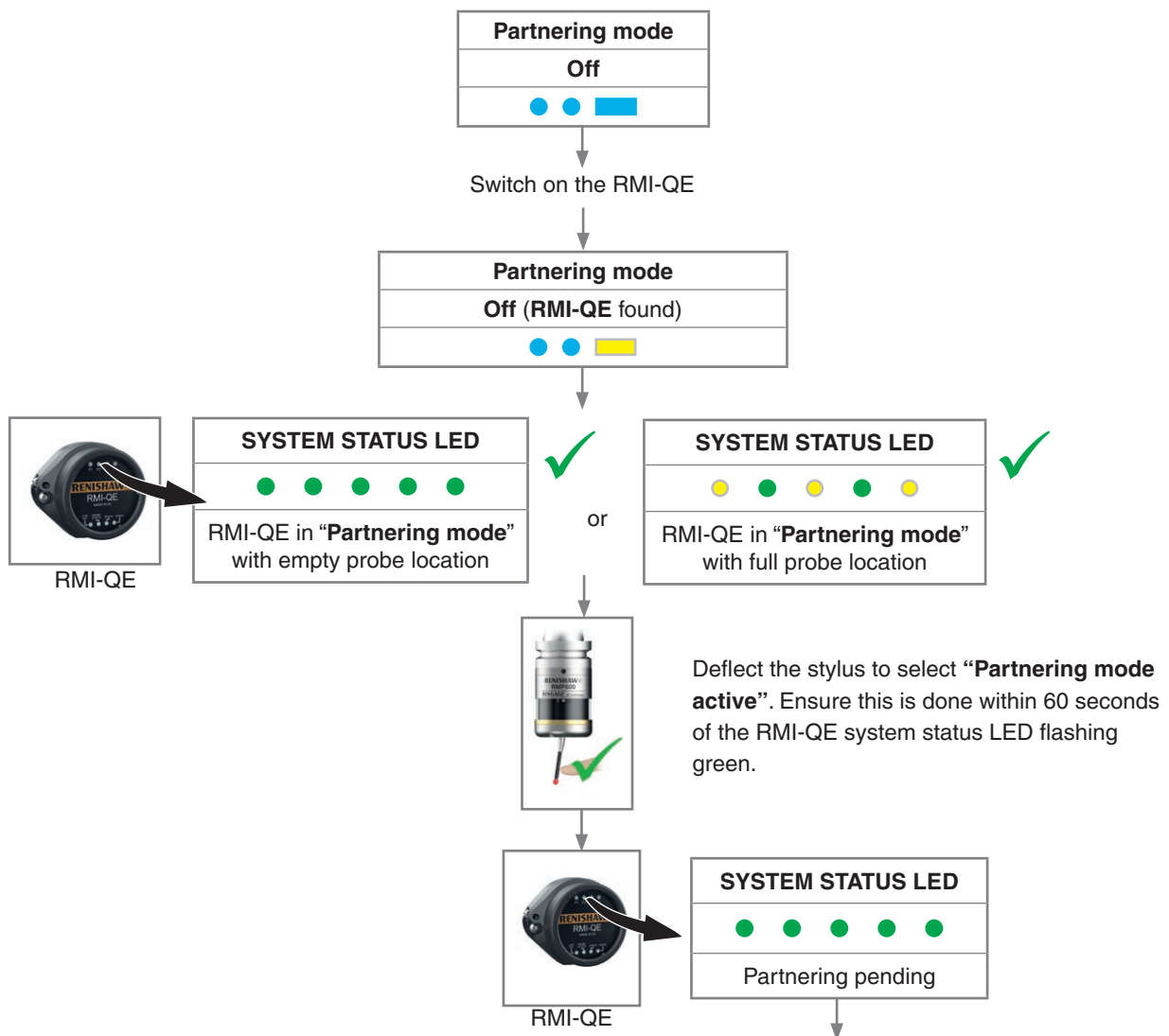

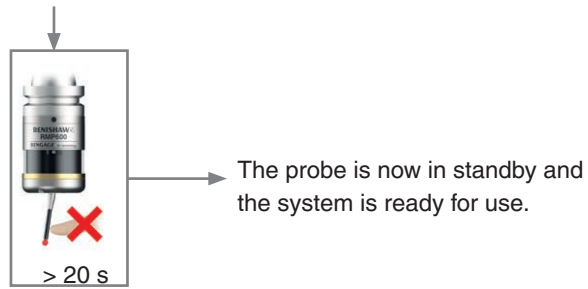
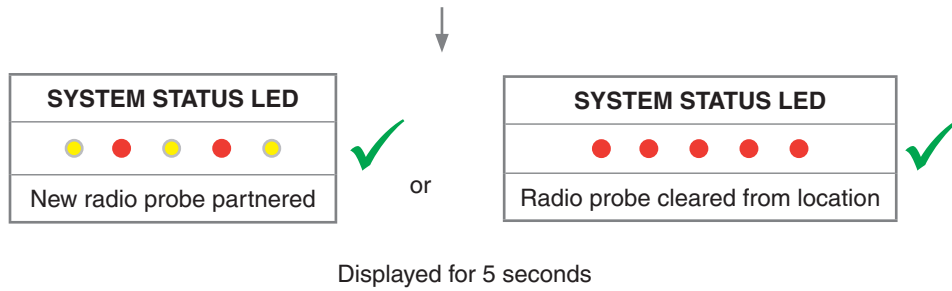

NOTE: Refer to the *RMI-QE radio machine interface* installation guide (Renishaw part no. H-6551-8520) when partnering up to four radio probes.

Changing the probe settings when partnered to an RMI-Q

Probe settings can be changed using Trigger Logic. Insert the batteries or, if they have already been installed, remove them for 5 seconds and then refit them.

Following the LED check, immediately deflect the stylus and hold it deflected until eight red flashes have been observed (if the battery power is low, each red flash will be followed by a blue flash).

Keep the stylus deflected until the “**Switch-on method**” setting is displayed, then release it.

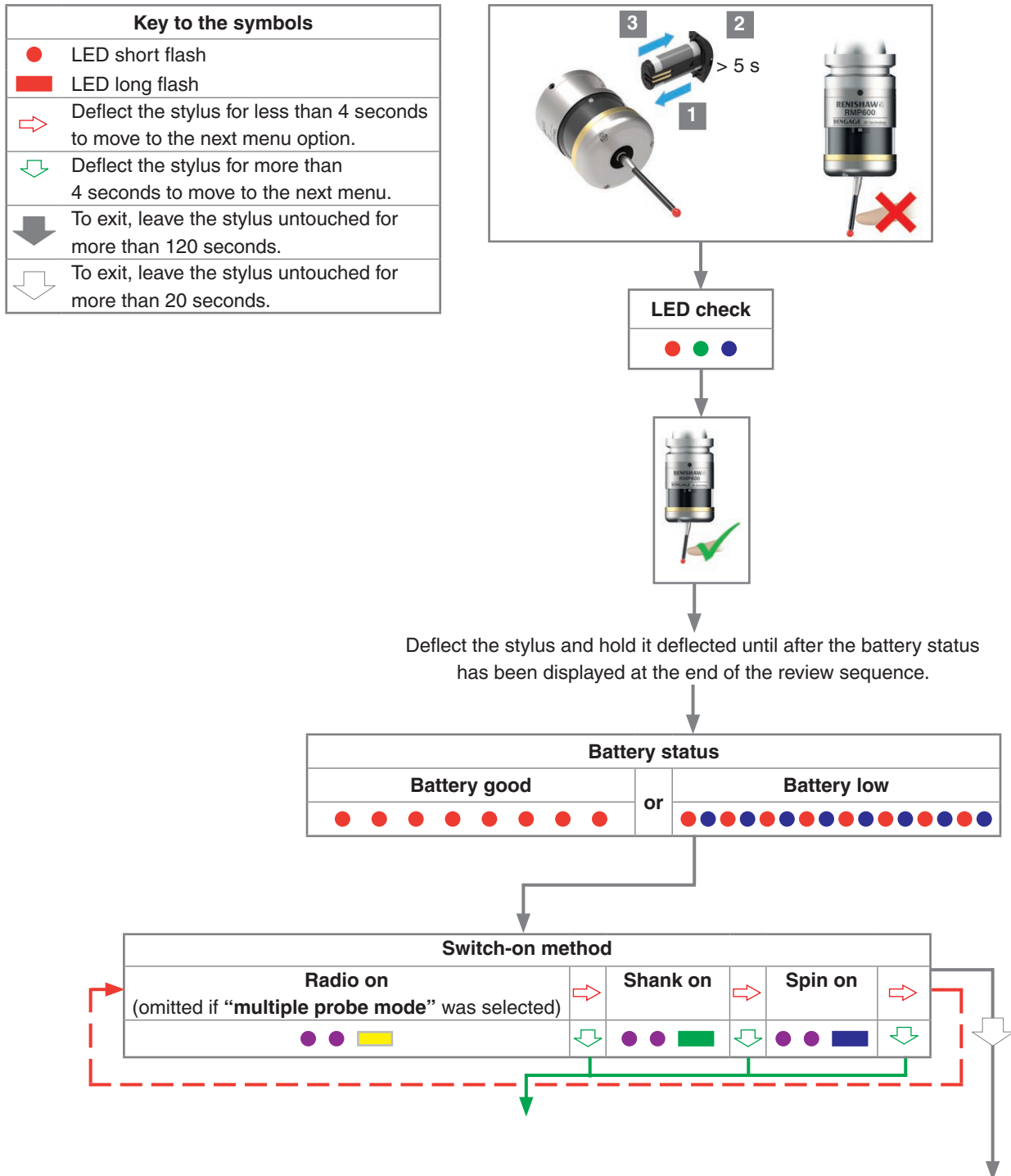

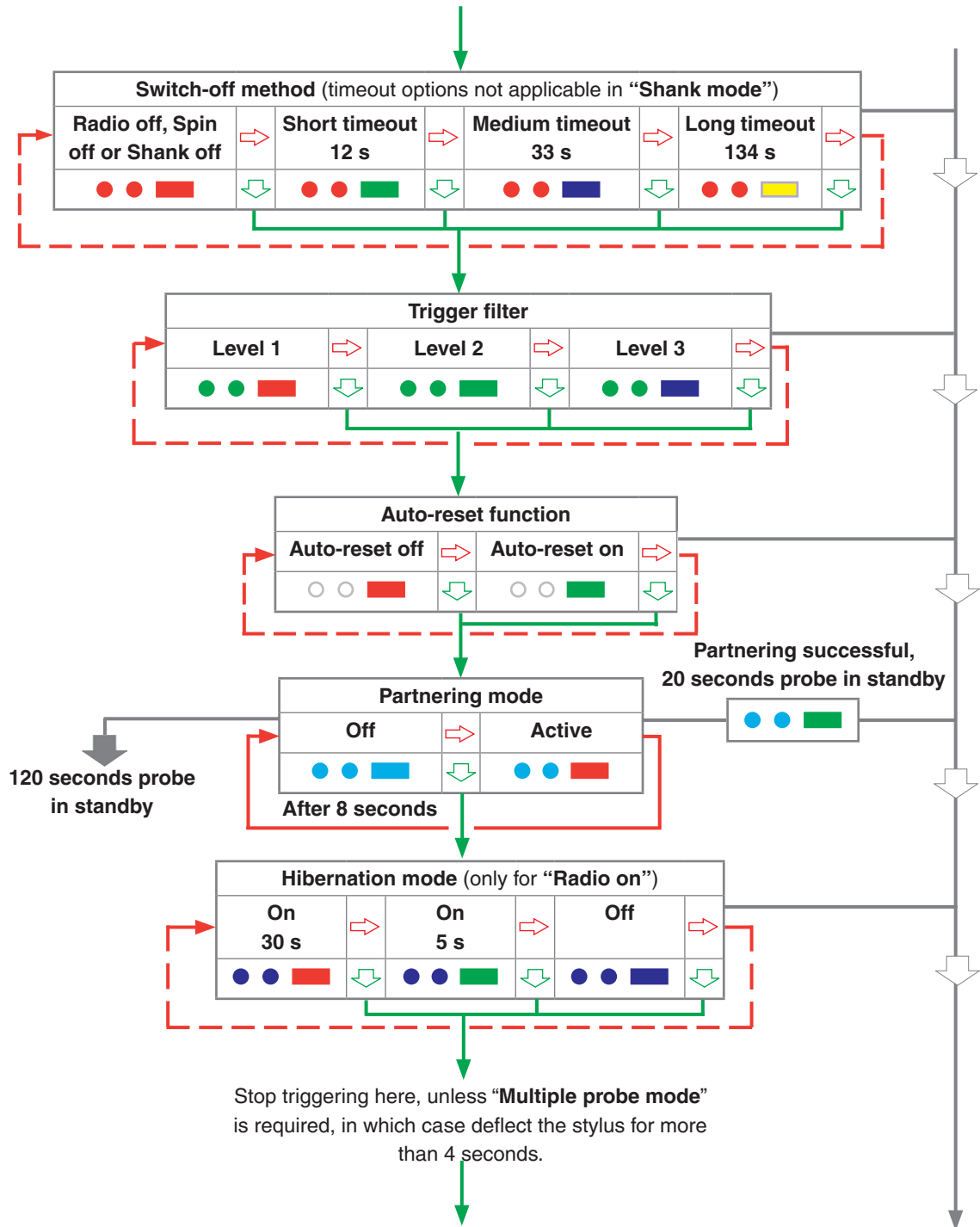

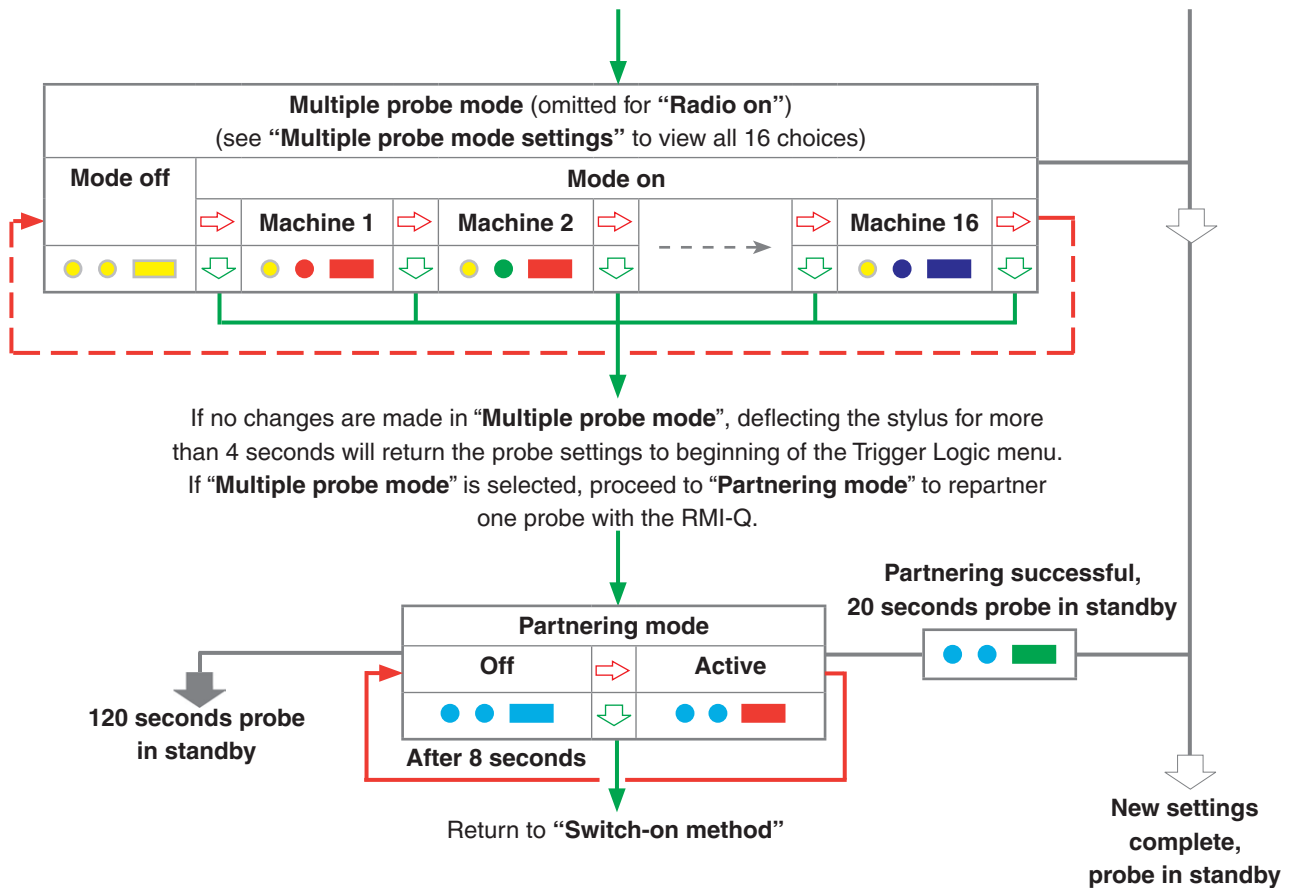

NOTES:

If using “Multiple probe mode”, refer to the *RMI-Q radio machine interface* installation guide (Renishaw part no. H-5687-8504).

Further probes used require the same “Multiple probe mode” setting, but do not need to be partnered with the RMI-Q.

To partner an RMP600 with an RMI-Q, see **page 4.7**, “RMP600 – RMI-Q partnership”, for further information. Once partnering has been successful, the RMP600 will display “Partnering successful” and go into standby after 20 seconds.

Changing the probe settings when partnered to an RMI-QE

Probe settings can be changed using Trigger Logic. Insert the batteries or, if they have already been installed, remove them for 5 seconds and then refit them.

Following the LED check, immediately deflect the stylus and hold it deflected until eight red flashes have been observed (if the battery power is low, each red flash will be followed by a blue flash).

Keep the stylus deflected until the “**Switch-on method**” setting is displayed, then release it.

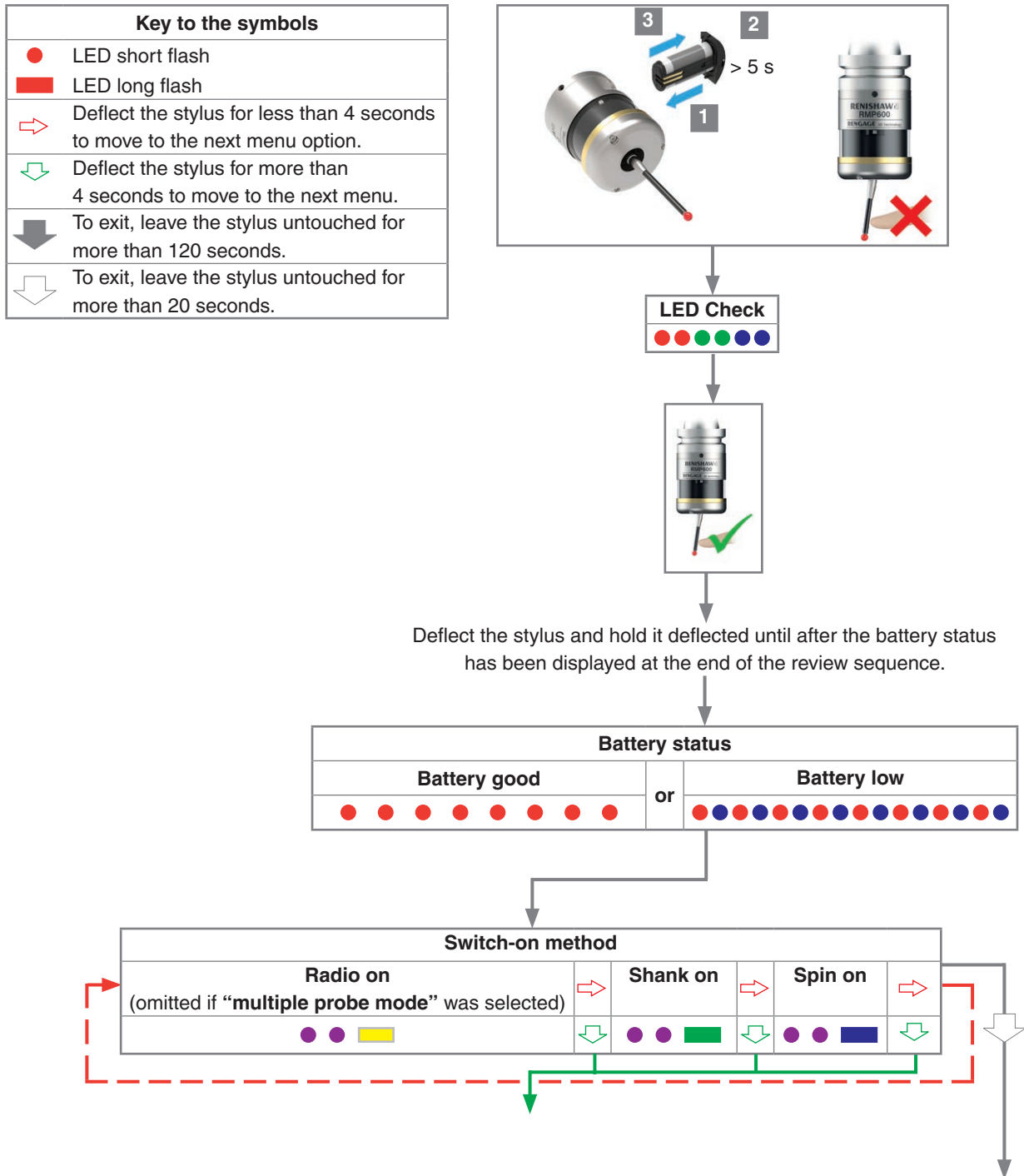

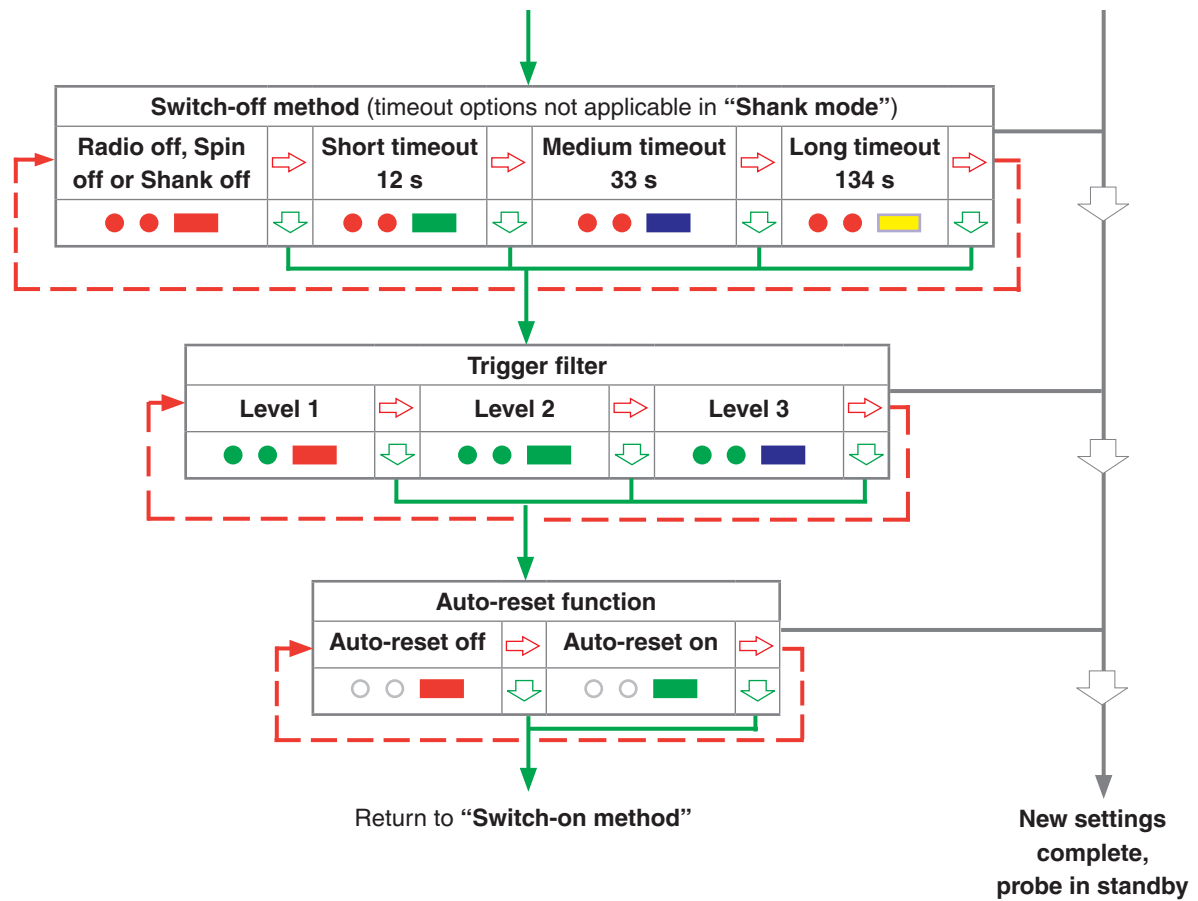

NOTE: To partner an RMP600 with an RMI-QE, see [page 4.5](#) "Probe partnering function" for further information on how to reach "Partnering mode".

Master reset function

The RMP600 features a master reset function to assist users who have mistakenly changed the probe settings into an unintended state.

The application of the master reset function will clear all current probe settings and return the probe to default settings.

The default settings are as follows:

- Radio switch-on
- Radio switch-off
- Trigger filter: Level 2
- Auto-reset on
- Hibernation mode on 30 s
- Multiple probe mode off

The default settings may not be representative of the required probe settings. Further configuration of the RMP600 may subsequently be necessary to achieve the required probe settings.

To reset the probe

1. Insert the batteries or, if they have already been installed, remove them for 5 seconds and then refit them.
2. Following the LED check, immediately deflect the stylus and hold it deflected until eight red flashes have been observed (if the battery power is low, each red flash will be followed by a blue flash).
3. Keep the stylus deflected until the “**Switch-off method**” setting (or first Trigger Logic menu) is displayed, then release it.
4. Hold the stylus deflected for 20 seconds. After this the status LEDs will proceed to flash yellow eight times. A confirmation for master reset is required, if nothing is done the probe will timeout.
5. To confirm that a master reset is required, release the stylus and then hold the stylus deflected again until the eight yellow flash sequence has ended. This action will clear all probe settings and return the probe to default settings. Following an LED check the RMP600 will go back into Trigger Logic and will display “**Switch-off method**”.
6. Further configuration using Trigger Logic may be necessary to achieve the required probe settings.

1.

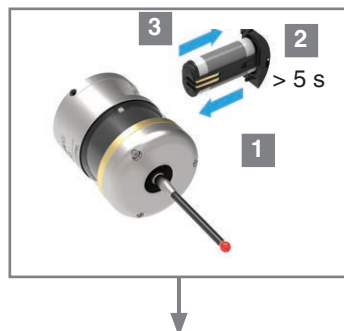

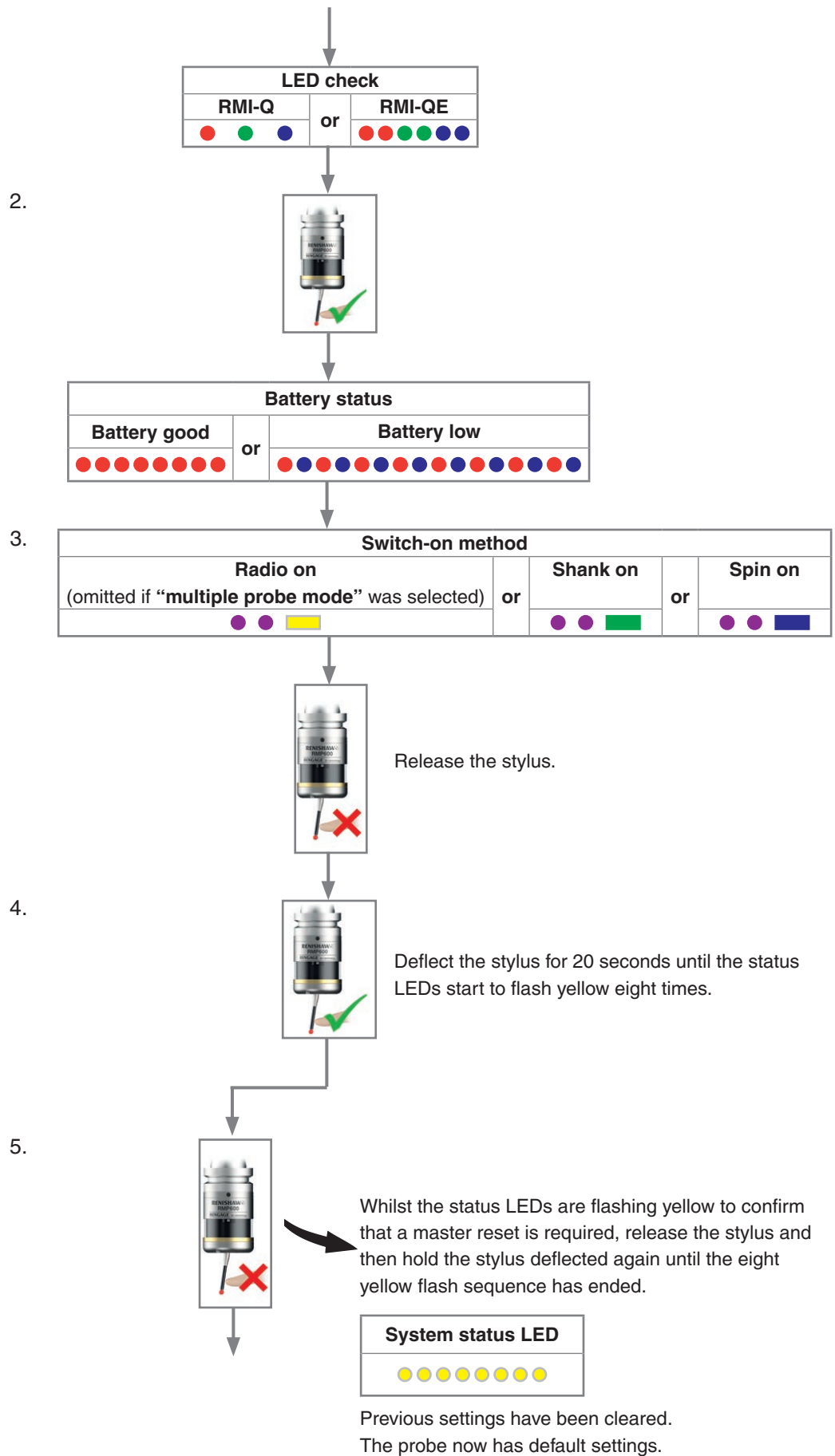

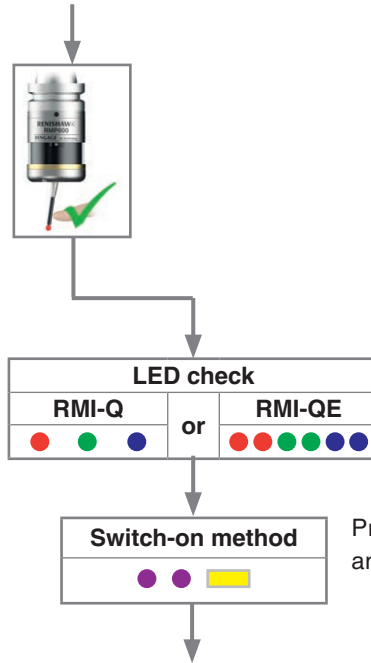

Probe is now back in the Trigger Logic menu and will display "Switch-off method".

6. Configure probe settings as required using Trigger Logic.

NOTE: The RMP600 will continue to be partnered with either the RMI-Q or RMI-QE following the activation of the master reset function.

Operating mode

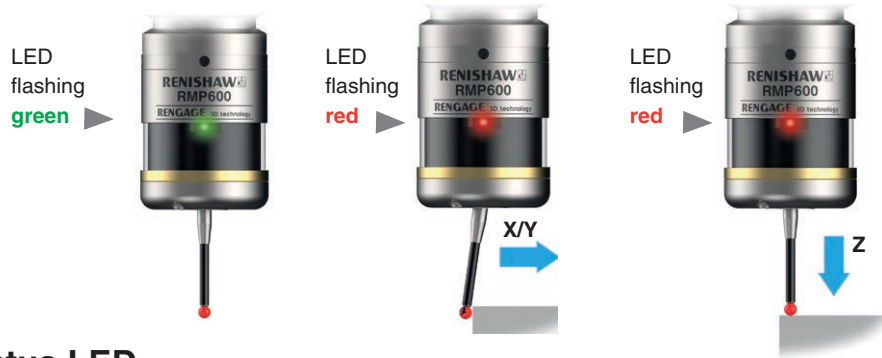

Probe status LED

LED colour	Probe status	Graphic hint
Flashing green	Probe seated in operating mode	● ● ●
Flashing red	Probe triggered in operating mode	● ● ●
Flashing green and blue	Probe seated in operating mode – low battery	● ● ● ● ● ●
Flashing red and blue	Probe triggered in operating mode – low battery	● ● ● ● ● ●
Constant red	Battery dead	■
Flashing red or Flashing red and green or Sequence when batteries are inserted	Unsuitable battery	● ● ● ● ● ● ● ● ● ● ● ● ● ● ● ● ● ●
Constant blue	Probe damaged beyond use	■

NOTE: Due to the nature of lithium-thionyl chloride batteries, if a “low battery” LED warning is ignored, it is possible for the following sequence of events to occur:

1. When the probe is active, the batteries discharge until battery power becomes too low for the probe to operate correctly.
2. The probe stops functioning, then reactivates as the batteries recover sufficiently to provide the probe with power.
3. The probe begins to run through the LED review sequence (see **page 4-2**, “Reviewing the probe settings”, for further information).
4. Again, the batteries discharge and the probe ceases to function.
5. Again, the batteries recover sufficiently to provide the probe with power, and the sequence repeats itself.

Maintenance

Maintenance

You may undertake the maintenance routines described in these instructions.

Further dismantling and repair of Renishaw equipment is a highly specialised operation, which must be carried out at an authorised Renishaw Service Centre.

Equipment requiring repair, overhaul or attention under warranty should be returned to your supplier.

Cleaning the probe

Wipe the window of the probe with a clean cloth to remove machining residue. This should be done on a regular basis to maintain optimum transmission.

CAUTION: The RMP600 has a glass window. Handle with care if broken to avoid injury.



Changing the batteries

CAUTIONS:

Do not leave dead batteries in the probe.

When changing batteries, do not allow coolant or debris to enter the battery compartment.

When changing batteries, check that the battery polarity is correct.

Take care to avoid damaging the battery cassette gasket.

Only use specified batteries.

Dispose of dead batteries in accordance with local regulations. Never dispose of batteries in a fire.



NOTES:

After removing the old batteries, wait more than 5 seconds before inserting the new batteries.

Do not mix new and used batteries or battery types, as this will result in reduced life and damage to the batteries.

Always ensure that the cassette gasket and mating surfaces are clean and free from dirt before reassembly.

If dead batteries are inadvertently inserted, the LED will remain a constant red.

Battery types			
Alkaline × 2	Lithium-thionyl chloride × 2		Nickel Cadmium / Nickel Metal Hydride × 2
AA 1.5 V ✓	AA 3.6 V	Saft: LS 14500 Tadiran: SL-760/S, TL-5903/S, TL-2100/S Xeno: XL-060F	AA 1.2 V ✓

NOTE: Lithium-thionyl chloride batteries are available from other manufacturers. However, these are untested by Renishaw so correct operation of the probe cannot be guaranteed.



Diaphragm replacement

RMP600 diaphragms

The probe mechanism is protected from coolant and debris by two diaphragms. These provide adequate protection under normal working conditions.

You should periodically check the outer diaphragm for signs of damage. If this is evident, replace the outer diaphragm.

Do not remove the inner diaphragm. If it is damaged, return the probe to your supplier for repair.

Outer diaphragm inspection

1. Remove the stylus.
2. Undo the three M3 front cover screws and remove the front cover.
3. Inspect the outer diaphragm for damage.
4. To remove the outer diaphragm, grip by the outer edge and pull off.

Inner diaphragm inspection

Inspect the inner diaphragm for damage. If it is damaged, return the probe to your supplier.

CAUTION: Do not remove the inner diaphragm. This will invalidate your warranty.

Outer diaphragm replacement

5. Fit the new diaphragm over the centre.
6. Locate the outer edge of the diaphragm to rest on the outer edge of the inner diaphragm.
7. Refit the front cover and M3 screws.
8. Refit the stylus and recalibrate the probe.



This page is intentionally left blank.

Fault-finding

Symptom	Cause	Action
The probe fails to power up (no LEDs illuminated or fails to indicate current probe settings).	Dead batteries.	Change batteries.
	Unsuitable batteries.	Fit suitable batteries.
	Batteries inserted incorrectly.	Check battery insertion/polarity.
	Batteries removed for too short a time and probe has not reset.	Remove batteries for a minimum of 5 seconds.
	Poor connection between battery cassette mating surfaces and contacts.	Remove any dirt and clean the contacts before reassembly.
The probe fails to switch on.	Dead batteries.	Change batteries.
	Batteries inserted incorrectly.	Check battery insertion/polarity.
	Probe out of range.	Check position of RMI-Q or RMI-QE; for more information, see page 3-2 "Performance envelope".
	No RMI-Q or RMI-QE "start/stop" signal ("radio on" method only).	Check RMI-Q or RMI-QE for green start LED.
	Incorrect spin speed ("spin on" method only).	Check spin speed and duration.
	Malfunctioning shank switch ("shank switch mode" only).	Check switch operation.
	Incorrect "switch on" method configured.	Check configuration and alter as required.
	Incorrect multiple probe mode setting configured (RMI-Q only).	Check configuration and alter as required.
	RMP600 in hibernation mode (RMI-Q and "radio on" method only).	Ensure probe is in range and wait up to 30 seconds, then resend switch-on signal. Check position of RMI-Q; For more information, see page 3-2 "Performance envelope".
Spin on is within 1 second of spin off.	Check for 1 second dwell following spin off.	

Symptom	Cause	Action
The machine stops unexpectedly during a probing cycle.	Radio link failure/RMP600 out of range.	Check interface / receiver and remove obstruction.
	RMI-Q or RMI-QE receiver / machine fault.	Refer to receiver / machine installation guide.
	Dead batteries.	Change batteries.
	Excessive machine vibration causing false probe trigger.	Change trigger filter setting.
	Probe unable to find target surface.	Check that part is correctly positioned and that stylus has not broken.
	Stylus not given sufficient time to settle from a rapid deceleration.	Add a short dwell before the probing move (length of dwell will depend on stylus length and rate of deceleration).
The probe crashes.	Workpiece obstructing probe path.	Review probing software.
	Probe length offset missing.	Review probing software.
	In cases where there is more than one probe on a machine, incorrect probe activated.	Review interface wiring or part program.
The probe permanently triggered.	Probe orientation has changed, for example from horizontal to vertical.	Select probe " Auto-reset " function.
	New stylus has been fitted.	Turn probe off and on again.
	Probe was switched on when stylus was deflected.	Turn probe off and on again. Ensure stylus is seated during switch on.
	Probe has not settled before a trigger move occurs following a rotation or rapid move (" Auto-reset " mode only).	Turn probe off and on again, and increase the dwell from 0.2 to 0.5 second dwell before probing move.
	Probe has collided with an object during a rotation or rapid move (" Auto-reset " mode only).	Turn probe off and on again.

Symptom	Cause	Action
Poor probe repeatability and/or accuracy.	Debris on part or stylus.	Clean part and stylus.
	Poor tool change repeatability.	Redatum probe after each tool change.
	Loose probe mounting on shank or loose stylus.	Check and tighten as appropriate.
	Excessive machine vibration.	Change trigger filter setting. Eliminate vibrations.
	Calibration out of date and/or incorrect offsets.	Review probing software.
	Calibration and probing speeds not the same.	Review probing software and make speeds the same.
	Calibration feature has moved.	Correct the position.
	Measurement occurs as stylus leaves surface.	Review probing software.
	Measurement occurs within the machine's acceleration and deceleration zone.	Review probing software and probe filter settings.
	Probing speed too high or too low.	Perform simple repeatability trials at various speeds.
	Temperature variation causes machine and workpiece movement.	Minimise temperature changes.
RMP600 status LEDs do not correspond to RMI-Q or RMI-QE status LEDs.	Machine tool faulty.	Perform health checks on machine tool.
	Radio link failure – RMP600 out of RMI-Q or RMI-QE range.	Check position of RMI-Q or RMI-QE; for more information, see page 3-2 “Performance envelope”.
	RMP600 has been enclosed/shielded by metal.	Review installation.
	RMP600 and RMI-Q or RMI-QE are not partnered.	Partner RMP600 and RMI-Q or RMI-QE; for more information, see page 4-8 “RMP600 – RMI-Q partnership” or page 4-10 “RMP600 – RMI-QE partnership”.

Symptom	Cause	Action
RMI-Q or RMI-QE error LED lit during probing cycle.	Probe not switched on or probe timed out.	Change setting. Review switch-off method.
	Probe out of range.	Check position of RMI-Q or RMI-QE; for more information, see page 3-2 "Performance envelope".
	Dead batteries.	Change batteries.
	RMP600 and RMI-Q or RMI-QE are not partnered.	Partner RMP600 and RMI-Q or RMI-QE; for more information, see page 4-8 "RMP600 – RMI-Q partnership" or page 4-10 "RMP600 – RMI-QE partnership".
	Probe selection error.	Verify that one radio probe is working and is correctly selected on the RMI-Q or RMI-QE.
	"Fast" second turn-on error.	Change the RMI-Q or RMI-QE turn-on time to "standard".
RMI-Q or RMI-QE low battery LED lit.	Low batteries.	Change batteries soon.
Reduced range.	Local radio interference.	Identify and remove.
The probe fails to switch off.	Incorrect " switch-off " method configured.	Check configuration and alter as required.
	No RMI-Q or RMI-QE "start/stop" signal (" radio on " method only).	Check RMI-Q or RMI-QE for green start LED.
	Probe in timeout mode and placed in tool magazine and being triggered by movement.	Use shorter timeout setting or use different switch-off method.
	Incorrect spin speed (spin switch on only).	Check spin speed.
	Spin off is within 1 second of a spin on.	Check for a 1 second dwell following a spin on.
The probe goes into Trigger Logic™ configuration mode and cannot be reset.	Probe was triggered when batteries were inserted.	Do not touch the stylus or stylus mounting face during battery insertion.
The probe status LED shows a constant blue	Probe damaged beyond use.	Return the probe to your nearest Renishaw supplier for repair/ replacement.

Parts list

Type	Part number	Description
RMP600 (QE)	A-6554-0001	RMP600 (QE) probe with batteries, tools and support card (factory-set to radio on / radio off).
Batteries	P-BT03-0005	AA battery – alkaline – supplied as standard with probe (pack of two).
Batteries	P-BT03-0008	AA battery – lithium-thionyl chloride (pack of two).
Stylus	A-5003-7306	50 mm long carbon fibre stylus with Ø6 mm ball.
Stylus	A-5003-6510	100 mm long carbon fibre stylus with Ø6 mm ball.
Stylus	A-5003-6511	150 mm long carbon fibre stylus with Ø6 mm ball.
Stylus	A-5003-6512	200 mm long carbon fibre stylus with Ø6 mm ball.
Styli tool	M-5000-3707	Tool for tightening/releasing styli.
Tools	A-4038-0304	Probe tool kit comprising Ø1.98 mm stylus tool(× 1), 2 mm A/F hexagon key (× 1), 2.5 mm A/F hexagon key (× 2), 4 mm A/F hexagon key (× 1) and shank grub screw (× 2).
Battery cassette	A-4038-0300	RMP600 battery cassette assembly.
Battery gasket	A-4038-0301	RMP600 battery cap gasket kit.
Diaphragm kit	A-5312-0302	RMP600 diaphragm kit.
Bobbin kit	A-4038-0303	Bobbin for shank switch (supplied with shank).
RMI-Q	A-5687-0049	RMI-Q (side exit) with 8 m (26.2 ft) cable, tools and support card.
RMI-Q	A-5687-0050	RMI-Q (side exit) with 15 m (49.2 ft) cable, tools and support card.
RMI-QE	A-6551-0049	RMI-QE with 8 m (26.2 ft) cable, tools and support card.
RMI-QE	A-6551-0050	RMI-QE with 15 m (49.2 ft) cable, tools and support card.
RMI-QE	A-6551-0051	RMI-QE with 30 m (98.4 ft) 17-way cable with flying lead, tools and support card.
RMI-Q mounting bracket	A-2033-0830	RMI-Q mounting bracket with fixing screws, washers and nuts.
RMI-QE mounting bracket	A-6551-0120	RMI-QE mounting bracket with fixing screws, washers and nuts.
Publications. These can be downloaded from our website at www.renishaw.com		
RMI-Q	H-5687-8504	Installation guide: for set-up of the RMI-Q.
RMI-QE	H-6551-8520	Installation guide: for set-up of the RMI-QE.
Styli	H-1000-3200	Technical specifications: <i>Styli and accessories</i> – or visit our Online store at www.renishaw.com/shop .
Probe software	H-2000-2298	Data sheet: <i>Probe software for machine tools – programs and features</i> .
Taper shanks	H-2000-2011	Data sheet: <i>Taper shanks for machine tool probes</i> .

www.renishaw.com/rmp600



#renishaw

 +44 (0) 1453 524524

 uk@renishaw.com

© 2022–2023 Renishaw plc. All rights reserved. This document may not be copied or reproduced in whole or in part, or transferred to any other media or language by any means, without the prior written permission of Renishaw.

RENISHAW® and the probe symbol are registered trade marks of Renishaw plc. Renishaw product names, designations and the mark 'apply innovation' are trade marks of Renishaw plc or its subsidiaries. Other brand, product or company names are trade marks of their respective owners.

WHILE CONSIDERABLE EFFORT WAS MADE TO VERIFY THE ACCURACY OF THIS DOCUMENT AT PUBLICATION, ALL WARRANTIES, CONDITIONS, REPRESENTATIONS AND LIABILITY, HOWSOEVER ARISING, ARE EXCLUDED TO THE EXTENT PERMITTED BY LAW. RENISHAW RESERVES THE RIGHT TO MAKE CHANGES TO THIS DOCUMENT AND TO THE EQUIPMENT, AND/OR SOFTWARE AND THE SPECIFICATION DESCRIBED HEREIN WITHOUT OBLIGATION TO PROVIDE NOTICE OF SUCH CHANGES.

Renishaw plc. Registered in England and Wales. Company no: 1106260. Registered office: New Mills, Wotton-under-Edge, Glos, GL12 8JR, UK.

Part no.: H-6554-8520-02-A

Issued: 09.2023