









Feature tables

Feature tables can be created either manually or automatically. Automatically created feature tables will display all feature tolerances in order of output. If a tolerance has a GD&T tolerance frame, then this will be shown in the feature table so that it matches with the part drawing.

Tolerance	Type	Min	Max	Nominal	Actual	Deviation	Error	Graphic
CIR001								
Circularity	 0.1000				0.1817	0.1817	0.0817	
Diameter	Diameter	-0.1000	0.1000	88.0000	87.9805	-0.0195	0.0000	
CIR002								
Circularity	 0.1000				0.1670	0.1670	0.0670	
Diameter	Diameter	-0.1000	0.1000	25.0000	24.9944	-0.0056	0.0000	
CYL001								
Cylindricity	 0.1000				0.1569	0.1569	0.0569	
Diameter	Diameter	-0.1000	0.1000	80.0000	80.0376	0.0376	0.0000	

Deviation callouts

- Individual point deviations can be displayed
- Also available for Profile tolerances
- “Free Pick” and “Equally Spaced” options

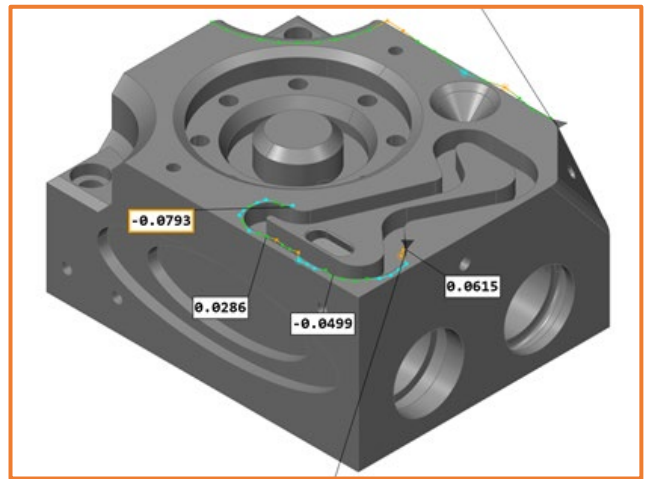

Traditional off-CAD plots

Plots are also available in the traditional off-CAD manner. These can be used if there are multiple plots for the same feature or if different views of the same plot are required.

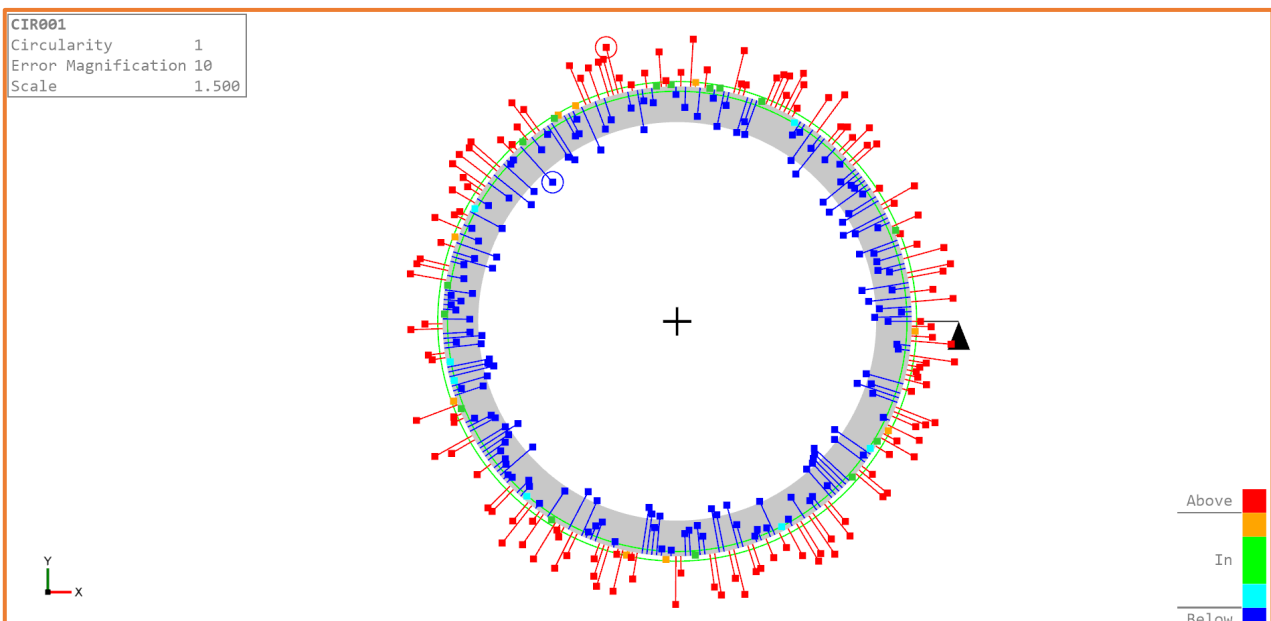

If you have any questions or comments on this bulletin, please contact cmm.support@renishaw.com

Samples

Once the software is installed, sample data for demonstrations can be found at the following location: C:\ProgramData\Renishaw\MODUS CHaRT\v1\Samples

Licences

MODUS CHART is available free of charge as an add-on to a MODUS 1.11 licence. The CHART licence must still be ordered and then added to the existing dongle (orange dongle only).

Standalone versions of MODUS CHART can be purchased either on a dongle or as a PC based licence known as "Trusted Storage".

Software compatibility

CHART requires QIF files to produce reports. MODUS 1.11 is required to produce QIF files.

New part numbers

For details on pricing, please contact your local Renishaw supplier.

MODUS CHART	Part number
Customer licences – permanent	
MODUS CHART (add-on to existing MODUS 1.11 orange dongle)	CS-SOF-SW-01-1421
MODUS CHART (orange dongle and licence) – standalone version	A-5871-3001-KEY
MODUS CHART (Trusted Storage licence) – standalone version	CS-SOF-SW-01-1516
Maintenance	
MODUS CHART – dongle – one year maintenance	CS-SOF-MAINT-01-1423
MODUS CHART – dongle – one month maintenance	CS-SOF-MAINT-01-1427
MODUS CHART – Trusted Storage – one year maintenance	CS-SOF-MAINT-01-1560
MODUS CHART – Trusted Storage – one month maintenance	CS-SOF-MAINT-01-1564
Evaluation licences – one month	
MODUS CHART - evaluation – (Trusted Storage licence)	CS-SOF-SW-01-1517