

RLI20-P laser interface (Panasonic)



© 2012-2015 Renishaw plc. All rights reserved.

This document may not be copied or reproduced in whole or in part, or transferred to any other media or language, by any means, without the prior written permission of Renishaw.

The publication of material within this document does not imply freedom from the patent rights of Renishaw plc.

Disclaimer

RENISHAW HAS MADE CONSIDERABLE EFFORTS TO ENSURE THE CONTENT OF THIS DOCUMENT IS CORRECT AT THE DATE OF PUBLICATION BUT MAKES NO WARRANTIES OR REPRESENTATIONS REGARDING THE CONTENT. RENISHAW EXCLUDES LIABILITY, HOWSOEVER ARISING, FOR ANY INACCURACIES IN THIS DOCUMENT.

Trademarks

RENISHAW and the probe symbol used in the RENISHAW logo are registered trade marks of Renishaw plc in the United Kingdom and other countries. **apply innovation** and names and designations of other Renishaw products and technologies are trade marks of Renishaw plc or its subsidiaries.

All other brand names and product names used in this document are trade names, trade marks, or registered trade marks of their respective owners.

Care of equipment

The RLI20 laser interface contains precision electronic components. Avoid exposure to moisture. Remove power before connecting, disconnecting or handling.

Changes to Renishaw products

Renishaw plc reserves the right to improve, change or modify its products and documentation without incurring any obligation to make changes to Renishaw equipment previously sold or distributed.

Warranty

Renishaw plc warrants its equipment provided that it is installed exactly as defined in associated Renishaw documentation.

Renishaw part no: M-9926-0005-02-B

Issued: 09 2015

Safety

It is the responsibility of the manufacturer and/or encoder system installation authority to ensure that, in safety critical applications of the RLI20 laser interface, any form of signal deviation from the limits of the receiving electronics, howsoever caused, shall not cause the machine to become unsafe. It is also their responsibility to ensure that the end user is made aware of any hazards involved in the operation of their machine, including those mentioned in Renishaw product documentation, and to ensure that adequate guards and safety interlocks are provided.

When using the RLI20 as part of a positioning system on machines, beware of pinch and/or crush hazards that can be created, depending on how and where the equipment is installed.

Further information on safety is contained in Appendix B.

The RLI20 has been designed for use with an RLE or HS20 laser encoder only. Its use is not supported with other encoder systems.

FCC notice

This device complies with part 15 of the FCC Rules. Operation is subject to the following two conditions: (1) This device may not cause harmful interference and (2) this device must accept any interference received, including interference that may cause undesired operation.

This equipment has been tested and found to comply with the limits for a Class A digital device, pursuant to part 15 of the FCC rules. These limits are designed to provide reasonable protection against harmful interference when the equipment is operated in a commercial environment. This equipment generates, uses, and can radiate radio frequency energy and, if not installed and used in accordance with the instruction manual, may cause harmful interference to radio communications. Operation of this equipment in a residential area is likely to cause harmful interference in which case the user will be required to correct the interference at his own expense.

The user is cautioned that any changes or modifications not expressly approved by Renishaw plc or authorised representative could void the user's authority to operate the equipment.

EC compliance



Renishaw plc declares that the RLI20 interface complies with the applicable directives, standards and regulations. A copy of the full EC Declaration of Conformity is available at the following address:

www.renishaw.com/RLECE

WEEE

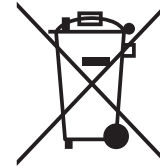

The use of this symbol on Renishaw products and/or accompanying documentation indicates that the product should not be mixed with general household waste upon disposal. It is the responsibility of the end user to dispose of this product at a designated collection point for waste electrical and electronic equipment (WEEE) to enable reuse or recycling. Correct disposal of this product will help to save valuable resources and prevent potential negative effects on the environment.

For more information, please contact your local waste disposal service or Renishaw distributor.

Contents

1	System overview	2
1.1	Part numbers	2
2	Installation	3
2.1	Analogue quadrature interface.....	3
2.2	Serial interface	5
2.3	Error output	6
2.4	Power	6
2.5	Mechanical installation.....	7
3	Configuration	8
3.1	RLE set-up – dip switches	8
3.2	Position	9
3.3	Error output	10
3.4	LED indicators.....	10
	Appendix A – Specification	11
	Appendix B – Safety information	12

1 System overview

The RLI20 converts 1 Vpp analogue quadrature signals from an RLE laser interferometer encoder system into a position reading, which is available over a serial bus.

The RLI20-P is specifically programmed to be compatible with Panasonic motor controllers.

1.1 Part numbers

The following saleable part numbers are available:

A-9926-0200 - RLI20P laser interface (Panasonic)

The following accessories are available:

A-9926-0204 - RLI connector kit

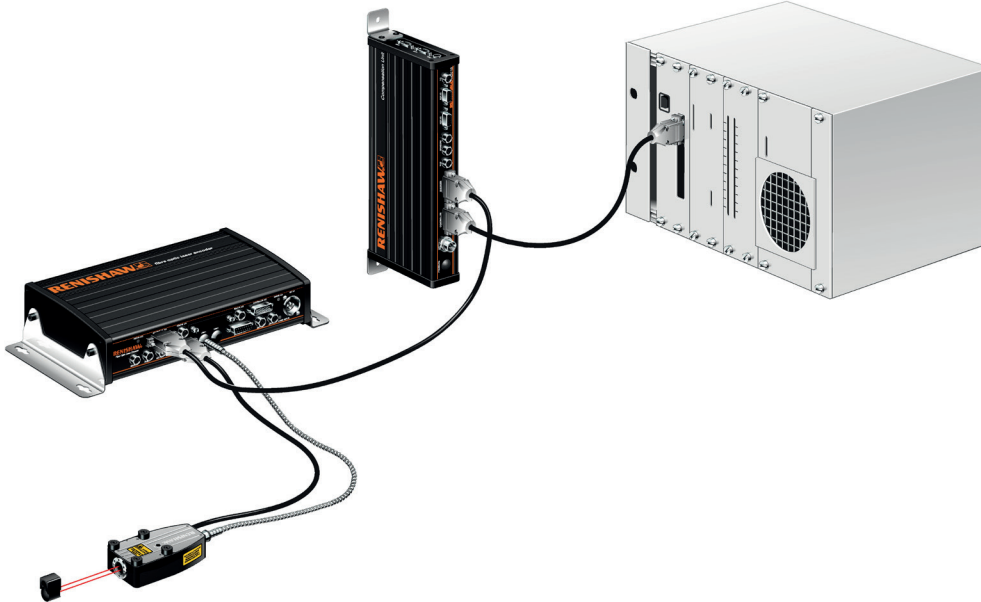

2 Installation

2.1 Analogue quadrature interface

The RLI20 accepts the nominal 1 V_{pp} analogue quadrature from the RLE or HS20. Signal termination is contained within the RLI20 itself. There is no need for any other termination to be used.

Cabling

The choice of cables for this application is very important. A cable with individually screened twisted pairs is recommended. An example of a suitable cable is the Belden 8164 cable. The maximum recommended cable length is 10 m.

The signals should be wired as shown in Table 1:

Table 1 – Signal wiring between RLE or HS20 and RLI20

Signal	Function
1st pair	Sine and /Sine
2nd pair	Cosine and /Cosine
3rd pair	Error and /Error
4th pair	Ref mark and /Ref mark
Individual screens	0 V (both ends)
Outer screen	Case/shell (both ends)

 **WARNING:** It is essential that the error line inputs are connected so that the RLI20 can determine if any errors have occurred in the RLE or HS20 system. If the analogue quadrature is incorrectly wired, the system may still work but may move distances and at speeds that are not expected and may move in the opposite direction to that expected. If a voltage exceeding ± 7 V is applied on any of the signals, damage to the unit can occur.

 **WARNING:** Care should be taken to ensure that individual signal wires do not short. It is advised that all joints are sleeved. If input signal wires short, the position output will be unreliable and the error signal may not work reliably.

Input connector pinout

The analogue quadrature input connector pinout is shown in Table 2. All pins are protected to ± 7 V. The connector on the RLI20 is a 15 way female D-type. Figure 1 shows the mating D-type connector.

Table 2 – Analogue quadrature input (15 way D-type male)

Pin number	Function
1	0 V
2	–
3	Error
4	Ref Mark
5	Sine
6	Cosine
7	–
8	–
9	–
10	/Error
11	/Ref Mark
12	/Sine
13	/Cosine
14	–
15	–
Shell	Chassis ground

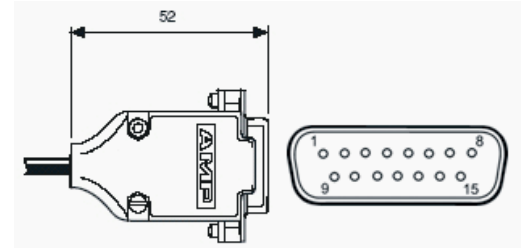

Figure 1 – Analogue quadrature input mating connector

2.2 Serial interface

The RLI20 outputs RS485 serial data at 2.5 Mbps.

Cabling

A screened twisted pair is recommended with SD+/SD- as one pair 0 V/5 V as second pair and outerscreen as chassis. The connection on the RLI20 is a 9 way male D-type, the mating connector is shown in Figure 2. Pinouts are show in Table 3. 5 V power from the controller is needed to detect when the controller is switched on or power cycled.

Table 3 – Serial interface pinout

Pin	Function
2	REQ+ / SD+
3	REQ- / SD-
4,5	5 V power from Panasonic controller
8,9	0 V
Shell	Chassis
1,6,7	Not connected

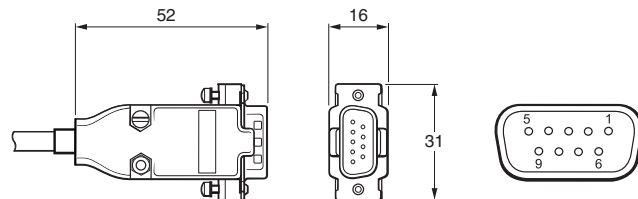

Figure 2 – 9 way female D-type connector

2.3 Error output

The RLI20 outputs on RS422 compatible error signal.

Cabling

A screened cable is recommended. The connector on the RLI20 is a 4 way female Binder M9, the mating connector is shown in Figure 3. Pinouts are shown in Table 4.

Table 4 – Error connector pinout

Pin	Function
1	/Error
2	0 V
3	+5 V
4	Error
Shell	Chassis

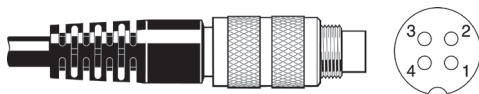

Figure 3 – 4 way male Binder

2.4 Power

The RLI20 power is supplied via a 4 way male M16 Binder, the mating connector is shown in Figure 4. Pinouts are shown in Table 5. This is identical to wiring requirements for RCU10 power connector.

Table 5 – Power connector pinout

Pin	Function
1	24 V
2	24 V
3	0 V
4	Chassis
Case	Chassis

The 24 V power supply should be single fault tolerant certified to EN (IEC) 60950-1.

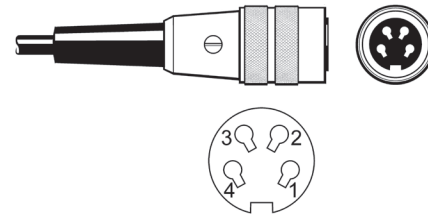

Figure 4 – 4 way female M16 Binder connector

2.5 Mechanical installation

The RLI20 is intended to be mounted in an electrical control cabinet or similar environment. It is constructed with IP40 protection and therefore needs to be protected from harsh environmental conditions.

For connector/cable clearance purposes, allow 100 mm (4 in) from the front face of the RLI20.

Note: Using the fixings supplied with the unit (M4 x 5 cap head screws and 4 mm plain washers) ensures that earthing is achieved directly through the brackets.

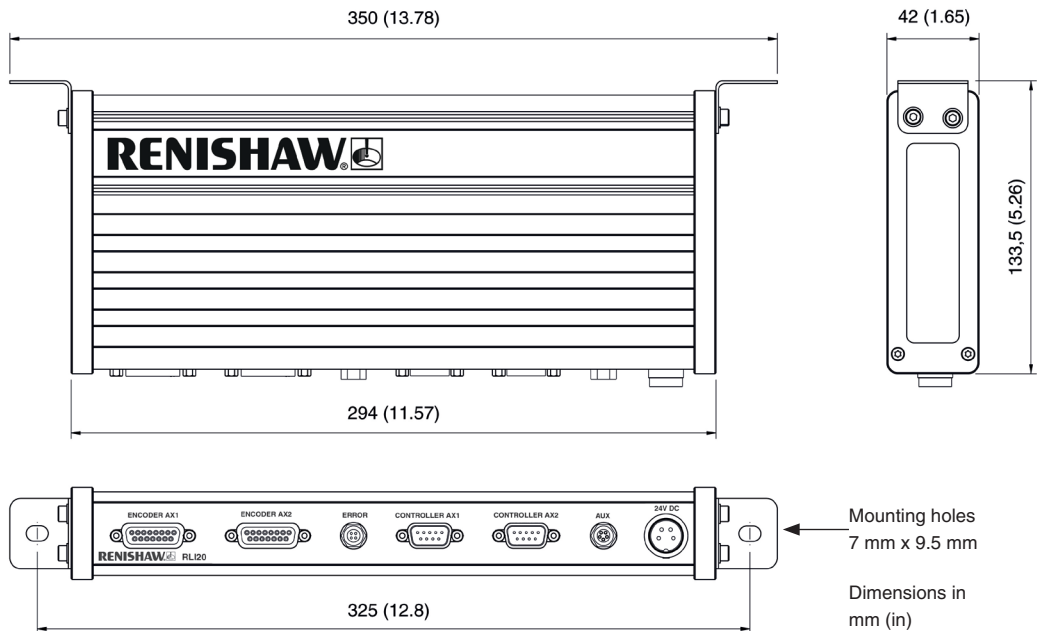

3 Configuration

3.1 RLE set-up – dip switches

If the RLI20 is being used with an RLE system, care should be taken setting the RLE configuration switches correctly.

Table 5 – Error connector pinout

Switch No.	Switch position	Description
5	Down	To give analogue quadrature output
11	Down	So the RLE does not tri-state the quadrature on error
12	Up	Unless the fine digital quadrature output from the RLE is also required (in addition to the RLI20 laser position output).
13	Down	So that the RLE does not latch errors. The RLI20 will latch any errors flagged

Note: The RLE axis direction reversal switches 6 and 7 only affect the direction of the digital quadrature from the RLE and not the analogue quadrature.

Note: The RLE will flag an error when the measurement velocity reaches a level at which the required output rate of the digital quadrature exceeds the digital bandwidth limit of the RLE. The digital bandwidth limit depends on the digital quadrature resolution and maximum output bandwidth selected with the RLE DIP switches. The digital quadrature resolution and the digital output bandwidth should be selected so that the RLE measurement velocity limit is sufficient for the application. It is therefore recommended that fine quadrature is disabled by setting RLE switch number 12 UP.

For further information on the RLE front panel switches refer to the RLE manual (M-5225-0568).

3.2 Position

Position output is scaled for 1 nm/lsb for PMI and 2 nm/lsb for RRI.

Axis 1 is scaled relative to RLE Axis 1 wavelength at NTP of 632.818270 nm.

Axis 2 is scaled relative to RLE Axis 2 wavelength at NTP of 632.819719 nm.

NTP is defined as 101,325Pa, 20°C, 50% RH, 450 ppm CO₂.

Ensure when connecting the RLE/HS20 to the RLI20 that the appropriate connector is connected to the relevant port (Axis 1/Axis 2).

Position is set to zero on power up and when the Panasonic controller is power cycled.



WARNING: If an error is signalled by the RLI20, then the RLI20 position data may be incorrect. The system must be reset and re-referenced before it is used for position feedback again.



WARNING: The position data will roll over when the RLI20 position range limit is exceeded. The stage controller should be programmed to account for this.



WARNING: It is important to check the direction sense correctly. If it is set incorrectly, the machine will move in the opposite direction to that expected, and may accelerate until it reaches the axis limits. In the case of parallel twin rail drives, it is important that the direction sense of the slave axis is set to match the master axis. Failure to do this will cause opposite ends of the cross-member to move in opposite directions, possibly causing damage to the machine.

3.3 Error output

RS422 compatible differential output.

Indicates an error on either channel or a hardware error.



WARNING: The error output is not a fail-safe method and therefore additional safety precautions must be taken in safety critical closed loop applications. The error line must be continually monitored and the motion system must be stopped if it is asserted.

Error bits returned to Panasonic controller as ALMC shown in table 6. Errors reported are for individual channel only.

Table 6 – ALMC error links

Bit	Function
7	Warning - Beam saturation (beam strength > 115%)
6	Warning - Beam low (beam strength < 25%)
5	Error - not used reads 0
4	Error - not used reads 0
3	Error - EEPROM CRC error during read of scale and offset settings - can't be cleared
2	Error - Beam break (beam strength < 12.5%)
1	Error - Overspeed
0	Error - Encoder error (from RLE)

Errors and warnings are cleared when the Panasonic controller is power cycled.

EEPROM CRC error can only be cleared by power cycling the RLI20.

3.4 LED indicators

Status Ax 1 / Status Ax 2.

Table 7 shows the axis status for a give LED colour illumination.

Table 7 – Status Ax 1 / Status Ax 2 LED indicators

LED	Status
Red	Error
Amber	Warning
Green	OK

Error

The error LED shows red under any hardware or axis error.

Power

The power LED shows green to indicate the device is powered up.

Appendix A – Specification

Values in this table define the contribution of the RLI20 on the system performance, not the complete laser interferometer system performance.

Measurement performance

		PMI†	RRI‡
LSB resolution		1 nm	2 nm
Maximum speed		1 m/s*	2 m/s*
Positional noise contribution (RMS)		1 nm	2 nm
SDE contribution	Velocity <50 mm/s (PMI) <100 mm/s (RRI) Serial strength >70% and <115%	<±0.5 nm	<±1 nm
	Velocity >50 mm/s and <1 m/s (PMI) >100 mm/s and <2 m/s (RRI)	<±2 nm	<±4 nm

* Panasonic interface is limited to 400 mm/sec

† Plane mirror interferometer

‡ Retroreflector interferometer

Dimensions

Length	350 mm (13.8 in)
Width	42 mm (1.65 in)
Depth	133.5 mm (5.26 in) not including connectors
Weight	1.0 kg

RLI20 power requirement

Voltage	24 ±5 V
Power	3 W

The 24 V power supply should be single fault tolerant certified to EN (IEC) 60950-1.

Environmental specification

Pressure	Normal atmospheric (650 mbar - 1150 mbar)
Humidity	0 - 95% RU (non-condensing)
Temperature (storage)	-20° C to +70° C
Temperature (operating)	+10° C to +40° C

Appendix B – Safety information

General

The RLI20 is designed for integration into the primary position feedback loop of a motion system. It is essential that the system is installed in accordance with the instructions in the installation manuals. It is the responsibility of the system integrator to ensure that, in the event of a failure of any part of the RLI20, the motion system remains safe.

In motion systems with powers or speeds capable of causing injury, safety protection measures must be included in the design. It is recommended that satisfactory operation of these protection measures is verified **before** the feedback loop is closed. The following are examples of safety protection measures that can be used. It is the sole responsibility of the system integrator to select appropriate measures for their application.

1. The RLI20 includes an error signal output. The control system must be designed to stop the axis motion if this error is asserted.
2. The axis must include physical limit switches which, when tripped, will stop axis motion before damage occurs (soft limits alone are insufficient).

3. Motor torque monitoring. If the motor torque exceeds an expected limit, the axis of motion must be stopped.
4. The machine must include an emergency stop button.
5. Following error detection, if the difference between the controller demand position and the axis feedback position exceeds an expected limit, the axis motion must be stopped.
6. Guards, viewing windows, covers and interlocks may be used to prevent user access to hazardous areas, and to contain ejected parts and materials.
7. If the machine includes an independent tacho (velocity) feedback system, this should be cross-checked with the position feedback. For example, if the tacho indicates the axis is moving, but the position feedback doesn't, the axis motion must be stopped.
8. In the case of synchronised parallel motion systems (for example twin rail gantry drive systems), the relative positions of master and slave axes should be monitored. If the difference in their positions exceeds an expected limit, axis motion must be stopped.

For further advice, consult the appropriate machinery safety standards.

Direction sense

It is important to check the direction sense correctly. If it is set incorrectly, the machine will move in the opposite direction to that expected, and may accelerate until it reaches the axis limits. In the case of parallel twin rail drives, it is important that the direction sense of the slave axis is set to match the master axis. Failure to do this will cause opposite ends of the cross-member to move in opposite directions, possibly causing damage to the machine.

Error signal monitoring

The RLI20 laser interface continuously checks for internal errors and errors in the encoder system that may cause invalid position feedback signals, and signals a fault by asserting an error line output. In the case of closed loop motion systems, for safe operation the status of this error line must be monitored. If the error line goes high, the position feedback signals may be incorrect and the axis of motion must be stopped.

Power supply out of range

The correct power supply voltage is 24 V \pm 5 V. Power supplies outside of this range may give unreliable operation or damage the RLI20 unit.

Position data integrity

If an error is signalled by the RLI20, then the RLI20 position data may be incorrect. The system must be reset and re-referenced before it is used for position feedback again.

Renishaw plc

New Mills, Wotton-under-Edge,
Gloucestershire, GL12 8JR
United Kingdom

T +44 (0)1453 524524

F +44 (0)1453 524901

E uk@renishaw.com

www.renishaw.com

RENISHAW 
apply innovation™

**For worldwide contact details,
please visit our main web site at
www.renishaw.com/contact**



M - 9926 - 0005 - 02