

Brake caliper machining: improve process control and reduce inspection costs

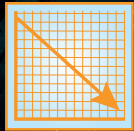

Reduce part costs



Full traceability



High accuracy automated shop floor gauging

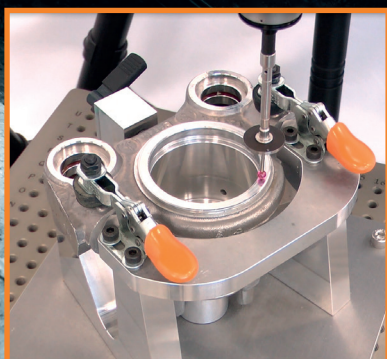

Overview

Manufacturers of brake calipers use high speed CNC machining of near-net shape brake caliper castings over a series of operations. The machined parts are then chemically treated to prevent corrosion before being assembled into brake systems.

Typically, shop floor measurement of brake calipers involves a series of dedicated bench gauges and specialised hand gauges. During a production run, each part is inspected to measure safety critical features such as seal grooves and piston bores. Inspection is carried out on 100% of parts.

This case brief examines an example brake caliper process with actual benefits that Renishaw technology has delivered to manufacturers who are under pressure to design, inspect and test parts as thoroughly as possible.

Example brake caliper manufacturing process* - without the Equator™ gauge

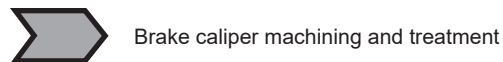
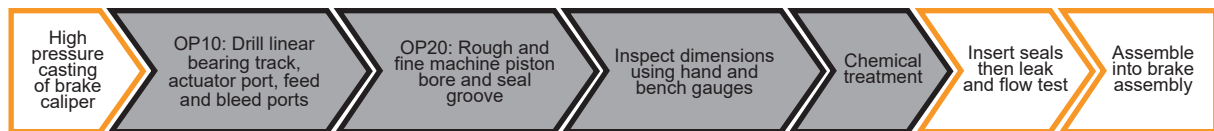

Brake caliper machining and treatment



*Other manufacturers' processes may differ.

Challenges

1 Combine all the gauging and inspection activities into a single operation

Each part requires multiple gauges and each bench gauge is dedicated to the inspection of one part design. New gauges are frequently required as parts change. Manual inspection of parts can be slow.

2 Accurately inspect parts despite a wide shop floor temperature range

Accuracy of parts must be maintained despite wide daily and seasonal shop floor temperature ranges.

3 Ensure traceability of inspection data

Current gauges provide simple pass/fail results and it is difficult to accurately record inspection data. Machine offset updates are applied, but not recorded.

Inspection requirements for a brake caliper

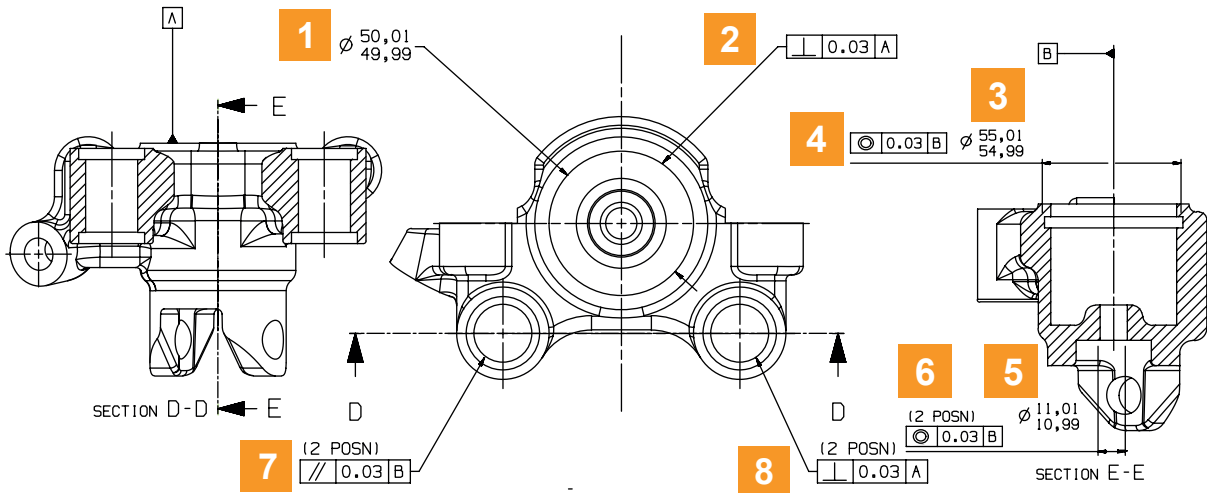

#	Inspection	Tolerance	Why is this feature critical to part function?	Active tool offsetting action
1	Piston bore diameter	±10 µm (±0.0004")	This ensures the piston runs true within the bore, without moving too freely or being too tight a fit.	
2	Perpendicularity of piston bore to front mounting face	30 µm (0.0012")	This affects the mounting of the brake assembly. Misalignment can reduce brake component life.	
3	Seal groove diameter	±10 µm (±0.0004")	The groove and seal must have a well controlled fit to the piston to prevent brake fluid from leaking.	
4	Concentricity of seal groove to piston bore	30 µm (0.0012")	This concentricity to the piston bore ensures that there is correct sealing around the piston.	
5	Actuator port diameter	±10 µm (±0.0004")	This ensures that the mechanical parking brake pin fits through the bore.	
6	Concentricity of actuator port to piston bore	30 µm (0.0012")	To ensure the mechanical parking brake pin applies even force to the piston to lock the brakes firmly on.	
7	Parallelism of linear bearing track 1 to bore hole	30 µm (0.0012")	This ensures correct alignment when mounting the brake assembly.	
8	Perpendicularity of linear bearing track 2 to bore hole	30 µm (0.0012")	This ensures correct alignment when mounting the brake assembly.	

Key:



Automatic update of machine offsets through inspection of indicated features.

Please note: In addition to the feedback of geometric features, the monitoring of form can be indicative of the health of the tools.

Process considerations

Renishaw engineers considered key elements within the brake caliper manufacturing process using Renishaw's **Productive Process Pyramid™**. This framework is used to identify and control the variations that can occur at key stages of the machining process.

For this process, methods to control variation include machine maintenance and calibration, tool breakage detection and shop-floor gauging for inspection and feedback.

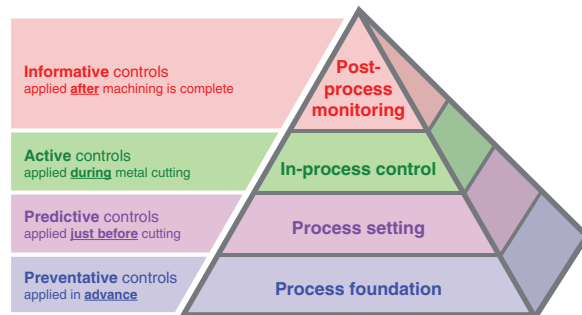

Productive Process Pyramid

Manufacturing process - opportunities for improvement

Original process



Improved process

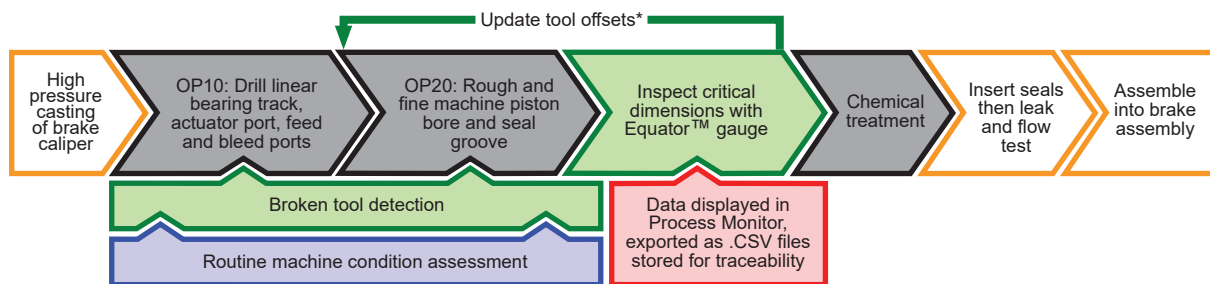

* Offset updates can be automatically applied using IPC (intelligent process control) software which uses dimensional data to feedback offset updates to CNC controllers. Updates could alternatively be applied manually based on the inspection data displayed in Process Monitor.

Typical results

A key action for brake caliper manufacturers has been to install the Equator gauging system to replace hand and bench gauges. Combining all gauging into one activity has delivered cost savings, eliminating the need to invest in new gauges. Equator gauges compare production parts against master part inspection data. Remastering removes thermal effects and ensures high repeatability of inspection results over a wide temperature range. Inspection results are captured in a way that enables easy reporting, analysis and feedback to improve process control.



Typical results

1 Combined single operation

Equator gauging systems are inspecting all dimensions including diameter, perpendicularity and concentricity for 100% of parts without the need for other inspection devices. The Equator systems are inspecting multiple product families and are reprogrammed to cope with new parts and design changes. The quantity of gauges required and the need to invest in new gauges have been significantly reduced as a result. The reduced inspection costs mean that parts are being produced at a reduced overall cost.

#	Inspection Total time: 1 min 40 secs	Tolerance	Gauge R&R % of tol*	Gauge R&R range*
1	Piston bore diameter	±10 µm (±0.0004")	7.4%	1.1 µm (43 µin)
2	Perpendicularity of piston bore to front mounting face	30 µm (0.0012")	1.9%	0.7 µm (28 µin)
3	Seal groove diameter	±10 µm (±0.0004")	7.6%	1.0 µm (39 µin)
4	Concentricity of seal groove to piston bore	30 µm (0.0012")	4.5%	2.2 µm (87 µin)
5	Actuator port diameter	±10 µm (±0.0004")	8.6%	1.1 µm (43 µin)
6	Concentricity of actuator port to piston bore	30 µm (0.0012")	5.5%	2.0 µm (79 µin)
7	Parallelism of linear bearing track 1 to bore hole	30 µm (0.0012")	2.0%	1.1 µm (43 µin)
8	Perpendicularity of linear bearing track 2 to bore hole	30 µm (0.0012")	2.1%	0.8 µm (31 µin)

* Type 1 Gauge Repeatability and Reproducibility - loading and unloading the same part 30 times.

2 Inspection over wide temperature range

Remastering the Equator gauging system maintains accuracy over daily and seasonal shop floor temperature cycles.

Equator gauges have in-built temperature sensors. When the temperature rises above an acceptable level a warning message is displayed to the operator informing them to remaster. The operator runs the remastering sequence, which takes the same time as inspecting a production part, and re-zeros the Equator system at the current temperature.

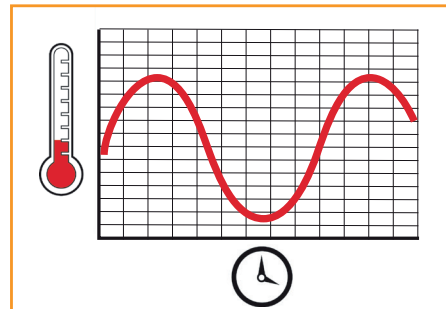

3 Traceable process control

Process Monitor is part of the software package which runs on Equator gauging systems. Process Monitor includes an instant status monitor bar graph of the last measured part and historical results for the selected feature. Previously operators were only receiving pass/fail data. Now the inspection results from the Equator gauge are exported as .CSV files and stored for traceability. These results are also being used to update machine offsets, bringing drifting processes back in-line before scrap parts are produced.

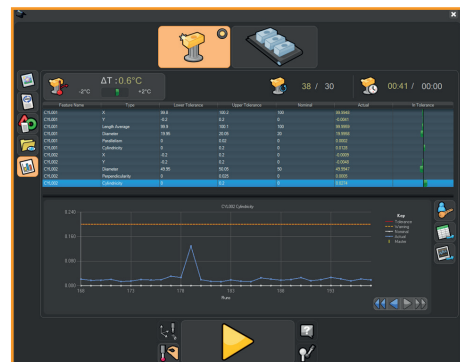

About Renishaw

Renishaw is an established world leader in engineering technologies, with a strong history of innovation in product development and manufacturing. Since its formation in 1973, the company has supplied leading-edge products that increase process productivity, improve product quality and deliver cost-effective automation solutions.

A worldwide network of subsidiary companies and distributors provides exceptional service and support for its customers.

Products include:

- Additive manufacturing and vacuum casting technologies for design, prototyping, and production applications
- Dental CAD/CAM scanning systems and supply of dental structures
- Encoder systems for high-accuracy linear, angle and rotary position feedback
- Fixturing for CMMs (co-ordinate measuring machines) and gauging systems
- Gauging systems for comparative measurement of machined parts
- High-speed laser measurement and surveying systems for use in extreme environments
- Laser and ballbar systems for performance measurement and calibration of machines
- Medical devices for neurosurgical applications
- Probe systems and software for job set-up, tool setting and inspection on CNC machine tools
- Raman spectroscopy systems for non-destructive material analysis
- Sensor systems and software for measurement on CMMs
- Styli for CMM and machine tool probe applications

For worldwide contact details, visit www.renishaw.com/contact



RENISHAW HAS MADE CONSIDERABLE EFFORTS TO ENSURE THE CONTENT OF THIS DOCUMENT IS CORRECT AT THE DATE OF PUBLICATION BUT MAKES NO WARRANTIES OR REPRESENTATIONS REGARDING THE CONTENT. RENISHAW EXCLUDES LIABILITY, HOWSOEVER ARISING, FOR ANY INACCURACIES IN THIS DOCUMENT.

© 2019 Renishaw plc. All rights reserved.

Renishaw reserves the right to change specifications without notice.

RENISHAW and the probe symbol used in the RENISHAW logo are registered trade marks of Renishaw plc in the United Kingdom and other countries. apply innovation and names and designations of other Renishaw products and technologies are trade marks of Renishaw plc or its subsidiaries.

All other brand names and product names used in this document are trade names, trade marks or registered trade marks of their respective owners.



H - 5504 - 8810 - 03

Part no.: H-5504-8810-03-A
Issued: 06.2019