

OSI/OSI-D with OMM-2C multiple optical probe interface system



© 2017–2022 Renishaw plc. All rights reserved.

This document may not be copied or reproduced in whole or in part, or transferred to any other media or language, by any means, without the prior written permission of Renishaw plc.

Renishaw plc. Registered in England and Wales. Company no: 1106260. Registered office: New Mills, Wotton-under-Edge, Gloucestershire, GL12 8JR, UK.

Compliance information for this product is available by scanning the QR code or visiting www.renishaw.com/mtpdoc



Renishaw part no:	H-5991-8504-03-B
First issued:	05.2017
Revised:	11.2018
	02.2019
	09.2022

Contents

Before you begin	1.1
Disclaimer	1.1
Trade marks	1.1
Warranty	1.1
CNC machines	1.1
Care of the system components	1.1
Patents	1.2
Intended use	1.2
Safety	1.3
OSI/OSI-D with OMM-2C basics	2.1
Introduction	2.1
OSI-D interface	2.1
OSI/OSI-D inputs	2.2
OSI/OSI-D outputs	2.2
OSI components	2.4
OSI-D components	2.5
OMM-2C (A) connector (7-way/15-way)	2.6
OMM-2C (B) connector (7-way)	2.6
Control connector block (15-way)	2.6
Switch SW1 output configuration	2.7
Switch SW2 output configuration	2.8
OSI/OSI-D input mode configurations	2.9
Single probe mode	2.9
Multiple probe mode	2.9
Switch-on / switch-off method	2.11
Start-up times	2.11
Synchronisation recovery	2.11
Multiple probe mode timing diagrams	2.12
OSI/OSI-D output waveforms	2.13

OSI/OSI-D dimensions	2.14
OSI/OSI-D/ specification	2.14
OMM-2C visual diagnostics – system status LEDs.	2.15
START SIGNAL (blue, yellow, violet)	2.16
ACTIVE SYSTEM (blue, yellow, violet)	2.16
ERROR and STANDBY (red)	2.16
OVERCURRENT (flashing red)	2.16
CORRUPTED SIGNAL (white).	2.16
OMM-2C dimensions.	2.17
OMM-2C specification.	2.17
OSI/OSI-D with OMM-2C system used in single probe mode.	2.18
OSI/OSI-D with OMM-2C system used in multiple probe mode	2.19
System installation	3.1
Typical OMM-2C system installation	3.1
Introduction	3.1
Single configuration	3.1
Tandem configuration.	3.2
OMM-2C application	3.3
OMM-2C cable	3.3
Mounting the OSI/OSI-D to a DIN rail	3.4
Performance envelope of OMM-2C with OMP600 or OMP60	3.5
Performance envelope of	3.6
OMM-2C with OMP400, OMP40-2 or OLP40	3.6
Performance envelope of	3.7
OMM-2C with OTS	3.7
Wiring diagram (with output groupings shown)	3.8
Integral airblast installation (optional)	3.9
Integral airblast application.	3.9
Connecting and purging the air supply.	3.9
Maintenance	4.1
Maintenance	4.1
Cleaning the interface	4.1
Removing the OMM-2C	4.2
Maintenance – air regulator unit.	4.3
Fault-finding	5.1
Parts list	6.1

Before you begin

Disclaimer

WHILE CONSIDERABLE EFFORT WAS MADE TO VERIFY THE ACCURACY OF THIS DOCUMENT AT PUBLICATION, ALL WARRANTIES, CONDITIONS, REPRESENTATIONS AND LIABILITY, HOWSOEVER ARISING, ARE EXCLUDED TO THE EXTENT PERMITTED BY LAW.

RENISHAW RESERVES THE RIGHT TO MAKE CHANGES TO THIS DOCUMENT AND TO THE EQUIPMENT, AND/OR SOFTWARE AND THE SPECIFICATION DESCRIBED HEREIN WITHOUT OBLIGATION TO PROVIDE NOTICE OF SUCH CHANGES.

Trade marks

RENISHAW® and the probe symbol are registered trade marks of Renishaw plc. Renishaw product names, designations and the mark 'apply innovation' are trade marks of Renishaw plc or its subsidiaries.

Other brand, product or company names are trade marks of their respective owners.

Warranty

Unless you and Renishaw have agreed and signed a separate written agreement, the equipment and/or software are sold subject to the Renishaw Standard Terms and Conditions supplied with such equipment and/or software, or available on request from your local Renishaw office.

Renishaw warrants its equipment and software for a limited period (as set out in the Standard Terms and Conditions), provided that they are installed and used exactly as defined in associated Renishaw documentation. You should consult these Standard Terms and Conditions to find out the full details of your warranty.

Equipment and/or software purchased by you from a third-party supplier is subject to separate terms and conditions supplied with such equipment and/or software. You should contact your third-party supplier for details.

CNC machines

CNC machine tools must always be operated by fully trained personnel in accordance with the manufacturer's instructions.

Care of the system components

Keep system components clean and treat with care. Do not apply labels to the front of the OMM-2C or otherwise obstruct the window.

Patents

None applicable.

Intended use

The OSI/OSI-D with OMM-2C acts as a separate machine interface and optical transceiver, which converts signals from the optical probe into voltage-free solid state relay (SSR) and driven outputs for transmission to the CNC machine controller.

Safety

Information to the user

In all applications involving the use of machine tools or CMMs, eye protection is recommended.

The OMM-2C has a glass window. Handle with care if broken to avoid injury.

Information to the machine supplier/ installer

It is the machine supplier's responsibility to ensure that the user is made aware of any hazards involved during operation, including those mentioned in Renishaw product literature, and to ensure that adequate guards and safety interlocks are provided.

Under certain circumstances, the probe signal may falsely indicate a probe seated condition. Do not rely on probe signals to halt the movement of the machine.

Information to the equipment installer

All Renishaw equipment is designed to comply with the relevant EU and FCC regulatory requirements. It is the responsibility of the equipment installer to ensure that the following guidelines are adhered to, in order for the product to function in accordance with these regulations:

- any interface **MUST** be installed in a position away from any potential sources of electrical noise, i.e. power transformers, servo drives etc;
- all 0 V/ground connections should be connected to the machine "star point" (the "star point" is a single point return for all equipment ground and screen cables). This is very important, and failure to adhere to this can cause a potential difference between grounds;
- all screens must be connected as outlined in the user instructions;
- cables must not be routed alongside high-current sources, i.e. motor power supply cables etc, or be near high-speed data lines;
- cable lengths should always be kept to a minimum.
- the dc supply to this equipment must be derived from a source which is approved to BS EN IEC 62368-1.

Equipment operation

If this equipment is used in a manner not specified by the manufacturer, the protection provided by the equipment may be impaired.

Optical safety

This product contains LEDs that emit both visible and invisible light.

OMM-2C is ranked Risk Group: Exempt (safe by design).

The product was evaluated and classified using the following standard:

BS EN 62471:2008 The photobiological safety of lamps and lamp systems.

Renishaw recommends that you do not stare at or look directly into any LED device, irrespective of its risk classification.

This page is intentionally left blank.

OSI/OSI-D with OMM-2C basics

Introduction

CNC machine tools using Renishaw spindle probes with optical signal transmission for workpiece inspection, or tool setters with optical signal transmission, require an interface system to convert the signals from the probe into voltage-free solid state relay (SSR) outputs for transmission to the CNC machine controller.

Typically installed within the CNC machine controller's cabinet and located away from sources of interference such as transformers and motor controls, the OSI can draw its power from the machine's nominal 12 Vdc to 30 Vdc supply.

The OSI has an input voltage range of 12 Vdc to 30 Vdc. The supply is protected by a 1.1 A self-resetting fuse (the current, when connected to an OMM-2C, is either 400 mA max. @ 12 V or 200 mA max. @ 24 V with tandem OMM-2C). To reset the fuse, remove the power then identify and rectify the cause of the fault.

The OSI can be used with either a single or tandem OMM-2C configuration, housed within the machining environment. The OMM-2C is an optical receiver designed for fitment in the machine spindle. It transmits control signals to the spindle probe or tool setter, and receives probe data signals for onward transmission to the OSI and CNC controller. Power is supplied from the OSI interface. Visual indication of system status is provided via the LEDs located on the OMM-2C.

The OSI with OMM-2C system operates using a 'modulated' optical transmission mode and is compatible with machine probes that also operate in 'modulated' mode.

When in operation, the OMM-2C displays its present status via three multi-coloured LEDs located behind the front window (see "OMM-2C visual diagnostics – system status LEDs" on page 2.15).

OSI-D interface

The OSI-D interface is a variant of the standard OSI interface, and has been designed for easy installation to CNC machine controllers using a 15-way HD D type connector for probe input.

The OSI-D interface shares all functionality and wiring connections with the standard OSI interface, the only difference being the OMM-2C connector (A).

NOTE: Throughout this installation guide, the term OSI and any OSI images refers to both OSI or OSI-D, unless otherwise specified.

OSI/OSI-D inputs

There are three inputs:

- Probe 1 start
- Probe 2 start
- Probe 3 start

Switch SW2 can be configured to accept either a pulsed output or level output from the machine control.

Probe 1 start

Level	8 V to 30 V (4 mA @ 15 V, 7 mA @ 24 V) When the input is active, the probe is switched on.
Pulsed	8 V to 30 V (4 mA @ 15 V, 7 mA @ 24 V) The probe toggles between being switched on and off. The minimum pulse width is 10 ms.

Probe 2 and probe 3 start

Level	10 V to 30 V (10 mA @ 24 V) When the input is active, the probe is switched on.
Pulsed	10 V to 30 V (10 mA @ 24 V) The probe toggles between being switched on and off. The minimum pulse width is 10 ms.

The OSI uses level and pulsed machine inputs to define the active probe. When the respective input is active, the probe is switched on.

If all inputs are simultaneously active, the system will default to error.

OSI/OSI-D outputs

There are four outputs:

- Probe status 1 (SSR)
- Probe status 2 (SSR)
- Error (SSR)
- Low battery (SSR)

All outputs can be inverted by using switch SW1, (see “Switch SW1 output configuration” on page 2.7).

Probe status 1, Error, Low battery (SSR):

- ‘On’ resistance = 50 Ω max.
- Load voltage = 40 V max.
- Load current = 100 mA max.

Switching times (with 10 mA load)

- Open to closed = 100 μ s max.
- Closed to open = 25 μ s max.

Both probe status outputs indicate the status of the selected probe (only one probe can be selected at a time). They are both individually configurable.

The OMM-2C LEDs will start flashing red when an output overload has occurred. Probe status output will be triggered (SSR open). If this occurs, turn off the power supply and remove the source of the problem. Turning on the power supply will reset the OSI.

CAUTIONS:

Power supply voltage

Do not exceed 30 V between the following:

- the 0 V and the screen wire;
- the 12 V to 30 V supply wire and screen wire;
- the 12 V to 30 V supply wire and 0 V wires.

This could result in permanent damage to the OSI, OMM-2C and/or the power supply.

The use of in-line fuses at the machine cabinet end is recommended to provide protection for the OSI, OMM-2C and cable.

Screen connection

A good connection must be made to the machine ground ('star point').

Output

Ensure the output from the OSI does not exceed the specified current ratings.

OSI components

The following components are housed within the front face of the OSI (as shown in the figure below):

- OMM-2C (A) connector (7-way);
- OMM-2C (B) connector (7-way);
- Control connector block (15-way);
- SSR configuration switch SW1.

The following components are housed within the body of the OSI:

- Mode configuration switch SW2.

Access to switch SW1 and switch SW2 is required during installation only.

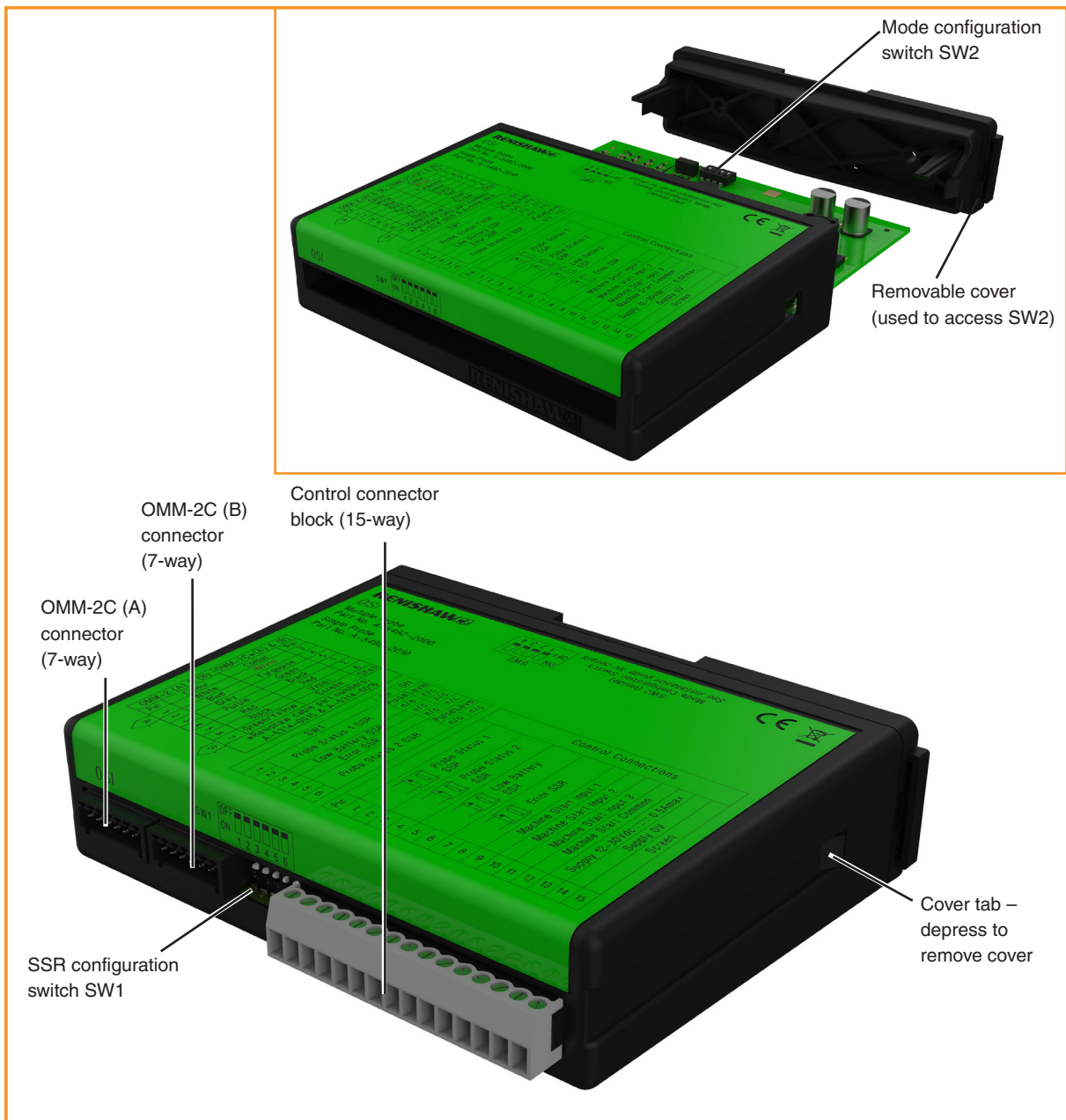

OSI-D components

The following components are housed within the front face of the OSI-D (as shown in the figure below):

- OMM-2C (A) connector (15-way HD D type);
- OMM-2C (B) connector (7-way);
- Control connector block (15-way);

The following components are housed within the body of the OSI-D:

- SSR configuration switch SW1.
- Mode configuration switch SW2.

Access to switch SW1 and switch SW2 is required during installation only.

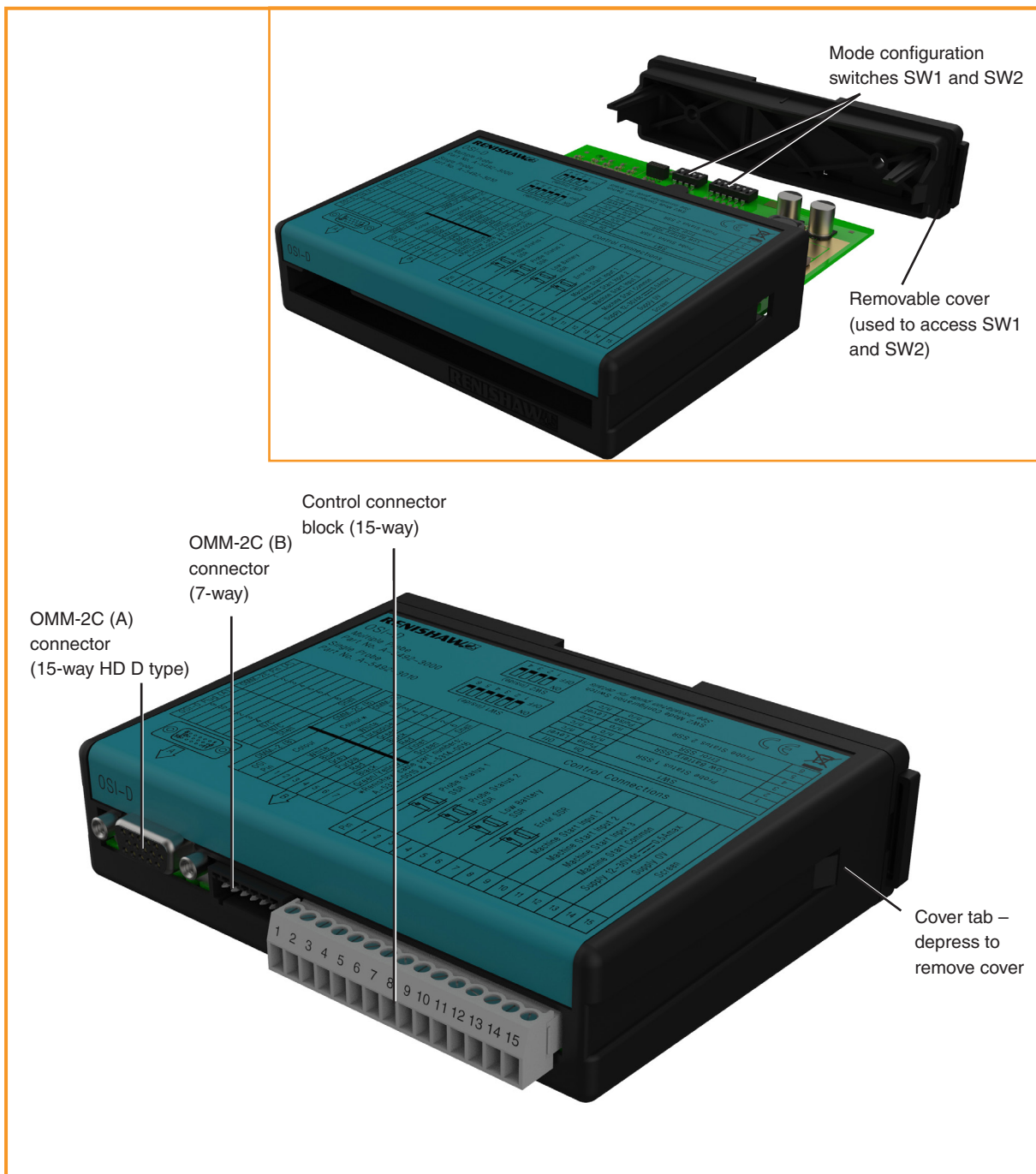

OMM-2C (A) connector (7-way/15-way)

OSI

This is a seven-pin connector and is designed to connect to the Renishaw OMM-2C.

OSI-D

This is a fifteen-pin D type connector and is designed to connect to the Renishaw OMM-2C.

OMM-2C (B) connector (7-way)

This is a seven-pin connector and is designed to connect to the Renishaw OMM-2C.

Control connector block (15-way)

This is a fifteen-pin connector and is designed to connect the OSI to the CNC machine controller and appropriate power supply as follows:

Pins 1 and 2 are used to connect the 'Probe status 1 SSR' function.

Pins 3 and 4 are used to connect the 'Probe status 2 SSR' function.

Pins 5 and 6 are used to connect the 'Low battery SSR' function.

Pins 7 and 8 are used to connect the 'Error SSR' function.

Pins 9 to 12 are used to supply a start signal to the probe:

- pin 9 is used to transmit a 'Machine start input 1' signal;
- pin 10 is used to transmit a 'Machine start input 2' signal;
- pin 11 is used to transmit a 'Machine start input 3' signal;
- pin 12 is used as 'Machine start common'.

Pins 13 to 15 are used to supply power and screen earth to the interface.

Switch SW1 output configuration

Switch SW1 enables the user to configure the probe system SSR outputs.

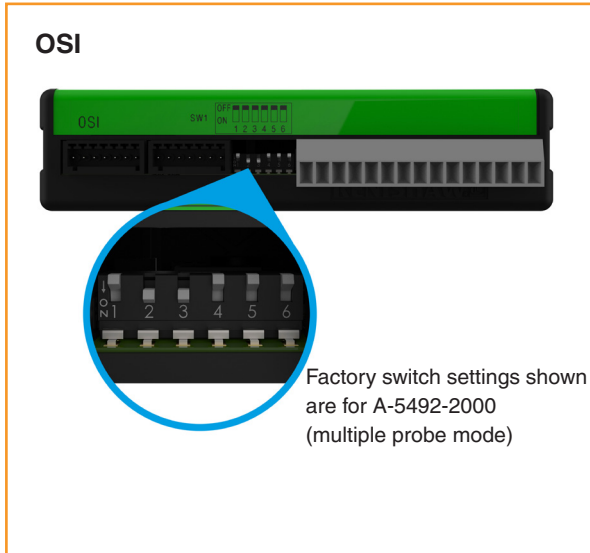

Pin	SW1	ON	OFF
1	Probe status 1 SSR	Pulse	Level
2		Normally open	Normally closed
3	Low battery SSR	Normally open	Normally closed
4	Error SSR	Normally open	Normally closed
5	Probe status 2 SSR	Pulse	Level
6		Normally open	Normally closed

CAUTION: Take electrostatic discharge (ESD) precautions when handling the PCB.

Switch SW2 output configuration

Switch SW2 enables the user to configure the OSI to be used in either single probe mode or multiple probe mode.



Mode	Switch settings				Visual representation
	POLE				
	1	2	3	4	
Single probe mode, Auto Start off, pulsed machine M-code. (Factory setting for A-5492-2010 and A-5492-3010)	ON	OFF	OFF	OFF	
Single probe mode, Auto Start off, level machine M-code.	ON	OFF	OFF	ON	
Single probe mode, Auto Start on.	ON	ON	OFF	OFF	
Multiple probe mode, two machine M-codes, short time delay of 10 ms.	OFF	ON	OFF	OFF	
Multiple probe mode, two machine M-codes, medium time delay of 50 ms.	OFF	ON	ON	OFF	
Multiple probe mode, two machine M-codes, long time delay of 100 ms.	OFF	ON	OFF	ON	
Multiple probe mode, three machine M-codes, level start. (Factory setting for A-5492-2000 and A-5492-3000)	OFF	OFF	ON	ON	
Multiple probe mode, three machine M-codes, common start, pulsed machine output.	OFF	OFF	OFF	OFF	
Multiple probe mode, three machine M-codes, common start, level machine output.	OFF	OFF	OFF	ON	

OSI/OSI-D input mode configurations

Single probe mode

Single probe mode enables one Renishaw probe to be operated. The probe should be configured as Probe 1.

Single probe mode provides the option for Auto Start to be selected. With Auto Start on, the system will send a start signal once every second if the probe is off and does not require a CNC machine output.

Auto Start should only be used when no output from the machine control is available. If Auto Start is selected, care should be taken to ensure system signals are not being received from probing systems on other machines.

If Auto Start is off, the interface will respond to an output from the machine controller. Switch SW2 can be configured to accept either a pulsed output or a level output.

In pulsed mode the interface will react to a pulse width of 10 ms minimum from a leading edge signal.

In level mode the probe will be off when the level is low, and on when the level is high.

Multiple probe mode

Multiple probe mode enables two or three Renishaw probes to be operated. This can be achieved by using either two or three outputs from the machine controller.

If two machine outputs (for three probes) are used, a coded switch-on technique is used to switch on / switch off the selected probe. When using this technique, it is necessary for the two machine outputs to be sent in short succession by the controller. To allow for a delay between the machine outputs, three user-selectable options are provided:

- a short time delay of 10 ms;
- a medium time delay of 50 ms;
- a long time delay of 100 ms.

If three machine outputs are used, the following start configurations are available which provide flexibility for interface integration.

Dedicated start (level mode)

In dedicated start, a machine start input is required per probe that is configured for optical switch-on.

Machine start inputs			Probe selected
P1	P2	P3	
			None
★			Probe 1 on
	★		Probe 2 on
		★	Probe 3 on

★ Machine start input active. Any attempt to switch on more than one probe simultaneously will result in an error condition.

Common start (level mode)

In common start (level mode), machine start inputs P2 and P3 are used to select the probe, and machine start input P1 is used to start the selected probe. All inputs are level.



Machine start inputs P1, P2 and P3			Probe selected
Probe start P1	Probe selection inputs		
	P2	P3	
★			Probe 1
★	★		Probe 2
★		★	Probe 3

★ Machine start input active. When P1 is off, all probes are off. When P1 is active, the selected probe will be on.

NOTE: Any change to the probe selection inputs P2 and P3 whilst the probe is operating will result in an error condition.

Common start (pulsed mode)

In common start (pulsed mode), machine start inputs P2 and P3 are level inputs used to select the probe. Machine start input P1 is a pulsed input used to start the selected probe.

Machine start inputs P1, P2 and P3			Probe selected
Probe start P1	Probe selection inputs†		
	P2†	P3†	
			Probe 1
	★		Probe 2
		★	Probe 3

 Machine start input pulsed, so the selected probe will change state.

† Probe selection inputs are level signals.

★ Machine start input active.

NOTES:

OMP600, OMP400, OMP60, OMP40-2, OLP40 or OTS can be configured as Probe 1, Probe 2 or Probe 3.

For more information, see your probe installation guide or contact your local Renishaw office.

Switch-on / switch-off method

Single probe mode

In pulsed or level mode, the following switch-on / switch-off methods may be used.

- Optical on / optical off
- Optical on / time off
- Spin on / spin off
- Spin on / time off
- Shank switch on / shank switch off

For Auto Start, only the following switch-on / switch-off method may be used.

- Optical on / time off

Multiple probe mode

In multiple probe mode, only the following switch-on / switch-off method may be used.

- Optical on / optical off

Start-up times

For information on probe start-up times, see “Multiple probe mode timing diagrams” on page 2.12.

The switch-off time is 0 seconds.

When changing from one selected probe to another, allow 1 second between the cancelling of one machine start input (machine output) and raising of the other start input.

Synchronisation recovery

Under abnormal operating situations, when used in multiple probe mode, the system may lose synchronisation between the receiver and the probes. An internal synchronisation recovery will be initiated when the next machine input is received.

The maximum time for system recovery from an abnormal operating situation is 7.5 seconds. Such a time delay could cause a machine alarm if controllers require ready signals within less than 5.5 seconds.

Multiple probe mode timing diagrams

Two machine outputs (for three probes)

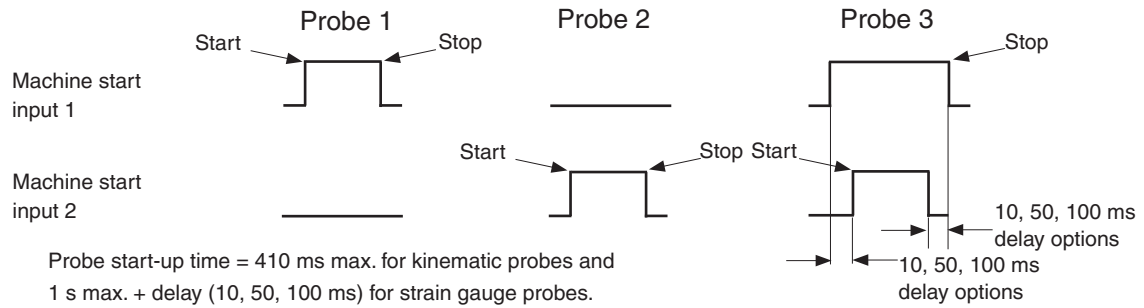

Three machine outputs (Dedicated start)

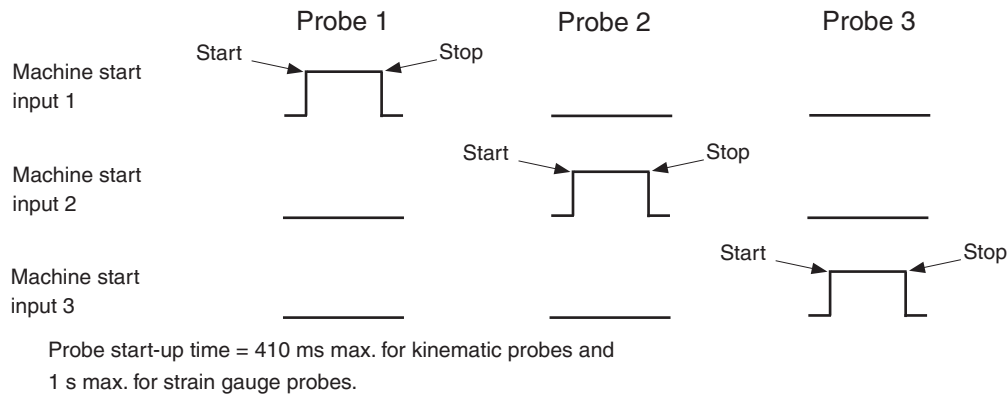

Three machine outputs (Common start / pulsed mode)

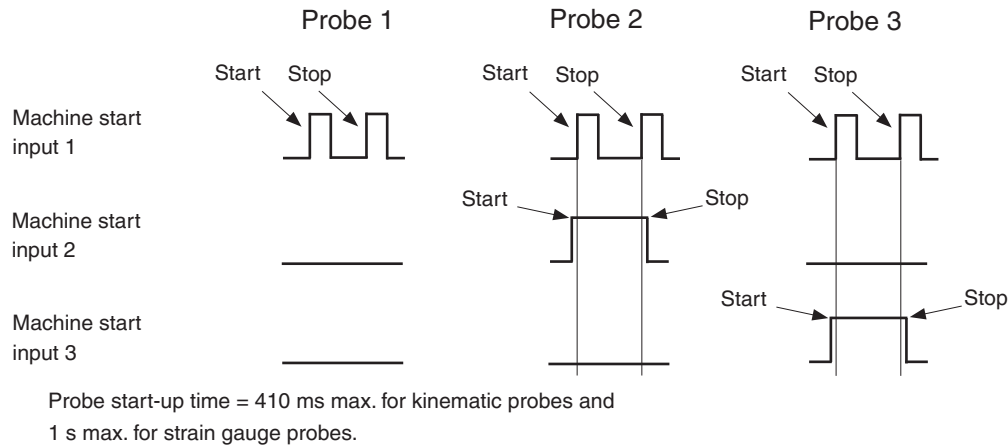

Three machine outputs (Common start / level mode)

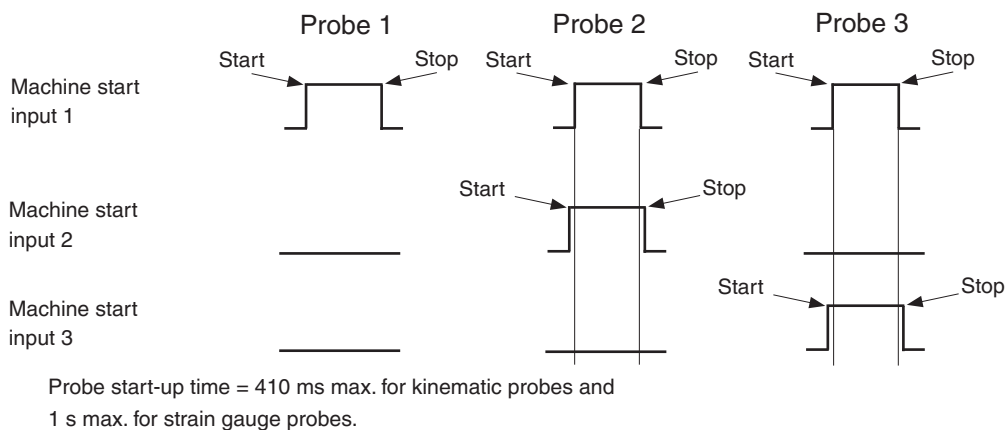

OSI/OSI-D output waveforms

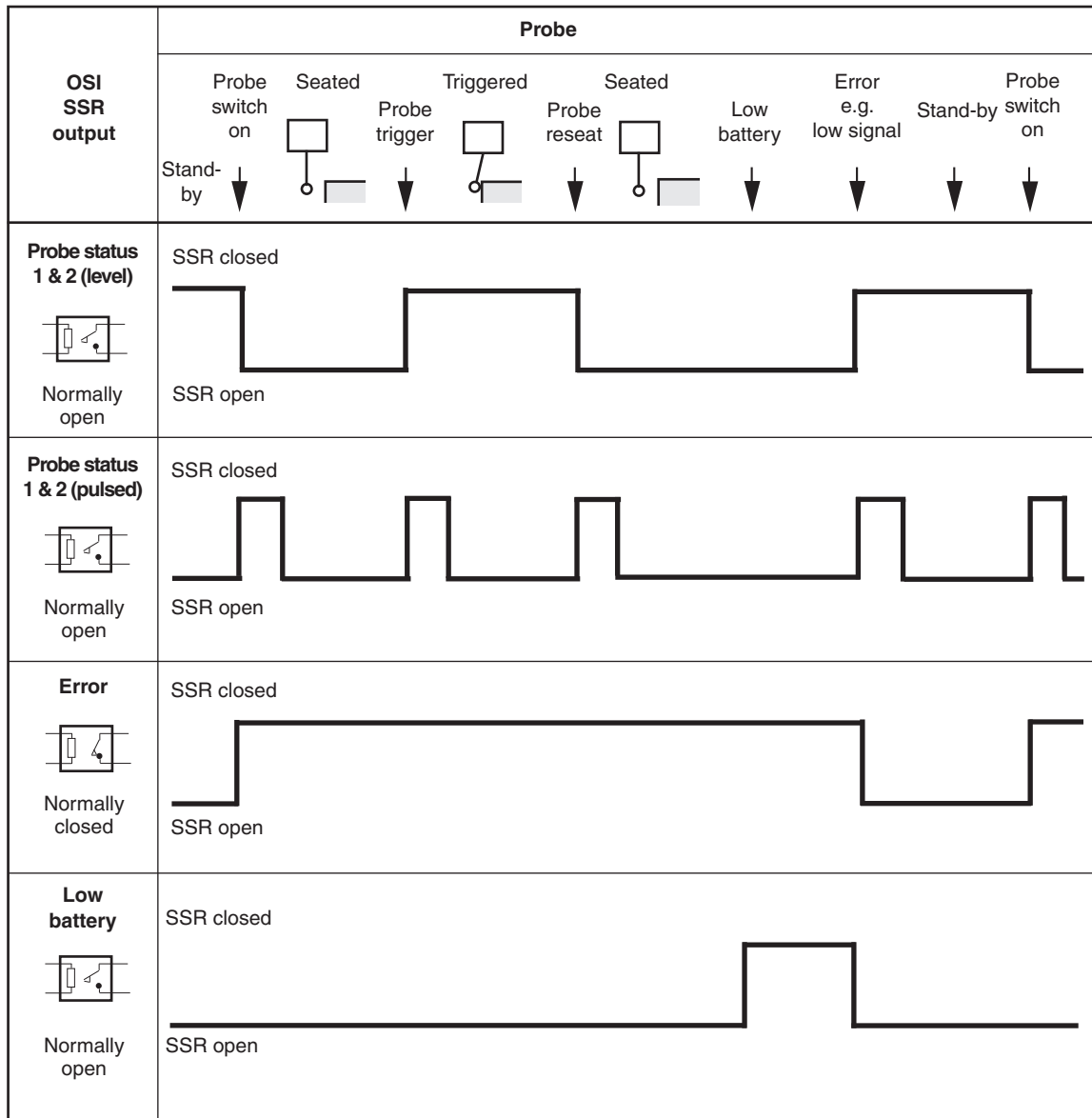

Signal delays

Transmission delay From probe trigger to output change of state = 2.5 ms max.

NOTE: Pulsed outputs are 40 ms ± 1 ms duration

OSI/OSI-D dimensions

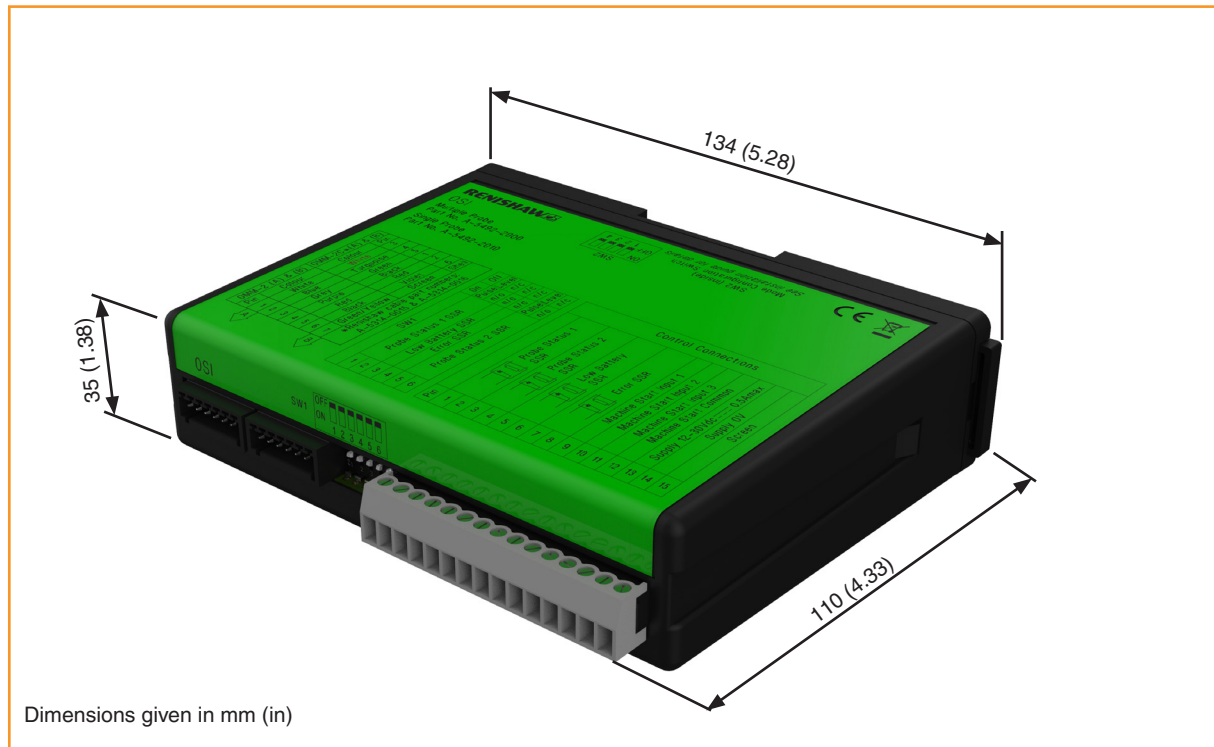

OSI/OSI-D/ specification

Principal application	The OSI processes signals from RENGAGE™ or standard probes via single or tandem OMM-2Cs or OMM-2s and converts them into machine outputs, which are then transmitted to the CNC control. The system allows up to three probes to be used with one interface.	
Transmission type	Infrared optical transmission (modulated)	
Probes per system	Up to three	
Supply voltage	12 Vdc to 30 Vdc	
Supply current	200 mA max. @ 24 V with tandem OMM-2C	
Configurable M-code input	Pulsed or level	
Output signals	Probe Status 1, Probe Status 2, Low Battery, Error Voltage-free solid-state relay (SSR) outputs, configurable as normally open or normally closed.	
Input/output protection	Supply protected by a 1.1 A resettable fuse. Outputs protected by overcurrent protection circuit.	
Environment (as defined in BS EN 61010-1:2001)	IP rating	IP20, BS EN 60529:1992+A2:2013
	Storage temperature	-10 °C to +70 °C (14 °F to 158 °F)
	Operating temperature	+5 °C to +55 °C (+41 °F to +131 °F)

OMM-2C visual diagnostics – system status LEDs

A visual indication of system status is provided by three LEDs. Indication is provided for:

- START SIGNAL;
- ACTIVE SYSTEM;
- ERROR and STANDBY;
- OVERCURRENT;
- CORRUPTED SIGNAL.



START SIGNAL (blue, yellow, violet)

This will flash when a machine control start signal is commanded; blue denotes Probe 1 start, yellow denotes Probe 2 start and violet denotes Probe 3 start.

A successful probe start will cause the 'ACTIVE SYSTEM' LED to become lit and a failed start will result in an 'ERROR' being displayed.

ACTIVE SYSTEM (blue, yellow, violet)

In single probe mode the system will be constantly lit blue to show that the input is active.

In multiple probe mode the system will be constantly lit blue to denote Probe 1 is active, yellow to denote Probe 2 is active and violet to denote Probe 3 is active.

If any ambiguous start information is received, the system will flash repeatedly (blue – yellow – violet – cyan) in sequence until the start input is cleared.

ERROR and STANDBY (red)

When lit constant red it indicates a transmission error condition, such as optical beam obstructed / probe out of optical range / probe switched off (standby) / dead battery.

OVERCURRENT (flashing red)

The system will start flashing red when an output overload has occurred. All outputs will be switched off.

If this occurs, turn off the power and remove the source of the problem. Turning on the power supply will reset the system.

CORRUPTED SIGNAL (white)

If the system displays a constant white LED, then either a second modulated probe signal has been received or the probe trigger instant has been delayed due to interference or a weak probe signal.

NOTE: In single probe mode the constant white error condition resulting from the loss of a good probe signal will persist until the machine start is activated or 1 hour has elapsed. In multiple probe mode the indication will persist until the active system input (Probe1, Probe 2 or Probe 3) is deactivated.

Key to the symbols ● LED short flash ■ LED solid on

Command		LED display
Error / standby		
Operating	Probe 1	
	Probe 2	
	Probe 3	
Overcurrent protection		
Failed start (1 second flash of attempted probe start)	Probe 1	
	Probe 2	
	Probe 3	
Invalid start signal		
Interference or second probe received		
Single probe mode with Auto Start	Auto Start mode only standby	
	Auto Start mode second probe signal received	

OMM-2C dimensions

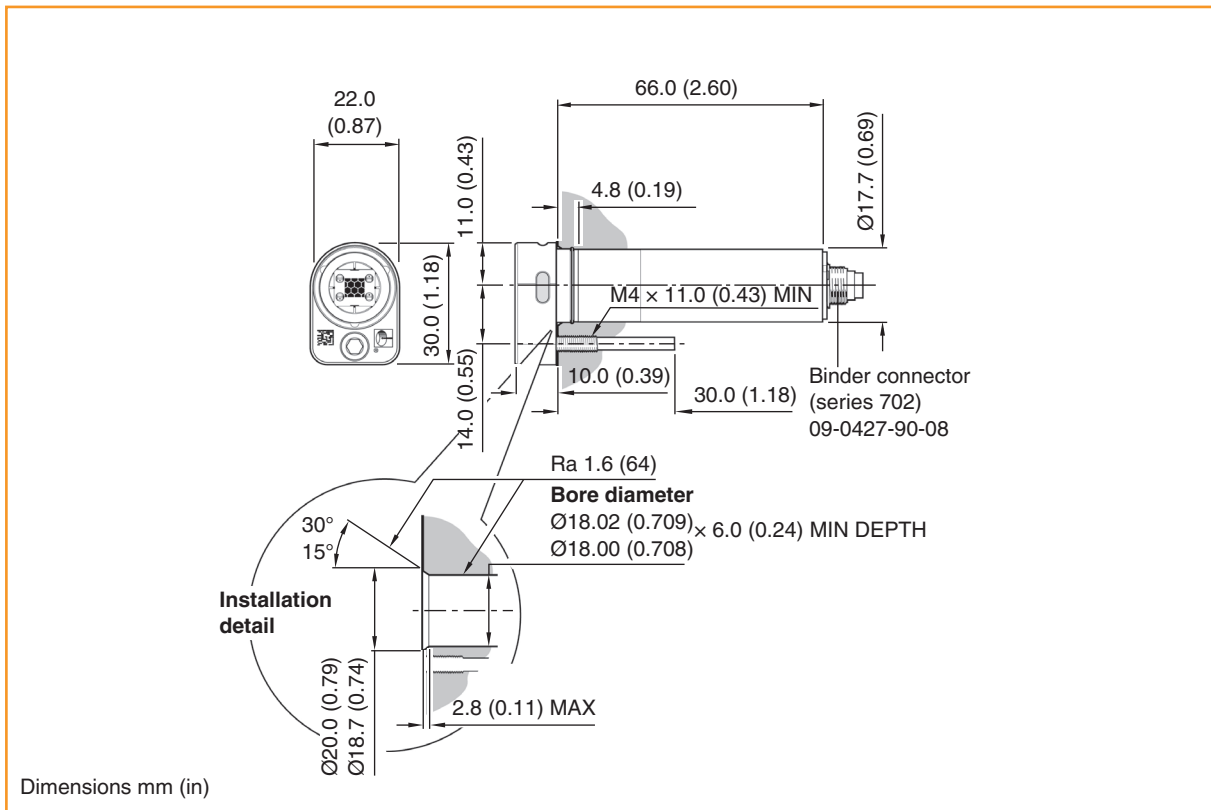

OMM-2C specification

Principal application	The OMM-2C transmits control signals to the probe and receives probe data signals for onward transmission to the OSI and CNC control.	
Transmission type	Infrared optical transmission (modulated)	
Probes per system	Up to three	
Compatible probes	OMP40-2, OMP40M, OLP40, OMP60, OMP60M, OMP400, OMP600 and OTS	
Operating range	Up to 3 m (9.8 ft)	
Weight (excluding cable)	with airblast	80 g (2.82 oz)
	without airblast	80 g (2.82 oz)
Cable (not supplied)	Specification	Ø4.75 mm (0.19 in), 12 core screened cable each core 7 × 0.1 mm
	Length	8 m (26.2 ft), 15 m (49.2 ft)
Mounting	Specifically designed for mounting in the machine spindle.	
Diagnostic LEDs	Start, error, active system and signal condition.	
Pneumatic supply	Ø3 mm (0.12 in) pneumatic fitting, 9 bar (130.5 psi) max. The air supply to the OMM-2C must conform to ISO 8573-1: Class 1.7.2.	
Environment	IP rating	IPX6, BS EN 60529:1992+A2:2013 [for product] IPX8, BS EN 60529:1992+A2:2013 [for glass window]
	IK rating	IK04, BS EN 62262:2002+A1:2021 [for glass window]
	Storage temperature	-25 °C to +70 °C (-13 °F to +158 °F)
	Operating temperature	+5 °C to +55 °C (+41 °F to +131 °F)

OSI/OSI-D with OMM-2C system used in single probe mode

The system can be used with any Renishaw OMP, OLP or OTS probe system. The following descriptions use OMP60 as an example.

In single probe mode, the system will interface a single Renishaw machine probe with the machine controller. It is possible for either a single OMM-2C or tandem OMM-2C/OMM-2 to be connected to the OSI. The selected configuration will depend on the machine application.

When the OMM-2C is used in tandem, both receivers will simultaneously provide an indication of system status. Tandem OMM-2C can be used on twin-spindle machines to maintain probe communications when a probe is in the second spindle. Tandem OMM-2C and OMM-2 allows for uninterrupted probe communications where line-of-sight issues become apparent when only a single receiver is used.

The illustration below shows a typical OSI with OMM-2C system used in single probe mode. Alternatively, the system can be used to interface a single OTS (optical tool setter) instead of the OMP (optical machine probe) shown.

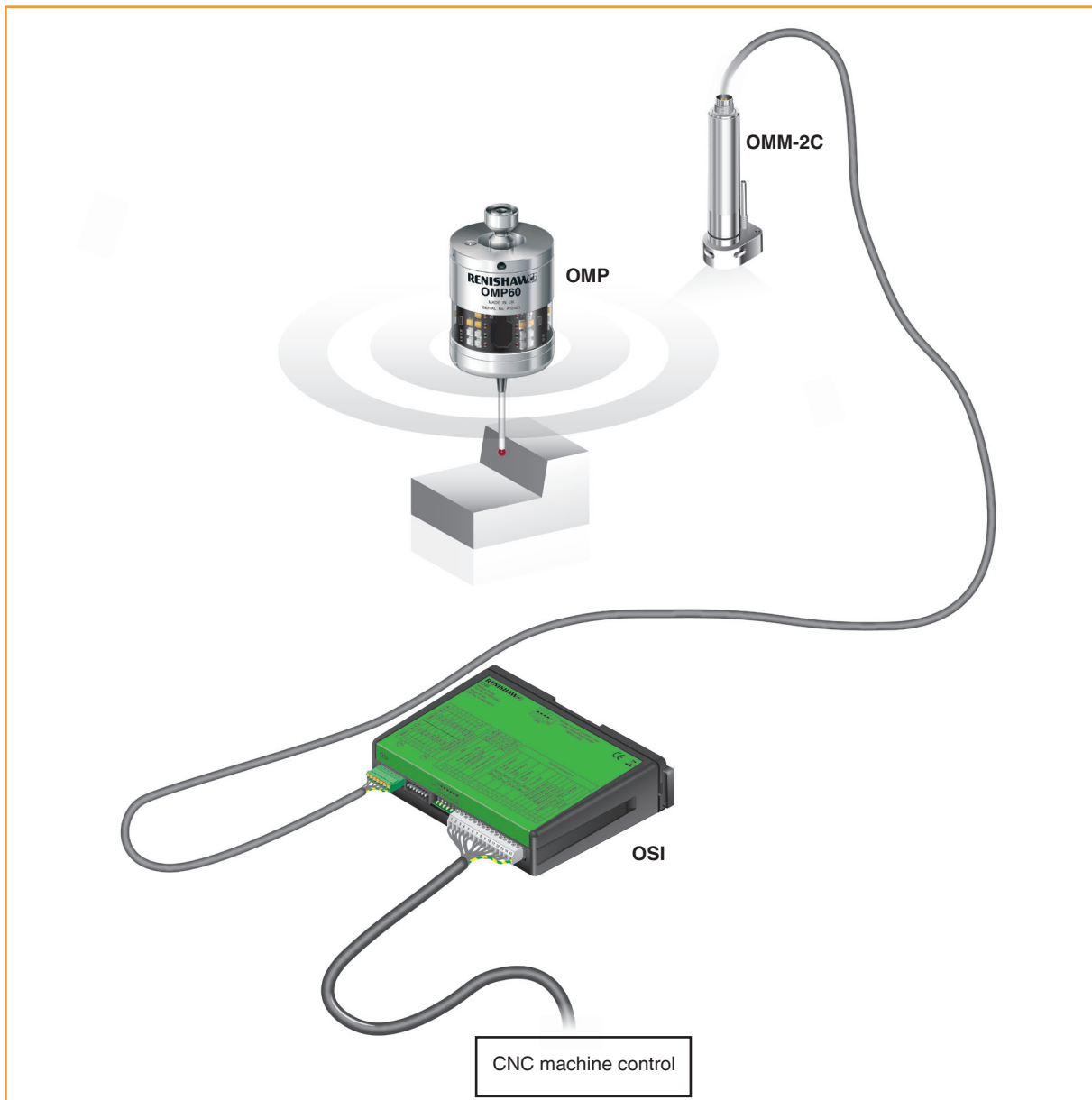

OSI/OSI-D with OMM-2C system used in multiple probe mode

In multiple probe mode, the system will sequentially interface up to three separate Renishaw optical machine probes with the machine controller. It is possible to have either a single OMM-2C or a tandem OMM-2C or OMM-2 configuration to best suit the application.

Application of the system in multiple probe mode is suited to many machine applications. Typical examples are as follows:

1 × OMP with 2 × OTS (optical tool setter) (illustrated below).

This arrangement is suitable for a machine application that has a partitioned machining area with an OTS positioned in each area. An OMP in the spindle is used in both areas. The OMP is assigned as Probe 1 and the 2 × OTS assigned as Probe 2 and Probe 3.

2 × OMP with 1 × OTS

This arrangement is suitable for a machine application that requires two different stylus configurations. The 2 × OMP are assigned as Probe 1 and Probe 2 and the OTS is assigned as Probe 3.

3 × OTS

This arrangement is suitable for a pallet loaded machine application with an OTS installed on three pallets, each communicating with an OMM-2C in the machine. The 3 × OTS are assigned as Probe 1, Probe 2 and Probe 3.

3 × OMP

This arrangement is suitable for a machine application which requires three different stylus or probe configurations; for example, 2 × strain gauge probes and 1 × modular probe. For this configuration to be compatible, one probe should have Probe 3 functionality.



This page is intentionally left blank.

System installation

Typical OMM-2C system installation

Introduction

WARNING: Ensure the machine tool is in a safe condition and power is removed before removing covers. Only qualified persons should adjust switches.

The OMM-2C should be mounted as near to the machine spindle as possible (as shown below).

When mounting the OMM-2C, it is important that the sealing ring forms a tight seal around the rim of the bore into which the body of the OMM-2C is to be located.

CAUTION: Make sure the sealing ring and air fitting screw (if applicable) are clean and lubricated prior to being mounted in the machine spindle.

NOTE: Do not overtighten the mounting screw. Maximum torque is 1.5 Nm (1.11 lbf.ft.).

Single configuration

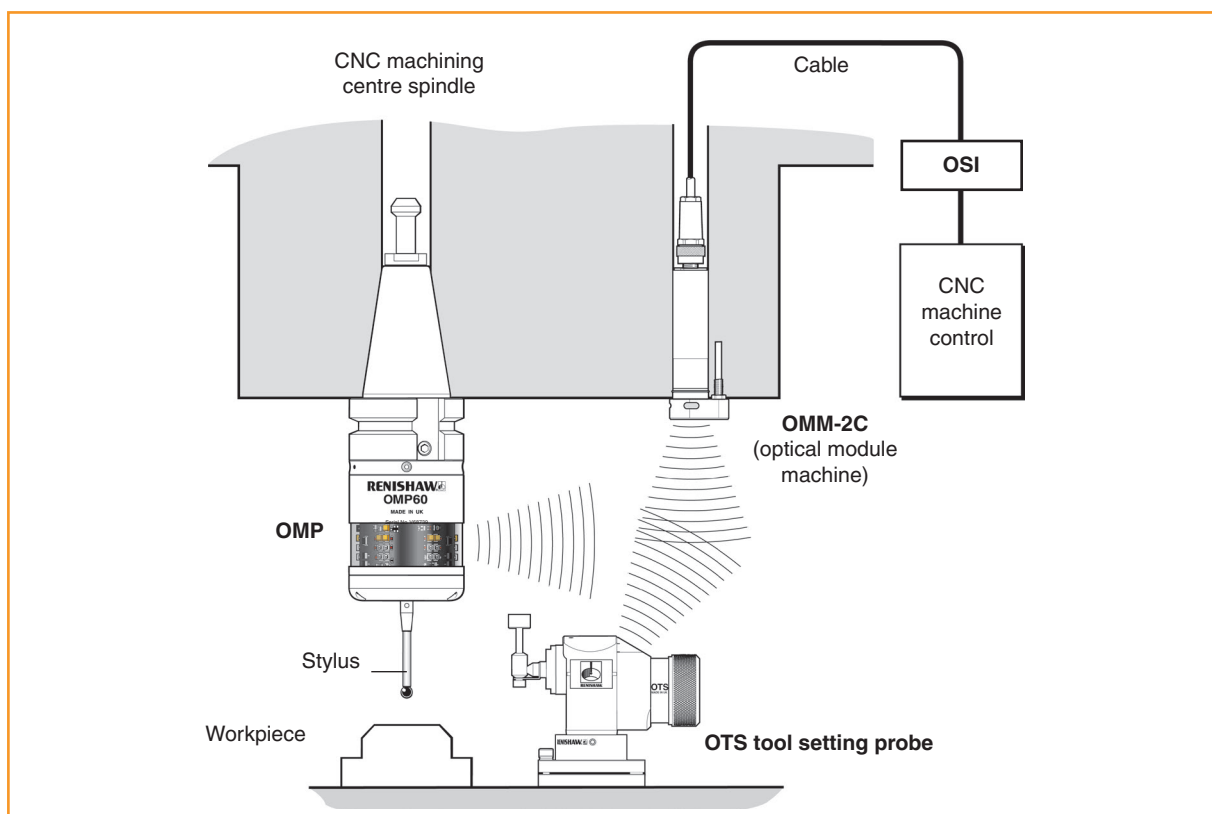

OMM-2C application

OSI

A single, tandem or combination of OMM-2C and OMM-2 configuration can be connected to the OSI. Each OMM-2 / OMM-2C is connected to the interface by a 7-way connector block (as shown in the wiring diagram on page 3.8).

OSI-D

One OMM-2C is connected to connector 'A' of the interface using a 15-way HD D type connector. The second OMM-2C is connected to connector 'B' of the interface using a 7-way connector block (as shown in the wiring diagram on page 3.8).

A single OMM-2 can be connected to the OSI-D using a 7-way connector block (as shown in the wiring diagram on page 3.8).

When a tandem OMM-2 / OMM-2C configuration is used, there will be a simultaneous indication of system status on both receivers (for OMM-2C, see Chapter 2, "OMM-2C basics", or for OMM-2 see the *OSI with OMM-2 multiple optical probe interface system* installation guide (Renishaw part no. H-5492-8504).

Tandem OMM-2C can be used in machines with two separate spindles. It is not necessary to shield one receiver from the other, and operating envelopes can overlap.

OMM-2C cable

Cable termination

Suitable ferrules should be crimped onto each cable wire for a more positive connection at the terminal box.

Standard cable variants

The OMM-2C standard polyurethane cables are supplied in 8 m (26 ft) and 15 m (49 ft) lengths. Please contact Renishaw for other cable lengths if required.

NOTE: The maximum permissible length of cable is 30 m (98 ft).

Cable specification

Ø4.75 mm (0.19 in), 12 core, screened cable, each core consisting of 7 × 0.1 mm wires.

Cable sealing

Coolant and dirt are prevented from entering the OMM-2C by the cable connector. The OMM-2C cable can be protected against physical damage by fitting flexible conduit if required.

NOTE: Do not overtighten cable connector. Maximum torque is 2 Nm (1.48 lbf.ft.).

Mounting the OSI/OSI-D to a DIN rail

NOTE: Lift spring end plate to attach OSI to DIN rail.

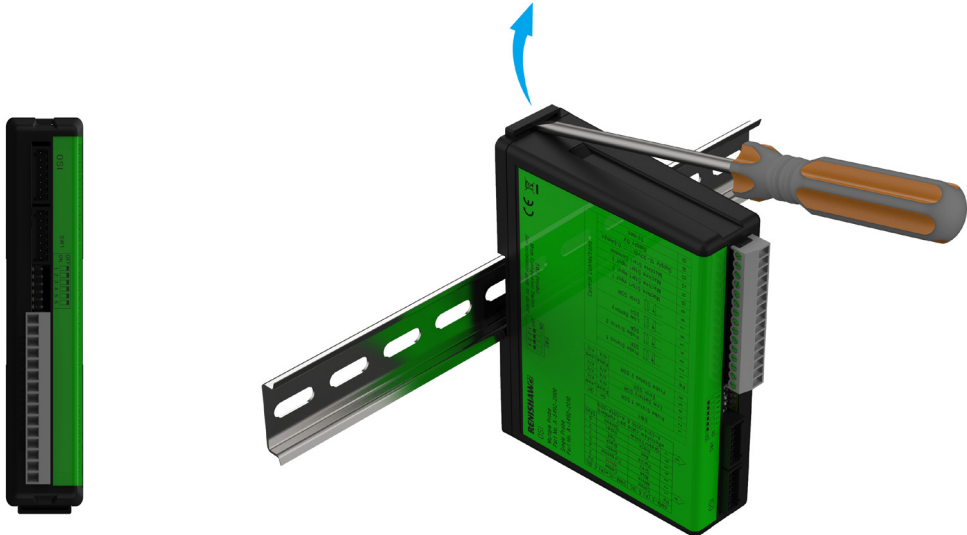

Standard DIN rail mounting

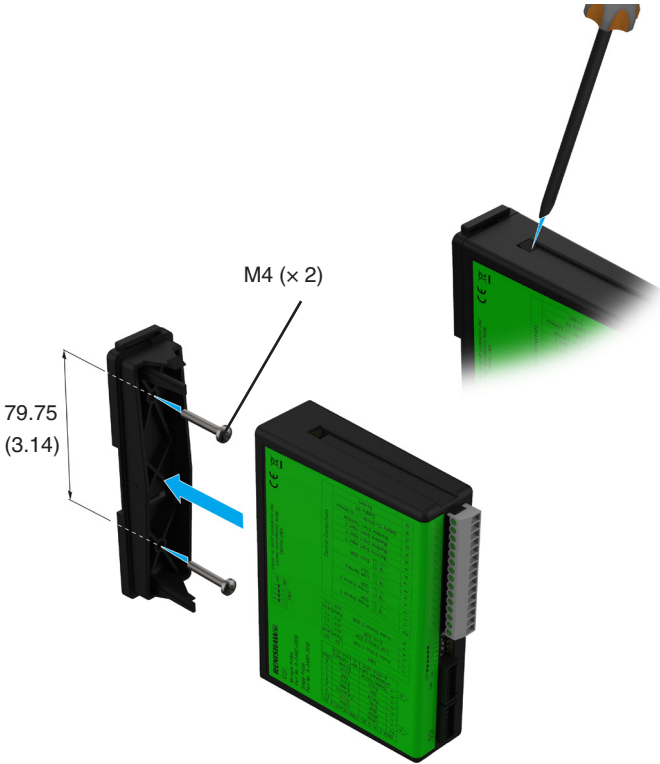

Alternative mounting

Dimensions mm (in)

Performance envelope of OMM-2C with OMP600 or OMP60

Reflective surfaces within the machine cabinet may increase the signal transmission range.

Coolant residue accumulating on the windows of the OMM-2C and OMP will have a detrimental effect on transmission performance. Wipe the windows clean as often as necessary to maintain unrestricted transmission.

For best system performance, ensure the OMM-2C is mounted in a position which is not directly in front of a light source.

The probe and OMM-2C may deviate from the optical centre line, provided opposing light cones always overlap, with transmitters and receivers in the other's field of view (eye-to-eye).

In multiple probe mode applications, OMP600 or OMP60 may be configured as Probe 1, Probe 2 or Probe 3.

CAUTION: If two systems are operating in close proximity, take care to ensure that the signals transmitted from the OMP on one machine are not received by the OMM-2C on another machine and vice versa.

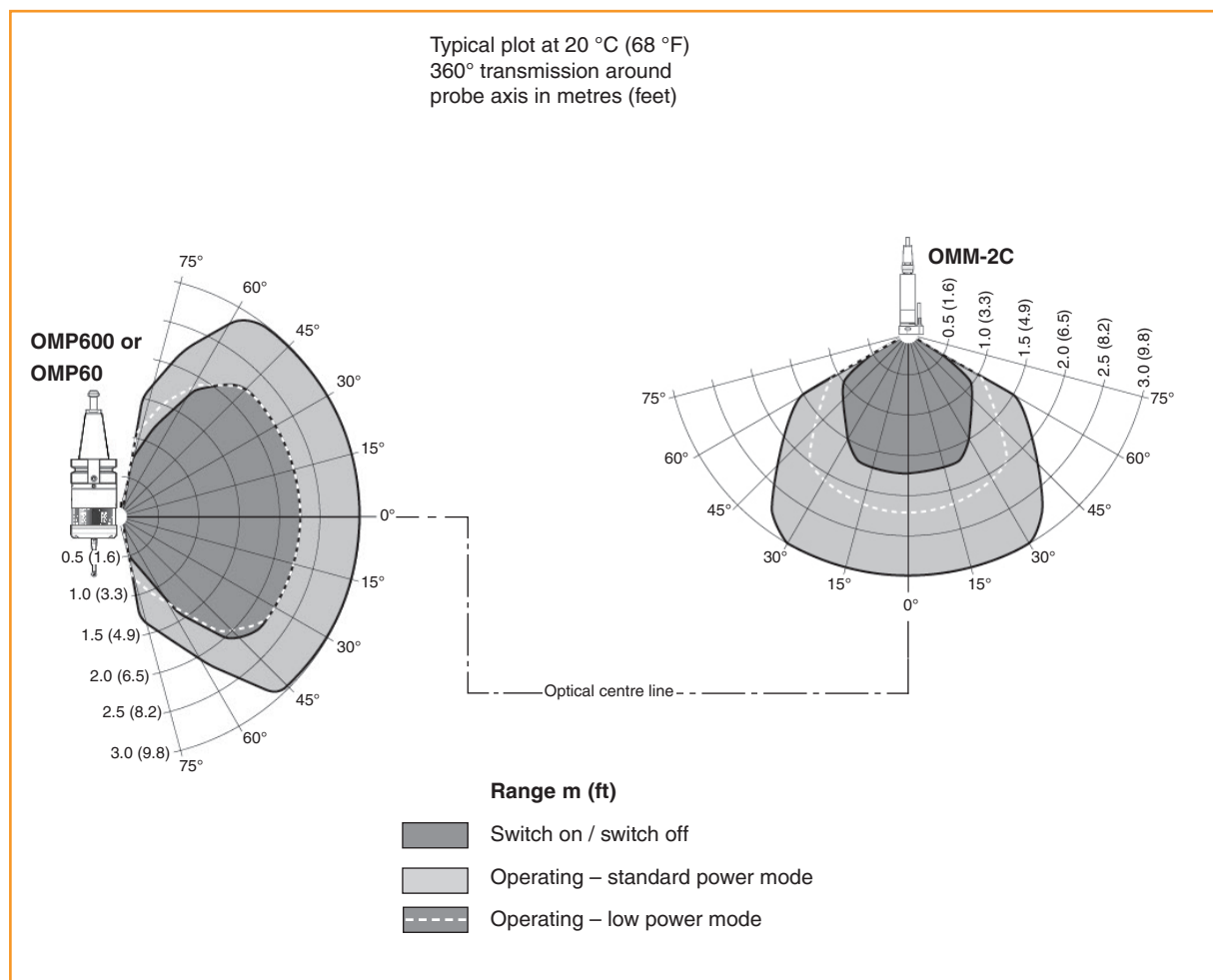

Performance envelope of OMM-2C with OMP400, OMP40-2 or OLP40

Reflective surfaces within the machine cabinet may increase the signal transmission range.

Coolant residue accumulating on the windows of the OMM-2C and OMP will have a detrimental effect on transmission performance. Wipe the windows clean as often as necessary to maintain unrestricted transmission.

For best system performance, ensure the OMM-2C is mounted in a position which is not directly in front of a light source.

The probe and OMM-2C may deviate from the optical centre line, provided opposing light cones always overlap, with transmitters and receivers in the other's field of view (eye-to-eye).

In multiple probe mode applications, OMP400 may be configured as Probe 1 or Probe 2 and OMP40 or OLP40 may be configured as Probe 1, Probe 2 or Probe 3.

CAUTION: If two systems are operating in close proximity, take care to ensure that the signals transmitted from the OMP on one machine are not received by the OMM-2C on another machine and vice versa.

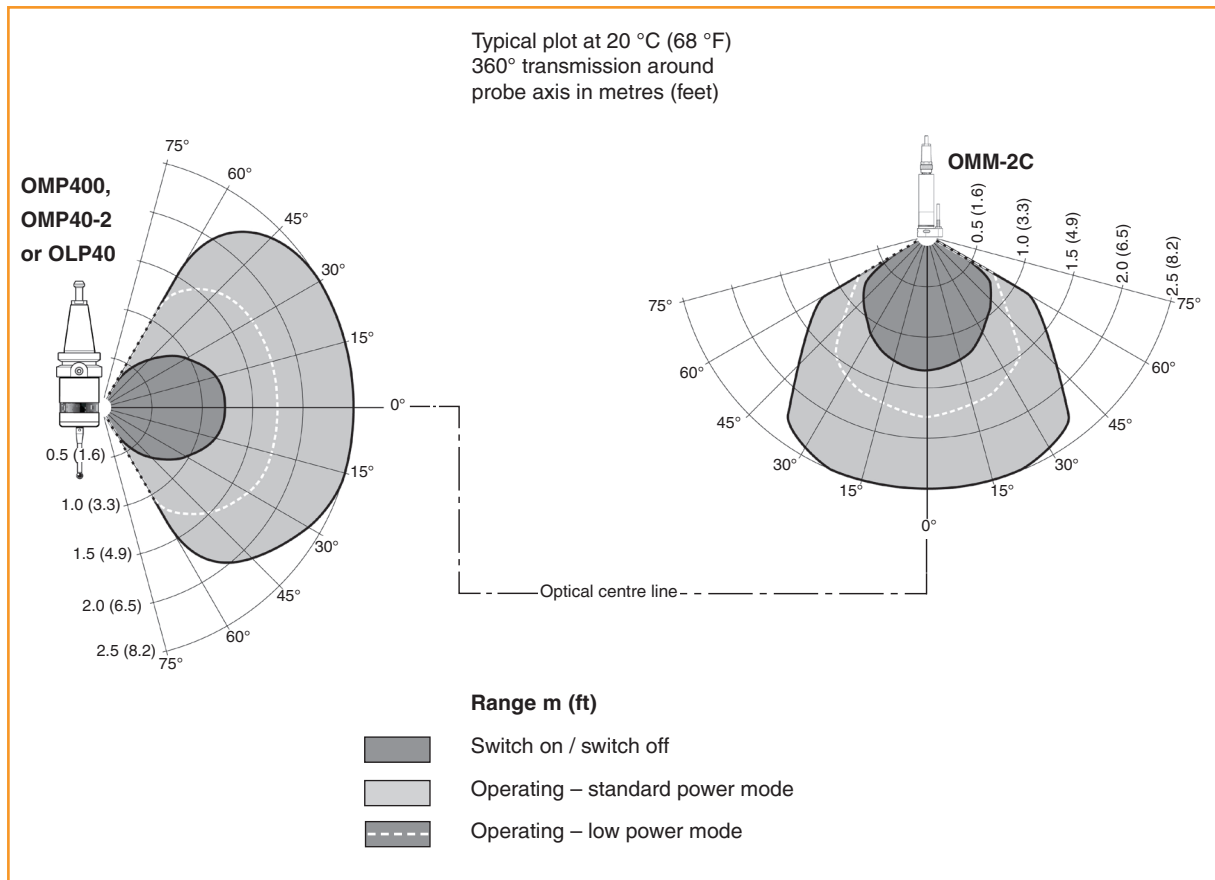

Performance envelope of OMM-2C with OTS

Reflective surfaces within the machine cabinet may increase the signal transmission range.

Coolant residue accumulating on the windows of the OMM-2C and OTS will have a detrimental effect on transmission performance. Wipe the windows clean as often as necessary to maintain unrestricted transmission.

For best system performance, ensure the OMM-2C is mounted in a position which is not directly in front of a light source.

The probe system should be positioned so that the signal transmission is maintained when the OTS is positioned below the machine spindle.

The OTS and OMM-2C may deviate from the optical centre line, provided opposing light cones always overlap, with transmitters and receivers in the other's field of view (eye-to-eye).

In multiple probe mode applications, OTS may be configured as Probe 1, Probe 2 or Probe 3.

CAUTION: If two systems are operating in close proximity, take care to ensure that the signals transmitted from the OTS on one machine are not received by the OMM-2C on another machine and vice versa.

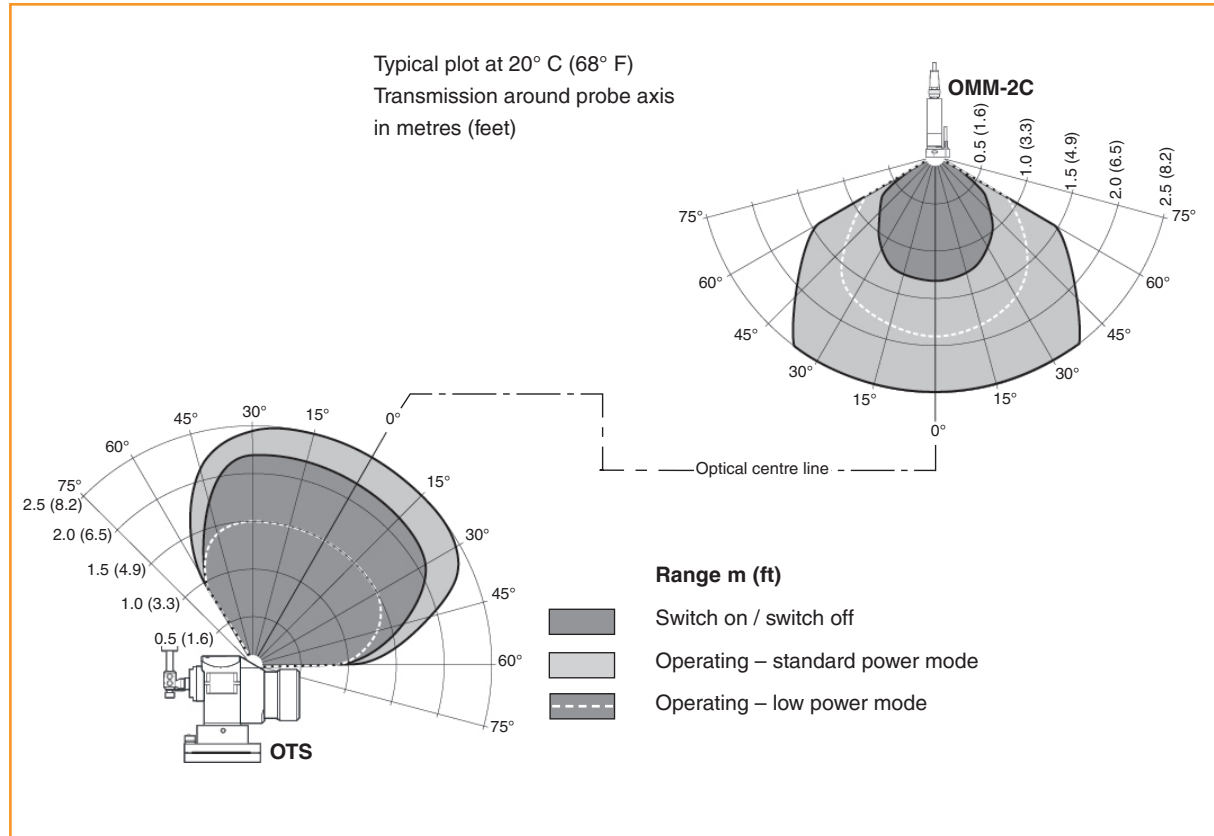

Wiring diagram (with output groupings shown)

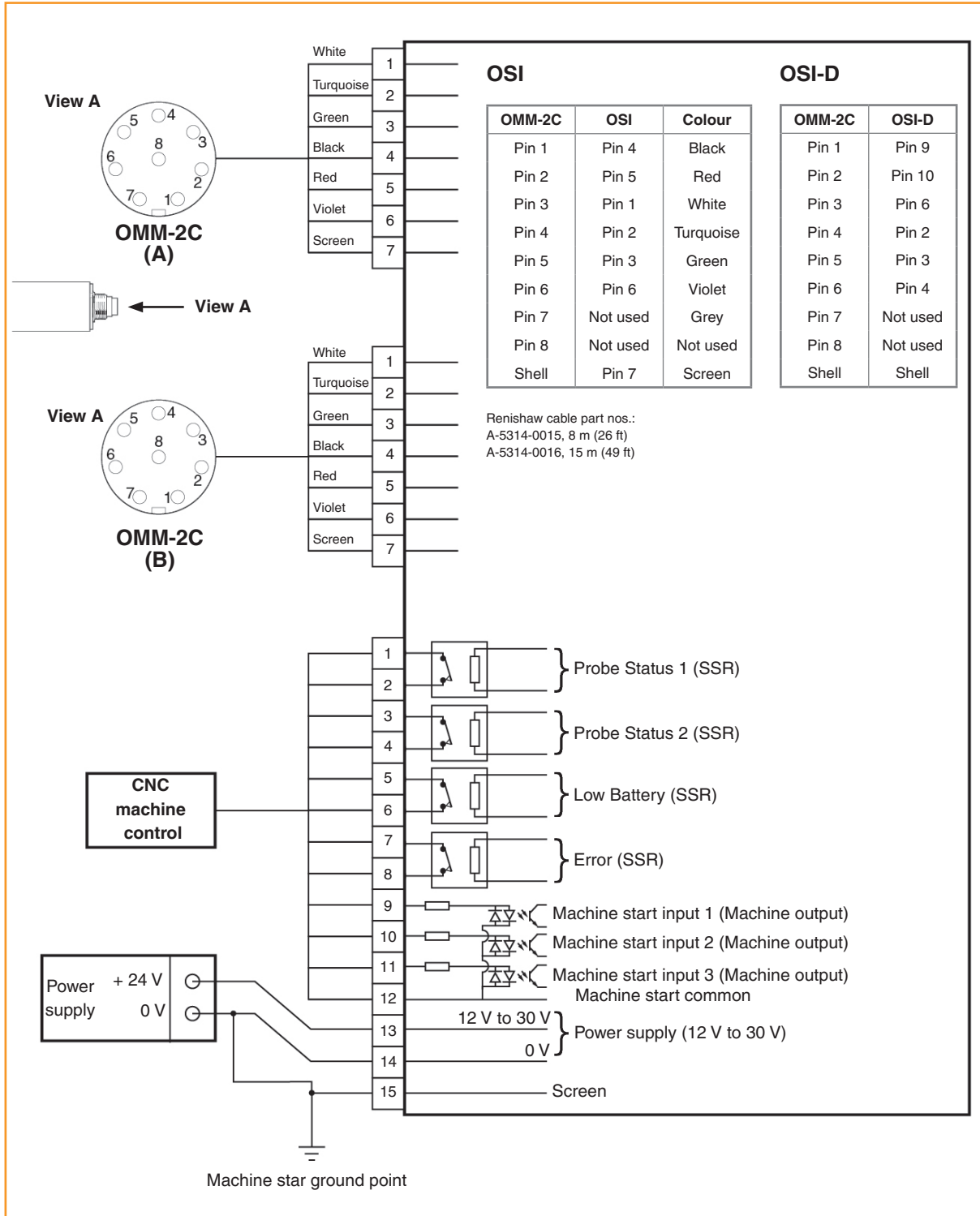

CAUTIONS:

The power supply 0 V should be terminated at the machine ground (“star point”). If a negative supply is used, then the negative output must be fused.

The dc supply to this equipment must be derived from a source which is approved to BS EN IEC 62368-1.

Integral airblast installation (optional)

Integral airblast application

The OMM-2C is available with an integral optional airblast facility. An air supply is connected to the OMM-2C through the special mounting screw and the air feed is internally routed to air nozzles around the OMM-2C front window which assists with keeping the optical window clear of swarf and debris.

It is recommended that a switched air supply is used prior to any probing routine and the air supply to the OMM-2C is switched off after the probing routine has finished.

Connecting and purging the air supply

CAUTIONS:

Do not connect the OMM-2C system to an oiled air supply. Purge all piping prior to connection.

Safety glasses must be worn.

1. Locate a source of clean air that conforms to BS ISO 8573-1: Air quality of class 5.9.4.
2. Connect a suitable pipe to the air supply.

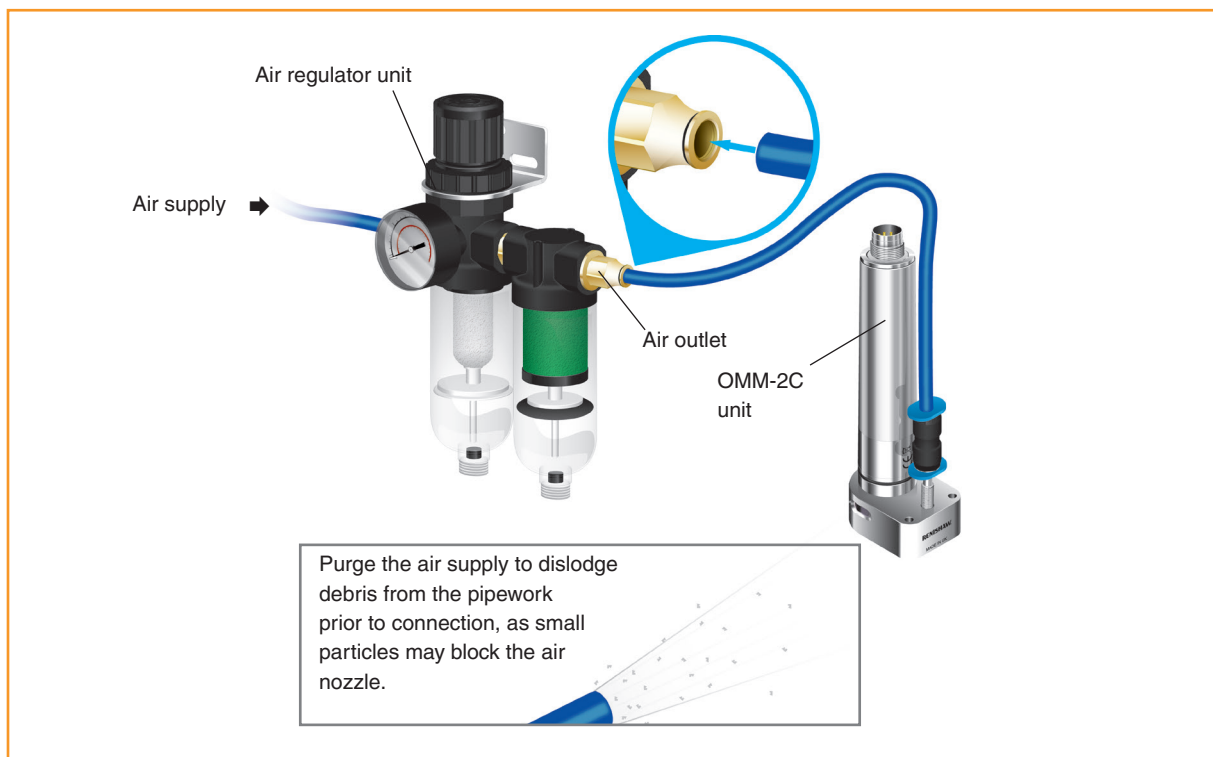

3. Before connecting the pipe to the inlet of the air regulator unit, briefly switch on the air supply to clear out all debris from the pipe.
4. Connect one end of the $\text{\O}4$ mm air pipe into the air regulator unit.
5. Cut the $\text{\O}4$ mm pipe to length, ensuring that the length of the pipe is as short as possible to minimise the drop in air pressure.
6. Temporarily tape over the free end of the pipe to ensure that no coolant or debris is able to enter it.

7. Push the free end of the air supply pipe through the air pipe spring conduit.
8. Remove the tape from the end of the air pipe. Before connecting the pipe to the inlet of the OMM-2C unit, briefly switch on the air supply to clear out any debris from the pipe.
9. Connect the free end of the pipe to the OMM-2C unit using a 4 mm to 3 mm air fitting.

NOTE: The integral airblast facility should not be used as a replacement for routine maintenance checks or relied on to ensure the optical window is kept clean of debris and swarf.

Maintenance

4.1

Maintenance

You may undertake the maintenance routines described in these instructions.

Further dismantling and repair of Renishaw equipment is a highly specialised operation, which must be carried out at authorised Renishaw Service Centres.

Equipment requiring repair, overhaul or attention under warranty should be returned to your supplier.

Cleaning the interface

Wipe the window of the interface with a clean cloth to remove machining residue. This should be done on a regular basis to maintain optimum transmission.

CAUTION: The OMM-2C has a glass window. Handle with care if broken to avoid injury.



Removing the OMM-2C

WARNING: Ensure the machine tool is in a safe condition and power is removed before removing covers. Only qualified persons should work on a machine tool.

In the event that you need to remove the OMM-2C, the receiver incorporates a jacking thread to aid removal.

1. Purge machine air supply (if air blast fitted) and remove power from the OSI.
2. Clean the OMM-2C prior to disassembly to ensure no debris enters the unit.
3. Disconnect air pipe from the OMM-2C and remove cap from both ends (if applicable)
4. Unscrew cable connector from rear of the OMM-2C and secure.
5. Carefully remove mounting screw/air feed screw from OMM-2C ensuring 'O' rings are kept clean.
6. Insert an M5 screw (not supplied) into the threaded mounting hole.
7. Tighten the screw to lift the OMM-2C out of the machine spindle bore. When clear of the spindle, remove the screw completely and refit the original mounting screw / airscrew to prevent debris entering air chamber.

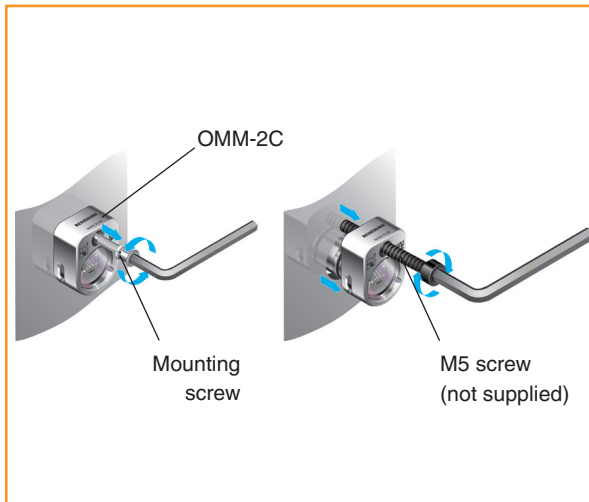

Maintenance – air regulator unit

The procedures described in this section apply only to the air regulator system (A-2253-5120) that is available from Renishaw plc.

Checking the liquid level

Regularly check the level of the accumulated liquid in each of the filter bowls. It is important that the level is kept below the filter element.



Draining the liquid

Drain the liquid that has accumulated in the filter bowls as follows:

1. Make a note of the air supply pressure, then switch off the air supply. A quantity of liquid will drain from the bowls.
2. Switch on the air supply and set the pressure to the value noted in step 1.
3. Repeat steps 1 and 2 until the bowls are empty.

Removing and refitting filter elements

Regularly inspect the filter element in each filter bowl. They should be replaced when dirty or wet and at least once each year. For each filter bowl, do this as follows:

1. Make a note of the air supply pressure, then switch off the air supply.
2. Unscrew the filter bowl by hand (see the figure on page 4-4).
3. Remove the O-ring from the recess in the filter bowl. Discard the O-ring.
4. Unscrew and remove the filter element.
5. Fit the replacement filter and, where applicable, the O-ring. These are shown in dotted box A in the figure on page 4.4.
6. Fit a new O-ring into the recess in the filter bowl.
7. Refit the filter bowl and screw hand tight.
8. Switch on the air supply and set the pressure to the value noted in step 1.

Replacing other service kit components

1. Make a note of the air supply pressure, then switch off the air supply.
2. Using a 38 mm AF spanner, remove the regulator head.
3. Remove the components (shown in dotted box B in the figure on the page 4.4) from the body of the regulator.
4. Fit the new components to the regulator body.
5. Refit the regulator head and tighten to 7.7 Nm (5.7 lbf.ft).
6. Switch on the air supply and set the pressure to the value noted in step 1.

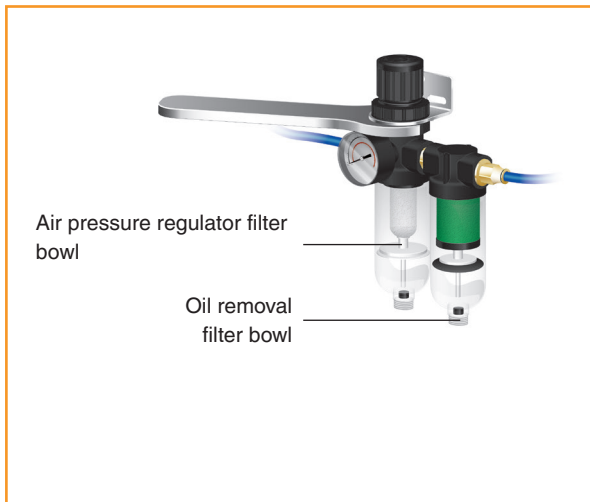

NOTE: Items shown within dotted boxes A and B are included in the air filter service kit obtainable from Renishaw (see the Parts lists on page 6.1).

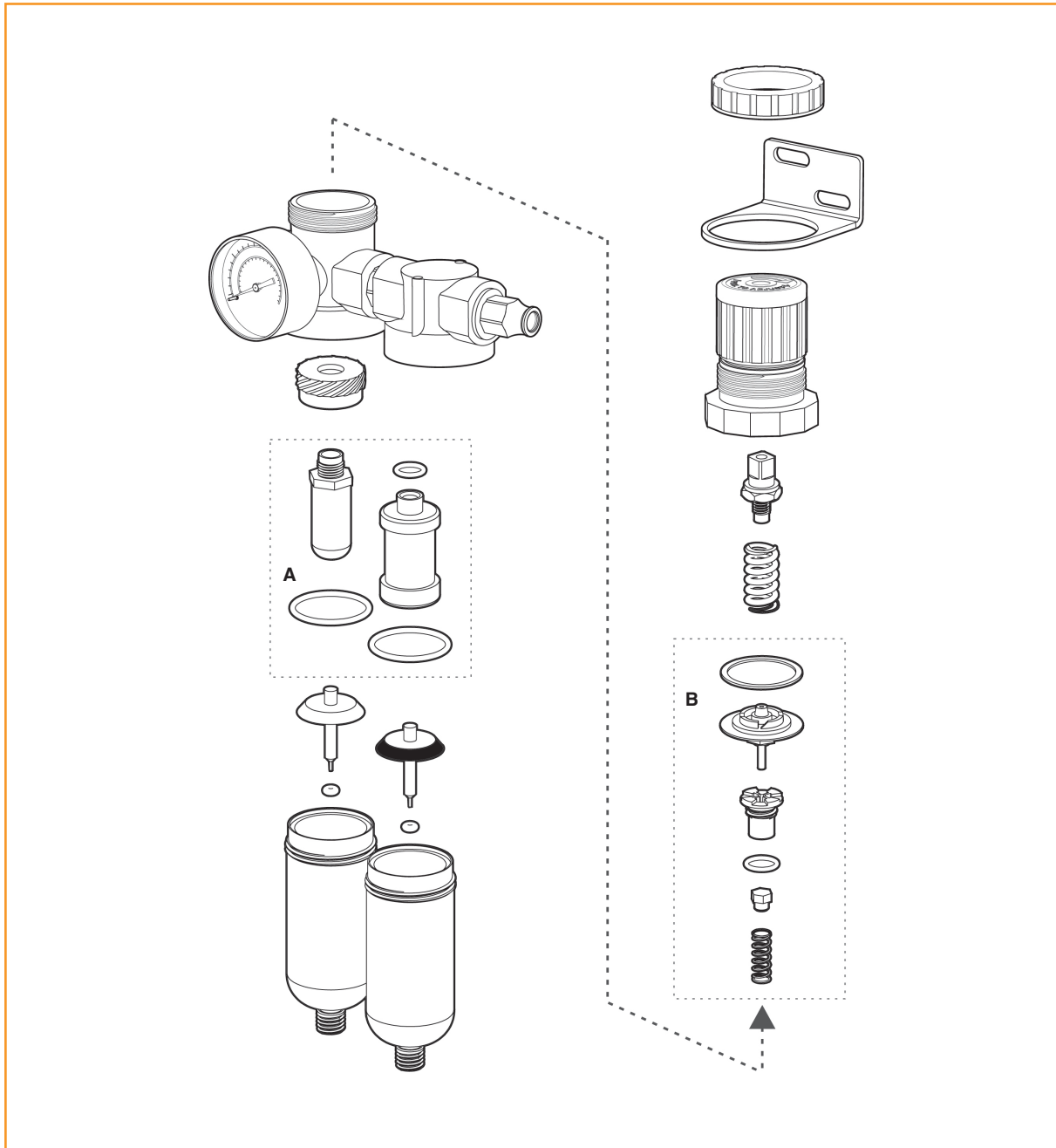

This page is intentionally left blank.

Fault-finding

Symptom	Cause	Action
Probe fails to switch on or switch off.	Installation / CNC program fault.	Correct M-code and/or wiring from machine to OSI and from OSI to OMM-2C and/or CNC program.
	OMM-2C flashes blue, yellow, violet and cyan due to ambiguous start information being received.	Correct M-codes in CNC program when two are used. To reset the error, deactivate all active machine start inputs. Select 50 ms or 100 ms delay.
	The probe is out of the start range.	Change the CNC program to bring the probe within the start range of the receiver.
	The transmission beam is obstructed.	Clean the receiver window and remove any obstructions.
	Incompatible probe / probe transmission setting.	Ensure the probe switch-on / switch-off method is set to optical on / optical off. Change the probe or probe setting to modulated and appropriate start code.
	Incorrect Machine Start setting.	Reconfigure the Machine Start setting switch SW2.
	Dead probe batteries.	Replace the probe batteries.
	Optical interference is blocking the start signal.	Remove the source of interference and ensure that interfering light does not shine onto the receiver window or probe window.

Symptom	Cause	Action
Probe 2 or Probe 3 fails to switch on.	OSI in single probe mode.	Change OSI to multiple probe mode.
	A time delay exists between machine inputs from the controller.	Increase selected time delay.
The probe stops in mid-cycle. or An unexpected error occurs during a probing cycle. or An unexpected trigger occurs during the probing cycle.	The transmission beam is obstructed.	Remove the obstruction.
	Optical interference.	Remove the source of interference and ensure that interfering light does not shine into the receiver window.
	Intermittent wiring fault.	Correct wiring.
	The probe has moved outside the reception range.	Change the CNC program to bring the probe within the reception range of the receiver.
	The probe has not been triggered for more than 90 minutes.	Restart the probe and ensure that the probe is not idle for 90 minutes.
The probe switches on, but the OMM-2C LED is lit red or white.	Interfering light source is shining directly into the receiver window.	Remove the source of interference and ensure that the interfering light does not shine into the receiver window.
	The probe is out of the reception range.	Change the CNC program to move the probe into the reception range of the receiver.
	A signal is being received from a probe on an adjacent machine tool.	Change the adjacent probe to low power mode.
	Installation / CNC program fault.	Check wiring and CNC program.

Symptom	Cause	Action
The probe indicates low battery condition, but the machine control does not.	Installation / CNC program fault. Machine may not have the facility integrated.	Correct low battery SSR wiring and/or CNC program.
The machine control does not respond to the probe being triggered or seated.	Probe is not switched on.	Attempt to switch it on.
	Probe is out of range.	Change the CNC program to bring the probe within the reception range.
	Installation / CNC program fault.	Correct M-code and/or wiring from machine to OSI and from OSI to OMM-2C and/or CNC program.
	A signal is being received from a probe on an adjacent machine tool.	Change the adjacent probe to low power mode.
Probe triggers but the OMM-2C does not respond.	The OMP400 or OMP600 has the 3 second switch-on delay selected.	Reconfigure the OMP400 or OMP600 to the standard switch-on delay.
	The probe is out of range.	Review the performance envelopes.
	The transmission beam is obstructed.	Check that the probe and receiver windows are clean, and remove any obstruction.
	The probe is set to legacy transmission.	Reconfigure to modulated transmission.
No air from airblast.	No air to OMM-2C.	Check air supply to OMM-2C and rectify.
	CNC program fault.	Correct CNC program.
	Air supply pipe damaged or kinked.	Check air supply pipe.
	Air blast blocked.	Unblock air blast.

This page is intentionally left blank.

Parts list

Item	Part number	Description
OSI interface	A-5492-2000	OSI (multiple probe mode) with DIN rail mounting, terminal block and product support card.
OSI interface	A-5492-2010	OSI (single probe mode) with DIN rail mounting, terminal block and product support card.
OSI-D interface	A-5492-3000	OSI-D (multiple probe mode) with DIN rail mounting, terminal block and product support card.
OSI-D interface	A-5492-3010	OSI-D (single probe mode) with DIN rail mounting, terminal block and product support card.
OMM-2C (standard non-airblast)	A-5991-0001	OMM-2C (non-integrated airblast) with 7-way socket and product support card.
OMM-2C (optional airblast)	A-5991-0005	OMM-2C (integrated airblast) with 7-way socket and product support card.
OSI terminal block (15-way)	P-CN25-0009	15-way socket terminal for OSI.
OMM-2C terminal block (7-way)	P-CA79-0021	7-way socket terminal for OMM-2C.
OMM-2C cable	A-5314-0015	OMI-2C/OMM-2C cable assembly, with 8 m (26 ft) of cable (7-way connector not included).
OMM-2C cable	A-5314-0016	OMI-2C/OMM-2C cable assembly, with 15 m (49 ft) of cable (7-way connector not included).
Mounting screw (standard)	A-5991-0113	Replacement standard mounting screw. For use with A-5991-0001.
Mounting screw (air blast option)	A-5991-0112	Replacement mounting screw for the optional integral air blast OMM-2C. For use with A-5991-0005.
OSI-D cable	A-5492-0042	OSI-D 15-way HD D type connector to 15-way D type adaptor, with 3 m (9.8 ft) of cable.
OSI-D cable	A-5492-0043	OSI-D 15-way controller connector to 15 way HD D type adaptor, with 3 m (9.8 ft) of cable.
OSI-D cable	A-5492-0044	OSI-D 15-way controller connector to 15-way D type, with 3 m (9.8 ft) of cable.
OSI-D cable	A-5492-0045	OSI-D to OMM-2C extension cable 15-way HD D type connector, with 3 m (9.8 ft) of cable.
Air assembly	A-2253-5120	Filter/regulator, Ø4 mm tube × 25 m air tube, Ø4 mm tee fitting.

Item	Part number	Description
Air adaptor	M-4179-0161	Ø3 mm × 5 m air tube, Ø3 mm to Ø4 mm straight fitting blanking cap.
Nylon tube (Ø3 mm)	P-PF26-0014	Ø3 mm × 25 m air tube (coil).
Nylon tube (Ø4 mm)	P-PF26-0010	Ø4 mm × 25 m air tube (coil).
Equal tee fitting	P-PF04-0010	Ø4 mm push-fit pneumatic adaptor.
Straight fitting (Ø4 mm to Ø4 mm)	P-PE02-0020	Ø4 mm to Ø4 mm push-fit pneumatic adaptor.
Straight fitting (Ø4 mm to Ø3 mm)	P-PE02-0019	Ø4 mm to Ø3 mm push-fit pneumatic adaptor.
Pneumatic blanking cap	P-BG03-0029	Pneumatic blanking cap.
Air filter service	P-FI01-S002	Replacement filter and seals for air filter/regulator unit.
Deluxe air filter	P-FI01-0008	For filtering large quantities of contaminated air.
Publications. These can be downloaded from our website at www.renishaw.com		
OMP40-2	H-4071-8504	Installation guide: for the set up of the OMP40-2.
OLP40	H-5625-8504	Installation guide: for the set up of the OLP40.
OMP400	A-5069-8504	Installation guide: for the set up of the OMP400.
OMP60	A-4038-8505	Installation guide: for the set up of the OMP60.
OMP600	H-5180-8504	Installation guide: for the set up of the OMP600.
OTS	H-5401-8504	Installation guide: for the set up of the OTS.

NOTE: The serial number of each OMM-2C unit is found on the receiver body.

This page is intentionally left blank.

Renishaw plc
New Mills, Wotton-under-Edge
Gloucestershire, GL12 8JR
United Kingdom

T +44 (0)1453 524524
F +44 (0)1453 524901
E uk@renishaw.com
www.renishaw.com

RENISHAW 
apply innovation™

For worldwide contact details, visit
www.renishaw.com/contact