

MCUlite-2, MCU5-2 and MCU W-2 installation and user's guide

www.renishaw.com

MCUlite-2, MCU5-2 and MCU W-2 installation and user's guide

Documentation part number H-1000-5280-06-C



MCUlite-2, MCU5-2 and MCU W-2 installation and user's guide

www.renishaw.com

MCU general information

© 2016 - 2024 Renishaw plc. All rights reserved.

 ORIGINAL LANGUAGE VERSION

This document may not be copied or reproduced in whole or in part, or transferred to any other media or language by any means, without the prior written permission of Renishaw.

Disclaimer

WHILE CONSIDERABLE EFFORT WAS MADE TO VERIFY THE ACCURACY OF THIS DOCUMENT AT PUBLICATION, ALL WARRANTIES, CONDITIONS, REPRESENTATIONS AND LIABILITY, HOWSOEVER ARISING, ARE EXCLUDED TO THE EXTENT PERMITTED BY LAW.

RENISHAW RESERVES THE RIGHT TO MAKE CHANGES TO THIS DOCUMENT AND TO THE EQUIPMENT, AND/OR SOFTWARE AND THE SPECIFICATION DESCRIBED HEREIN WITHOUT OBLIGATION TO PROVIDE NOTICE OF SUCH CHANGES.

Trade marks

RENISHAW®, the probe symbol and REVO® are registered trade marks of Renishaw plc.

Renishaw product names, designations and the mark 'apply innovation' are trade marks of Renishaw plc or its subsidiaries.

Other brand, product or company names are trade marks of their respective owners.

WEEE



The use of this symbol on Renishaw products and / or accompanying documentation indicates that the product should not be mixed with general household waste upon disposal. It is the responsibility of the end user to dispose of this product at a designated collection point for waste electrical and electronic equipment (WEEE) to enable reuse or recycling. Correct disposal of this product will help to save valuable resources and prevent potential negative effects on the environment. For more information, please contact your local waste disposal service or Renishaw distributor.

Warranty

Unless you and Renishaw have agreed and signed a separate written agreement, the equipment and/or software are sold subject to the Renishaw Standard Terms and Conditions supplied with such equipment and/or software, or available on request from your local Renishaw office.

Renishaw warrants its equipment and software for a limited period (as set out in the Standard Terms and Conditions), provided that they are installed and used exactly as defined in associated Renishaw documentation. You should consult these Standard Terms and Conditions to find out the full details of your warranty.

Equipment and/or software purchased by you from a third-party supplier is subject to separate terms and conditions supplied with such equipment and/or software. You should contact your third-party supplier for details.

MCUlite-2, MCU5-2 and MCU W-2 installation and user's guide

www.renishaw.com

Care of equipment

Renishaw probes and associated systems are precision tools used for obtaining precise measurements and must therefore be treated with care.

Changes to Renishaw products

Renishaw reserves the right to improve, change or modify its hardware or software without incurring any obligations to make changes to Renishaw equipment previously sold.

Company registration details

Renishaw plc. Registered in England and Wales. Company no: 1106260. Registered office: New Mills, Wotton-under-Edge, Gloucestershire, GL12 8JR, UK.

Packaging

To aid end user recycling and disposal the materials used in the different components of the packaging are stated here:

Packaging component	Material	94/62/EC code	94/62/EC number
Outer box	Corrugated fibreboard	PAP	20
Packaging insert	Corrugated fibreboard	PAP	20
Packing foam	Low density polyethylene	LDPE	4
Bag	Low density polyethylene	LDPE	4

MCUlite-2, MCU5-2 and MCU W-2 installation and user's guide

www.renishaw.com

MCU product compliance

EU declaration of conformity

Contact Renishaw plc or visit www.renishaw.com/EUCMM for the full EU declaration.

UK declaration of conformity

Contact Renishaw plc or visit www.renishaw.com/UKCMM for the full UK declaration.

EMC conformity

This equipment must be installed and used in accordance with this installation guide. This product is intended for industrial use only and should not be used in a residential area or connected to a low voltage power supply network which supplies buildings used for residential purposes.

FCC (USA only)

Information to user (47 CFR 15.105)

This equipment has been tested and found to comply with the limits for a Class A digital device, pursuant to Part 15 of the FCC rules. These limits are designed to provide reasonable protection against harmful interference when the equipment is operated in a commercial environment. This equipment generates, uses, and can radiate radio frequency energy and, if not installed and used in accordance with the instruction manual, may cause harmful interference to radio communications. Operation of this equipment in a residential area is likely to cause harmful interference, in which case you will be required to correct the interference at your own expense.

Information to user (47 CFR 15.21)

The user is cautioned that any changes or modifications not expressly approved by Renishaw plc or authorised representative could void the user's authority to operate the equipment.

Equipment label (47 CFR 15.19)

This device complies with part 15 of the FCC Rules. Operation is subject to the following two conditions:

1. This device may not cause harmful interference.
2. This device must accept any interference received, including interference that may cause undesired operation.

MCUlite-2, MCU5-2 and MCU W-2 installation and user's guide

www.renishaw.com

Supplier's declaration of conformity (47 CFR Section 2.1077 Compliance information)

Unique identifier: MCUlite-2, MCU5-2

Responsible party - US contact information

Renishaw Inc.
1001 Wesemann Drive
West Dundee
Illinois
IL 60118
United States

Telephone number: +1 847 286 9953

Email: usa@renishaw.com

ICES-003 (Canada only)

Class A Equipment Statement (non-residential)

CAN ICES-003(A) / NMB-003(A)

MCUlite-2, MCU5-2 and MCU W-2 installation and user's guide

www.renishaw.com

Radio type approvals for MCU W-2

Country name	Logo	Identification
Brazil	No logo applicable	ID : ANATEL: 08263-24-02812 (Joystick) ID : ANATEL: 08326-24-02812 (Cradle) Este equipamento no tem direito proteo contra interferencia prejudicial e no pode causar interferencia em sistemas devidamente autorizados.
Canada	No logo applicable	IC: 1931B-BISMII This device complies with Industry Canada's license-exempt RSSs. Operation is subject to the following two conditions: 1. This device may not cause interference; and 2. This device must accept any interference, including interference that may cause undesired operation of the device. Le présent appareil est conforme aux CNR d'Industrie Canada applicables aux appareils radio exempts de licence. L'exploitation est autorisée aux deux conditions suivantes: 1. l'appareil ne doit pas produire de brouillage; 2. l'utilisateur de l'appareil doit accepter tout brouillage radioélectrique subi, même si le brouillage est susceptible d'en compromettre le fonctionnement.
EU Inc Turkey		No ID required
India	No logo applicable	Joystick (A-5734-0200) : ETA-SD-20230807127 Cradle (A-5734-0300) : ETA-SD-20230807124 Joystick (A-5734-0850) : ETA-SD-20230807891 Cradle (A-5734-0800) : ETA-SD-20230807890 Joystick (A-5734-0700) : ETA-SD-20230807865 Cradle (A-5734-0750) : ETA-SD-20230807884
Japan	No logo applicable	MIC : 201 05215155
Mexico		Certificado No.:ANC2301C00014363 La operacin de este equipo est sujeta a las siguientes dos condiciones: (1) es posible que este equipo o dispositivo no cause interferencia perjudicial y (2) este equipo o dispositivo debe aceptar cualquier interferencia, incluyendo la que pueda causar su operacin no deseada.
Singapore		No ID Required
Taiwan		NCC ID – CCAL24LP0450T6 (Joystick) NCC ID – CCAL24LP0440T3 (Cradle) 取得審驗證明之低功率射頻器材，非經核准，公司、商號或使用者均不得擅自變更頻率、加大功率或變更原設計之特性及功能。低功率射頻器材之使用不得影響飛航安全及干擾合法通信；經發現有干擾現象時，應立即停用，並改善至無干擾時方得繼續使用。前述合法通信，指依電信管理法規定作業之無線電通信。低功率射頻器材須忍受合法通信或工業、科學及醫療用電波輻射性電機設備之干擾。

MCUlite-2, MCU5-2 and MCU W-2 installation and user's guide

www.renishaw.com

Country name	Logo	Identification
UK		No ID required
USA		FCC ID: P1403B

Exempt:

- Thailand
- Israel

REACH regulation

Information required by Article 33(1) of Regulation (EC) No. 1907/2006 ("REACH") relating to products containing substances of very high concern (SVHCs) is available at:

www.renishaw.com/REACH

China RoHS

Contact Renishaw plc or visit www.renishaw.com/ChinaRoHSCMM for the full China RoHS tabulation.



MCUlite-2, MCU5-2 and MCU W-2 installation and user's guide

www.renishaw.com

MCU safety



CAUTION: Before unpacking and installing the MCU system, the user should carefully read the safety instructions below and ensure that they are followed at all times by all operators. Operators must be trained in the use and application of the MCU system and accompanying products, in the context of the machine it is fitted to, before being allowed to operate that machine.

Please ensure that you understand all safety instructions. Familiarisation with the MCU system components is recommended.

- The CMM should only be controlled from pre-determined zones or locations
- The communication cable between the UCC controller and the MCU W-2 cradle should be routed so to avoid a trip hazard
- Do not put more than one MCU W-2 into pairing mode simultaneously
- For safety reasons it is recommended that the joystick docking station is mounted outside the CMM working area

Operation and maintenance

If the equipment is used in a manner not specified by the manufacturer, any protection provided by the equipment may be impaired

- Do not position the MCU W-2 cradle in such a position that it would be difficult to operate the E-STOP
- These products are only to be used with the appropriate Renishaw controller
- Installation of the MCU must be performed by trained personnel
- Do not edit any of the system files directly, only trained personnel may use the appropriate commissioning software package
- Remove the power before performing any maintenance operations
- Maintenance is restricted to procedures described in the maintenance section

STOP buttons

The MCU system offers three STOP buttons:

- Emergency STOP switch - RED
- STOP switch - YELLOW or GREY
- Keypad STOP button (MCU5-2 and MCU W-2)

MCUlite-2, MCU5-2 and MCU W-2 installation and user's guide

www.renishaw.com

MCU W-2 battery

This product is supplied with rechargeable lithium ion batteries. Refer to the battery manufacturer's literature for specific battery operating, safety and disposal guidelines.

- Use only the MCU W-2 cradle to recharge the batteries
- Replace the batteries only with the specified type
- Ensure that all batteries are always inserted with the correct polarity in accordance with the instructions in this manual and indicated on the product
- Do not store the batteries in direct sunlight
- Do not expose the batteries to water
- Do not expose the batteries to heat or dispose of the batteries in a fire
- Avoid forced discharge of the batteries
- Do not short circuit the batteries
- Do not disassemble, apply excessive pressure, pierce, deform or subject the batteries to impact
- Do not swallow the batteries
- Keep the batteries out of the reach of children
- If the batteries are swollen or damaged do not use them in the product and exercise caution when handling them
- Dispose of waste batteries in accordance with your local environmental and safety laws

Ensure that you comply with international and national battery transport regulations when transporting batteries or this product with the batteries inserted. Lithium ion batteries are classified as dangerous goods for transportation and require labelling and packaging in accordance with the dangerous goods regulations before being offered for transportation. To reduce the risk of shipment delays, should you need to return this product to Renishaw for any reason, do not return any batteries.

MCUlite-2, MCU5-2 and MCU W-2 installation and user's guide

www.renishaw.com

MCU warnings

Beware of unexpected movement of the CMM or probe system. The user should remain outside of the full working envelope of probe head and stylus. The machine supplier should ensure the user is aware of the full working envelope of the system.

In all applications involving the use of machine tools or CMMs, eye protection is recommended.

It is the machine supplier's responsibility to ensure that the user is made aware of any hazards involved in operation, including those mentioned in Renishaw product documentation, and to ensure that adequate guards and safety interlocks are provided.

The product and the system components contain no user serviceable parts. No attempt should be made to disassemble any part of the product. In the event of a problem please contact your supplier for assistance.

The cables must meet Renishaw specifications. Incorrect cabling could cause damage to the equipment.

Probe disable will prevent machine backing off in the event of a probe collision.

The MCUlite-2 / MCU5-2 / MCU W-2 must be transported in Renishaw supplied packaging.

This equipment is not suitable for use in a potentially explosive atmosphere.

MCUlite-2, MCU5-2 and MCU W-2 installation and user's guide

www.renishaw.com

MCU environmental conditions

Indoor use	MCUlite-2 and MCU5-2: IP40 MCU W-2: IP31
Altitude	Up to 2000 m
Operating temperature	+5 °C to +40 °C
Storage temperature	MCUlite-2 and MCU5-2: -25 °C to +70 °C MCU W-2*: -20 °C to +60 °C
Relative humidity	Relative humidity 80% maximum (non-condensing) for temperatures up to +31 °C Linear decrease to 50% at +40 °C

* Storing the MCU W-2 battery at high temperatures is not recommended because it prematurely ages the battery. The maximum recommended times for storage of the MCU W-2 battery are:

- 1 week at +60 °C
- 1 month at +45 °C
- 6 months at +40 °C
- 12 months at +35 °C

MCUlite-2, MCU5-2 and MCU W-2 installation and user's guide

www.renishaw.com

MCU references and associated documents

It is recommended that the following documentation be referred to when installing an MCU.

Renishaw documents

[Installation guide: SPA3-2 \(H-1000-5364\)](#)

[Installation guide: UCC T5 \(H-1000-7573\)](#)

[Installation guide: UCC T3-2 \(H-1000-5254\)](#)

[Installation guide: UCC T3 PLUS and UCC S3 CMM controller \(H-1000-2118\)](#)

[Installation guide: UCC S5 REVO-2 CMM controller \(H-1000-7598\)](#)

External documents

National and international standards including the following may be applicable to the finished machine or installation:

BS EN ISO 12100:2003 parts 1 and 2 Safety of Machinery - Basic Concepts, General Principles for Design.

BS EN 60204-1:2006 Safety of machinery - Electrical equipment of machines - Part 1: General requirements.

MCUIlite-2, MCU5-2 and MCU W-2 installation and user's guide

www.renishaw.com

Manual control systems description

 **NOTE:** Only to be used with Renishaw UCC controllers and UCC software.

MCUIlite-2

The MCUIlite-2 is a basic entry level joystick . It has the controls necessary to control a 3-axis touch-trigger CMM and Renishaw head but without the sophistication of an LCD display screen.

 **NOTE:** The MCUIlite-2 is not compatible with UCC1.
The MCUIlite-2 and HCU are not supported on the same installation.

MCU5-2

The MCU5-2 has been developed for use with Renishaw's REVO and PH20 systems, providing the ability to move the CMM in the probe and stylus axis and has an LCD display.

 **NOTE:** The MCU5-2 is not compatible with UCC1 and requires UCCsuite 4.9 or later.

MCU W-2

The wireless manual control unit (MCU W-2) is a CMM joystick designed for use with Renishaw's range of UCC controllers. Based on the MCU5-2 joystick design, the MCU W-2 uses modern battery technology and Bluetooth® radio modules to provide an effective wireless joystick with a maximum range of 25 m and over eight hours between battery changes. A spare battery and an automatic charger are included in the joystick docking cradle.

 **NOTE:** MCU W-2 is not compatible with UCC1 and requires UCCsuite 4.9 or later.

Configuration

All MCU units can be configured to match the customer's requirements using Renishaw UCCassist software. Contact Renishaw CMM support for details.

MCUlite-2, MCU5-2 and MCU W-2 installation and user's guide

www.renishaw.com

MCUlite-2 features

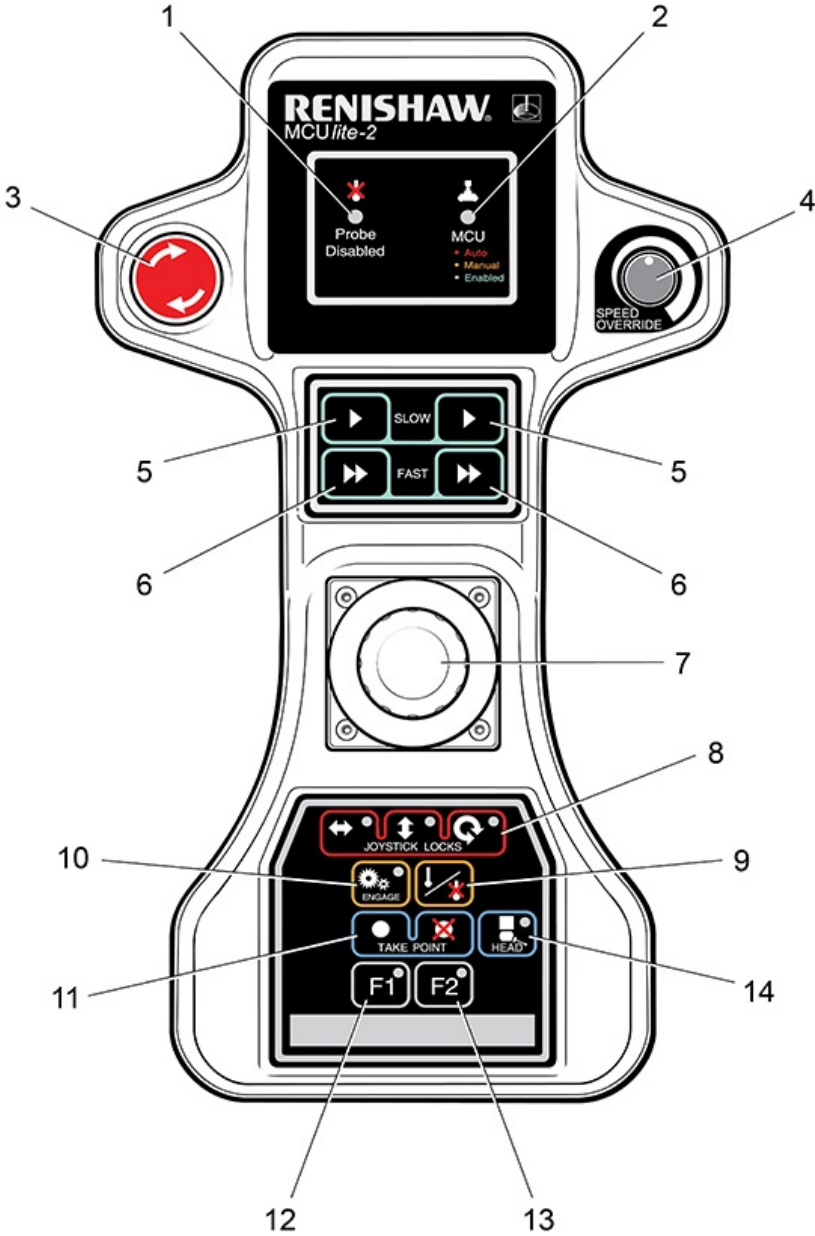

i NOTE: 3 - red or grey

MCUlite-2, MCU5-2 and MCU W-2 installation and user's guide

www.renishaw.com

Key	Description	Key	Description
1	Probe disabled LED (red)	8	Joystick locks (three separate buttons)
2	MCU status LED (tri-colour)	9	Probe disable button
3	Emergency stop switch / stop switch	10	Servo engage button
4	Speed override	11	Take point / cancel last point button
5	Slow speed enable buttons	12	F1 function button
6	Fast speed enable buttons	13	F2 function button
7	3-axis joystick	14	Head enable

MCUlite-2, MCU5-2 and MCU W-2 installation and user's guide

www.renishaw.com

MCU5-2 features

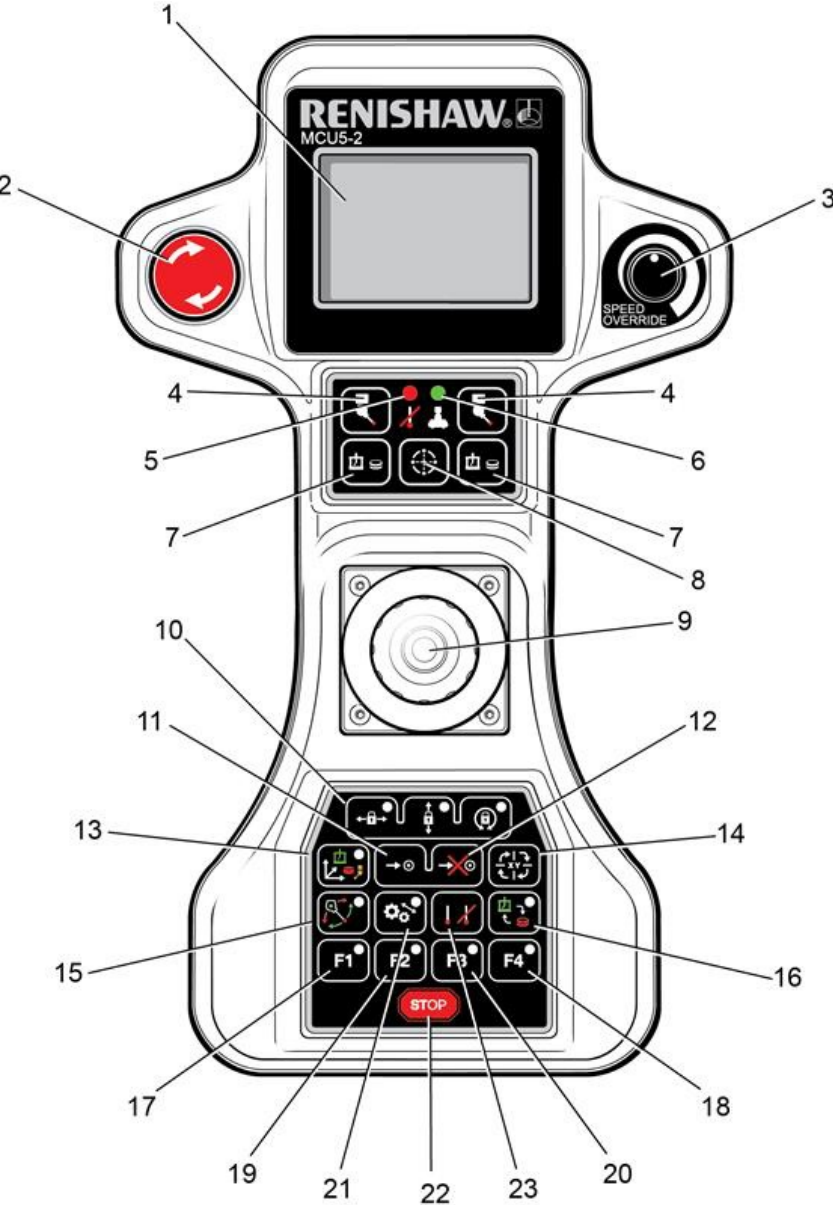

i NOTE: 2 - red or grey

MCUlite-2, MCU5-2 and MCU W-2 installation and user's guide

www.renishaw.com

Key	Description	Key	Description
1	LCD screen	13	Joystick co-ordinate system (axis select)
2	Emergency stop switch / stop switch	14	Joystick orientation
3	Speed override	15	Switch between orbital mode and head mode
4	Joystick enabled head mode (see '6' and '15')	16	CMM movement or rotary table
5	Probe disabled LED	17	F1 function
6	Joystick enabled LED	18	F4 function
7	Joystick control of CMM or rotary table (see '6' and '16')	19	F2 function
8	Bore teach	20	F3 function
9	3-axis joystick with push button	21	Engage servos
10	Joystick locks (three separate buttons)	22	Stop
11	Take point	23	Probe disabled (see '5')
12	Cancel point		

MCUlite-2, MCU5-2 and MCU W-2 installation and user's guide

www.renishaw.com

MCU W-2 features

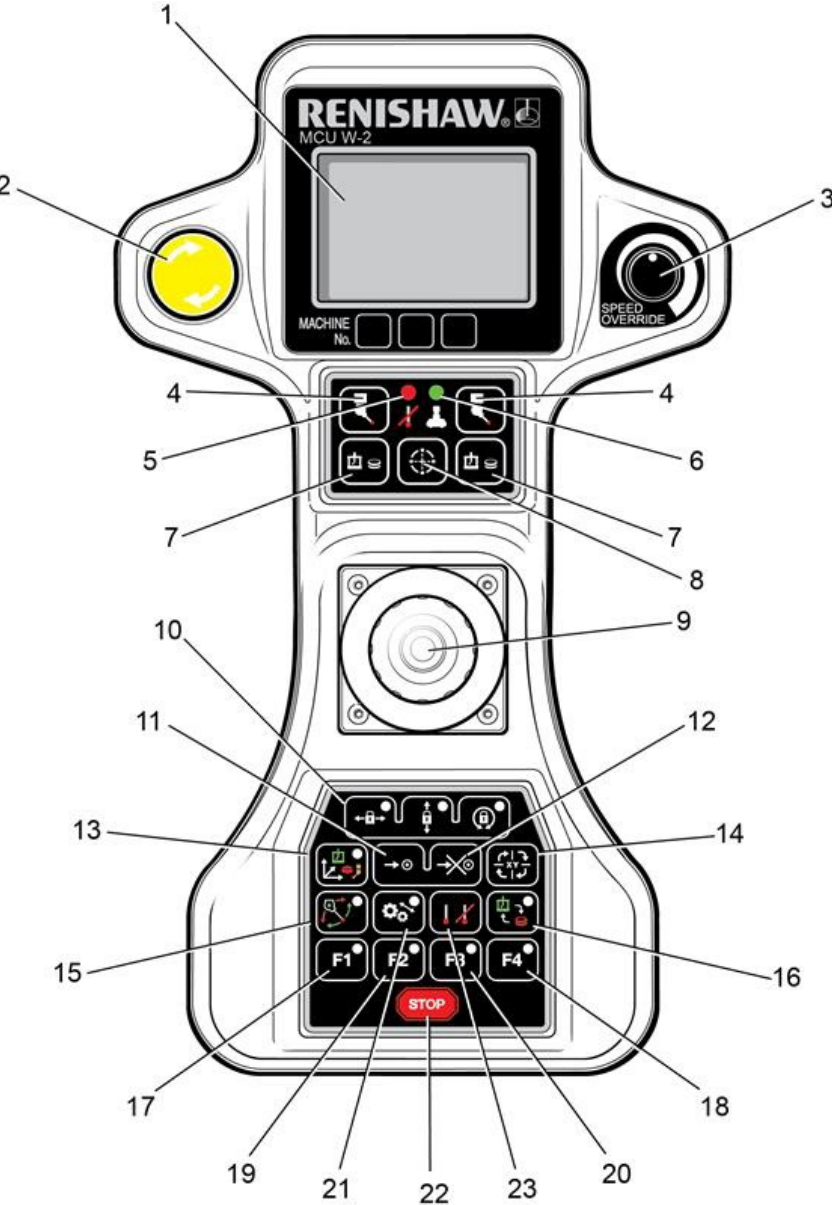

 NOTE: 2 - yellow or grey

MCUlite-2, MCU5-2 and MCU W-2 installation and user's guide

www.renishaw.com

Key	Description	Key	Description
1	LCD screen	13	Joystick co-ordinate system (axis select)
2	Stop switch	14	Joystick orientation
3	Speed override	15	Switch between orbital mode and head mode
4	Joystick enabled head mode (see '6' and '15')	16	CMM movement or rotary table
5	Probe disabled LED	17	F1 function
6	Joystick enabled LED	18	F4 function
7	Joystick control of CMM or rotary table (see '6' and '16')	19	F2 function
8	Bore teach	20	F3 function
9	3-axis joystick with push button	21	Engage servos
10	Joystick locks (three separate buttons)	22	Stop
11	Take point	23	Probe disabled (see '5')
12	Cancel point		

MCUlite-2, MCU5-2 and MCU W-2 installation and user's guide

www.renishaw.com

System operation

All three axis movements are controlled from the one joystick. Moving the joystick left, right, backwards and forwards controls the CMM X and Y movements. The Z-axis is controlled by twisting the joystick clockwise and anti-clockwise (configurable)*.

If a trigger event occurs during joystick operation, the CMM will stop and back away from the surface along the vector that it was travelling. After the back off operation, it is necessary for the joystick to return to its null position for a set period of time before the joystick will permit movement of the CMM. The default value is 0.05 seconds*. The back-off speeds and distances are defined by the UCC configuration settings*.

* These values and configuration settings will have been set by your CMM service provider.

Head mode



Holding one of these buttons enables movement of the head. Pushing the joystick forwards and backwards will operate the A-axis and twisting the joystick will operate the B-axis.

When in orbital mode (LED lit) the head and machine move relative to the stylus ball.

Indicator LEDs

MCUlite-2:



MCU5-2 and MCU W-2:



The left LED indicates that the probe is disabled. In this mode, if the stylus is driven into a surface the CMM will NOT stop.

The right LED indicates that the joystick is enabled i.e. the joystick will move the CMM or head when deflected.

MCUlite-2, MCU5-2 and MCU W-2 installation and user's guide

www.renishaw.com

Joystick enable

MCUlite-2:

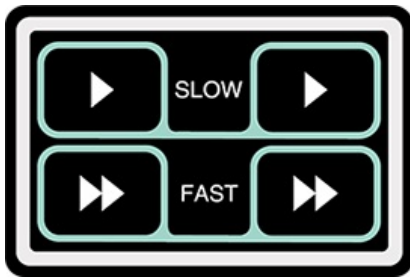

MCU5-2 and MCU W-2:



The joystick enable button(s) are intended to be used to prevent the accidental movement of the machine. Two actions are required to initiate CMM motion: press joystick enable button and operate the joystick.

Holding this button down enables movement of the CMM or rotary table (dependent upon the status of the CMM / rotary table button) :

With CMM selected

- Twisting the joystick moves the Z-axis
- Left, right, backwards and forwards moves the X and Y-axes

Bore teach



Place the stylus into a bore and press the 'joystick enable' and 'bore teach' buttons simultaneously:



The machine will take x4 points (0,90,180 and 270) perpendicular to the stylus axis.

If the 'head mode' and 'bore teach' buttons are pressed simultaneously the bore is measured with head touches (PH20 and REVO / RSP2 only):



MCUlite-2, MCU5-2 and MCU W-2 installation and user's guide

www.renishaw.com

Joystick axis locks

MCUlite-2:



MCU5-2 and MCU W-2:



These permit the locking of one or more axes of the CMM, ignoring any joystick deflections for that axis. On each of the axis lock buttons there is an LED indicator that will light red when the respective axis is locked. On the MCU display there will also be a padlock symbol next to the respective axis (see below). These buttons toggle the lock on / off.

i **NOTE:** If an axis lock is released when the joystick is deflected, that axis is immediately free to move.

i **NOTE:** When the CMM joystick orientation function is operated, the axis locks will be transposed on the MCU.

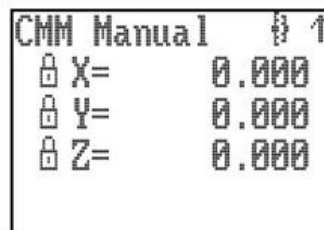
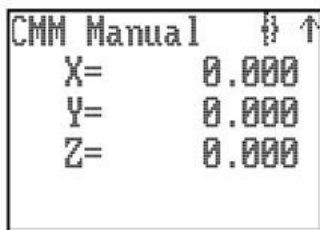

When the MCU is in head mode, the axis locks are applied to the relevant head axes. When the joystick is in head mode and a REVO / REVO-2 / PH20 head is fitted, the left / right axis lock button is used to initialise and cancel 'SNAP ON'. 'SNAP ON' is the ability to move the head to the nearest multiple of a defined head angle. In UCCassist-2 the variable can be set to define the resolution of manual head moves (e.g. 5°). These axis locks will only be active during manual (MCU) controlled CMM movements. When the CMM is under DCC (direct computer control) operation, all axis locks will be released and re-latched when returning to manual operation.

MCUlite-2, MCU5-2 and MCU W-2 installation and user's guide

www.renishaw.com

Take point / cancel point

MCUlite-2:



MCU5-2 and MCU W-2:



This button is designed to allow the user to record or cancel chosen machine positions. When a program is being generated by the teach and learn method, the take point button is used to permit the CMM to record a waypoint and use it in the program. Use of the cancel point button will indicate to the application software that the point just taken (either a touch point or a position generated by the take point button) should be removed from the program. The cancelling process can be repeated many times and the front-end program will use it to delete multiple stored points.

NOTE: When the take point button is pressed, the machine's XYZ position will be recorded and a waypoint created.

Axis select button



The axis select button changes the CMM motion in any one of three different axis systems - machine, part or stylus:

Machine axis (green LED)



In this axis system, the joystick directly controls the machine axes, i.e. a forward deflection of the joystick produces a pure Y+ movement of the CMM. This is the default machine setting when the machine is initialised.

Part axis (red LED)



In this axis system, the joystick controls the machine within the current part axis system. i.e. a forward deflection of the joystick produces a movement in the part Y+ direction. This could be a compound of two or three machine axes.

MCUlite-2, MCU5-2 and MCU W-2 installation and user's guide

www.renishaw.com

Stylus axis (amber LED)



In this axis system, the joystick controls the machine axes in the axis system of the selected stylus. i.e. a twist (Z) deflection of the joystick produces a movement along the axis of the probe stylus. This could be a compound of two or three machine axes. The stylus axis is a secondary part co-ordinate system, applicable only to the MCU joystick, and this needs to be updated by the application software to reflect the active stylus axis.

The axis system in which the MCU is moving the CMM (machine, part co-ordinate or stylus) is indicated on the LCD by an M, P or S and by a tri-colour LED mounted below the axis select button. Pressing the axis select button will enable the user to scroll through the three axis systems.

To change to the required axis system the axis select button must be pressed and held on the desired axis system. This selection is confirmed by simultaneously pressing the joystick enable switch. Both switches can then be released. This change procedure prevents unintentional changing of the axis system which could give unexpected machine movement.

Joystick orientation button - MCU5-2 and MCU W-2



The joystick orientation button changes the mapping of joystick deflection direction to CMM axis. This allows the user to move freely around any side of the CMM and transpose the joystick orientation such that the machine's X-axis and Y-axis correspond to joystick direction of deflection. If any axis lock is asserted and the joystick orientation is changed then the relative axis lock will also be transposed.

An arrow in the top right of the LCD indicates the orientation of the MCU. Pressing the joystick orientation button will enable the user to scroll through the four operational positions. The direction of the arrow indicates the +Y axis direction of the machine when the machine co-ordinate system is in force.

NOTE: When switching the system to CMM auto mode, the joystick orientation feature will drop out and then be reasserted when the system is placed into CMM manual mode.

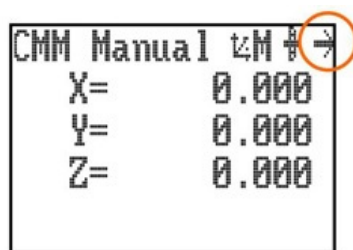
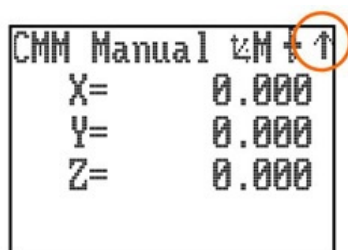

MCUlite-2, MCU5-2 and MCU W-2 installation and user's guide

www.renishaw.com

Orbital mode



When head mode is active and this button is pressed, joystick deflection rotates the CMM around the stylus tip.

CMM / rotary table



This button switches between CMM and rotary table operation.

If there is no rotary table this button has no effect. The rotary table is set up during commissioning in UCCassist-2.

Function buttons

MCUlite-2:



MCU5-2 and MCU W-2:



The application software can define the function buttons. Their status can be read at any time and in any mode. These buttons have no effect on the UCC controller as they are solely for the use of the front-end software. The associated keypad LEDs can also be switched on and off at any time. For example, one of the buttons may be used to initiate a circle measurement command when the system is in a manual mode and is being used for teach and learn programming.

MCUlite-2, MCU5-2 and MCU W-2 installation and user's guide

www.renishaw.com

Engage button

MCUlite-2:



MCU5-2 and MCU W-2:



The engage button gives the CMM user the ability to engage or disengage the servos whilst the CMM is in manual mode. This button is configured as a toggle switch and has an associated LED to indicate the servo status. The LED identifies the various operational states as listed below. A symbol at the top of the LCD screen (shown below) also indicates whether the servos are engaged.

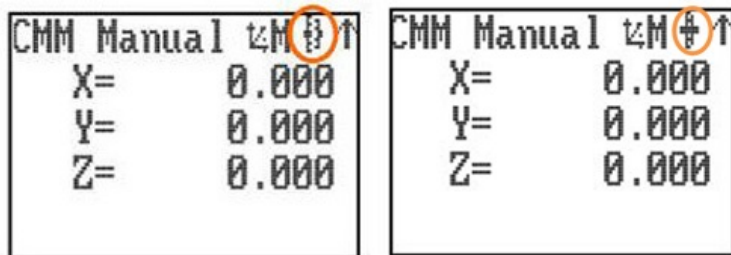

LED off - The CMM servos are disengaged.

LED amber - The servos are in the process of engaging.

LED red - The servos are engaged but the joystick is not enabled.

LED green - The servos are engaged and the joystick is enabled and ready.

Operating the disengage switch disengages only the CMM axes, it does not disengage the REVO or PH20.

Keypad STOP button - MCU5-2 and MCU W-2



The STOP button gives the operator the ability to rapidly stop the CMM, REVO head and PH20 without disengaging. When the CMM has stopped, the system stays in hold state with both the CMM and head engaged.

STOP button - MCU W-2

This is the yellow or grey STOP button mounted on the MCU W-2 joystick, or the grey button on the MCU5-2. When this button is pressed, all CMM and motorised head motion is halted.

MCUlite-2, MCU5-2 and MCU W-2 installation and user's guide

www.renishaw.com

Emergency STOP switch

A red or grey emergency STOP switch is mounted on the MCUlite-2, MCU5-2 and on the MCU W-2 cradle which is hard wired to the UCC controller. It complies with EN13850 and when connected to a UCC / SPA the system can comply as either a category 2 or category B E-STOP system as defined in EN954-1:1996 (ISO13849-1:1999). When this switch is operated power to all the CMM axes is removed.

Speed override - MCUlite-2 and MCU5-2

Speed override controls the machine speed when the CMM is running a program under DCC mode. It will also control the speed of the REVO head or PH20 if fitted. The LCD screen displays a percentage value of the programmed move speed when in DCC operation as shown below. If the speed override is set to less than 10%, the speed percentage shown on the LCD display will flash.

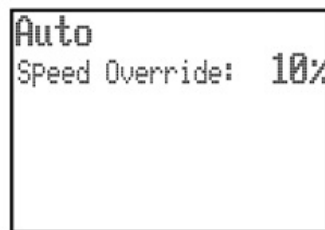
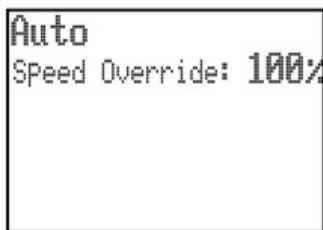

Speed override - MCU W-2

If the joystick is taken out of range while the CMM is moving in automatic mode the loss of the radio link will not stop the CMM, but if the speed control is changed while the joystick is out of range the following actions are required when the joystick is reconnected.

- If the new demanded speed is lower than the value set before the link was lost then the CMM will immediately slow down to the new speed when the joystick link is reconnected.
- If the new demanded speed is higher than the value set before the link was lost then, when the joystick link is reconnected, the CMM will keep on moving at the old speed but the display of % speed will be reversed (white on black as shown below). The speed will be frozen until the speed control is turned down through the old speed value. The speed control will then again be functional.

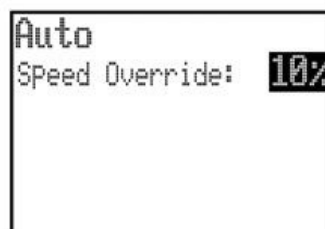
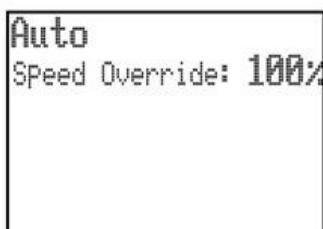

MCUlite-2, MCU5-2 and MCU W-2 installation and user's guide

www.renishaw.com

Probe disable button

MCUlite-2:



MCU5-2 and MCU W-2:



The probe disable button gives the CMM user the ability to move the CMM while the probe is triggered or disconnected by disabling the probe trigger signal.



WARNING: When operating in this mode the probe is disabled and therefore probe contact with a surface will NOT stop the CMM. No measured data will be returned to the CMM host computer.







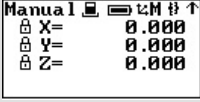

The probe disable function will only work while in manual mode and cannot be applied while in automatic / DCC mode. To disable the probe, press and hold the joystick enable button and then press the probe disable button. The CMM can now be moved irrespective of the probe trigger status. Releasing the joystick enable button cancels the probe disable function. In all modes the application of probe disable is confirmed by the red probe disabled LED being illuminated.

Specific MCU W-2 screen displays

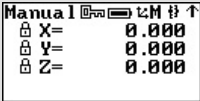
Wireless communication	
	Wireless communication is activated
	Manual operation, wireless communication - ON, battery - fully charged
	Joystick pairing
	Pairing lost, (out of range or loss of power to cradle) waiting for the connection
	Pairing failed

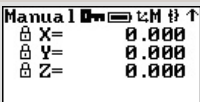
MCUlite-2, MCU5-2 and MCU W-2 installation and user's guide

www.renishaw.com

Joystick docking			
		MCU W-2 joystick is docked in the cradle	
		Manual operation, MCU W-2 joystick docked, battery fully charged	
The lock			
		The key in the MCU W-2 cradle is in the locked position, the MCU W-2 joystick is deactivated and manipulation of it will not result in any CMM movement	
		Manual operation, MCU W-2 joystick locked / disabled, battery fully charged	
Out of range			
		The link has been lost due to the MCU W-2 joystick being out of range or the power supply to the MCU W-2 cradle failing	
		Manual operation, MCU W-2 joystick out of range, battery fully charged	
Battery status			
Battery full	Battery half full	Battery empty	Battery fault / missing
			

Power-saving screen back light

If the joystick has not been used for 60 seconds, the back light turns off.

To activate the screen back light press the joystick enable button.

MCUlite-2, MCU5-2 and MCU W-2 installation and user's guide

www.renishaw.com

MCU installation

Part numbers

There are several MCU joysticks available:

- A-5331-0015 - MCUlite-2 kit
- A-5734-0100 - MCU5-2 kit
- A-5121-0400 - MCU W-2 kit (includes batteries)

Grey button version

- A-6078-0258 - MCUlite-2
- A-5734-0900 - MCU5-2
- A-5734-1400 - MCU W-2 (does not include batteries *)

- A-5331-0020 - HT20
- A-5735-0400 - HT500
- A-5734-1300 - HT500RC (does not include batteries *)



* **NOTE:** These kits do not include batteries. When placing an order, please remember to include the MCU W battery kit (Renishaw part number A-5381-0095).

Each of these kits are provided with a 5 m flexible joystick cable. Replacement cables are available from your machine supplier or directly from Renishaw.

- A-1016-8098 - 5 m cable

Connecting the MCU to the UCC system

The MCU joystick kits include a 5 m flexible cable provided as standard. The cable is fitted from 9-pin D connector on the rear of MCU to a 9-pin D connector on the rear of the SPA3-2.

MCUlite-2, MCU5-2 and MCU W-2 installation and user's guide

www.renishaw.com

Connecting to the SPA3-2

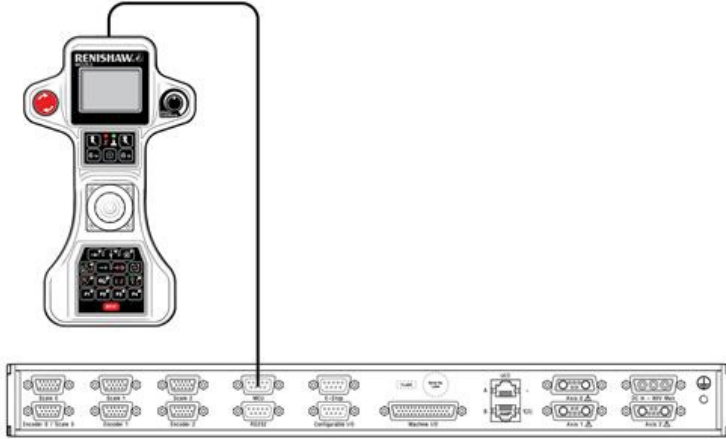

The emergency stop button on the MCU5-2 or MCU W-2 has a dedicated circuit that is fed directly into the rear of the SPA3-2 servo power amplifier or UCC controller.

MCUlite-2, MCU5-2 and MCU W-2 installation and user's guide

www.renishaw.com

MCU fault finding

Many operating problems can be solved by checking the MCU status LEDs, the system configuration and current operating conditions.



NOTE: As with most cable connected ancillary equipment, the actual cable is the most vulnerable part, particularly with a joystick where it can be trapped by the part under inspection, pulled if caught by machine motion, trodden on, run over, etc. If any malfunction with the MCU occurs, the first step should be to examine the cable.

Suspect operation of joystick or buttons

There is a comprehensive test program for the MCU joystick operation and button function within UCCassist-2. Please refer to the UCCassist-2 user's guide (Renishaw part number H-1000-5224) for details.

The joystick will not move the CMM

Several conditions have to be satisfied before joystick controlled moves can be made:

- The joystick must be connected to the UCC and have been set up in the configuration file
- The joystick must be 'enabled'
- The MCU 'joystick enable' button must be pressed down
- The axis locks must not be applied
- The CMM application software must be in manual (joystick) mode
- The probe must not be 'deflected', unless probe disable is on
- No limit switches should be open, unless disabled
- The CMM position must be inside all 'soft limits' if these are enabled

The speeds are too low or too high

- Check the correctness of the joystick speeds and accelerations that are set in the UCC configuration file
- Check the operation of the fast / slow switch - higher speeds will be obtained when this switch is active

The motors disengage during joystick operation

- If the joystick maximum speed is set to a high value, the machine may be able to exceed the maximum move speed and may cause an overspeed error
- If the joystick maximum acceleration is set too high, the motor signals may attempt to exceed the overdrive limits and cause an overdrive fault
- If the system proportional gains are set too high, or the velocity gains are too low, an overdrive fault may occur

MCUlite-2, MCU5-2 and MCU W-2 installation and user's guide

www.renishaw.com

Speed override does not work correctly

- This feature must be enabled separately from the general joystick enabling function. It is an entry in the UCC configuration file

 **NOTE:** Speed override ONLY works on DCC moves and scanning. It is not operational when the MCU is in manual (joystick) mode.

Servos will not engage

- E-STOP not connected correctly
- E-STOP still asserted
- An outer limit switch is activated

No screen display

- Check cable connection

MCUlite-2, MCU5-2 and MCU W-2 installation and user's guide

www.renishaw.com

MCU maintenance

The MCU5-2 and MCU W-2 have no user serviceable parts. There is an E-STOP repair leaflet (Renishaw part number H-1000-7601) available for these joysticks. Should a unit become defective for any other reason then it should be returned to the nearest Renishaw service centre.

The MCU may be kept clean by wiping with a clean, damp, lint-free cloth.



CAUTION: Do not use solvents.

Replacement connection cables can be purchased through the CMM provider or direct from Renishaw:



CAUTION: Always follow the safety instructions given in this guide. Failure to do so could adversely affect the performance of the MCU system and / or lead to personal injury.



NOTE: The external surfaces of all system components can be cleaned with a water damped cloth but all parts should be kept dry. Keep MCU contacts clean and free from dirt using non-abrasive material.

MCUlite-2, MCU5-2 and MCU W-2 installation and user's guide

www.renishaw.com

Requirements

Software requirements for installation

The required version of UCCsuite:

- MCUlite-2 - UCCsuite 4.9 and later
- MCU5-2 - UCCsuite 4.9 and later
- MCU W-2 - UCCsuite 4.9 and later

PSU specification requirements for MCU W-2 operation

Should a replacement PSU be required it is recommended that it be purchased from Renishaw, or it must meet the following specification:

- Output +24 Vdc, 0.6 A
- 2.5 mm dc jack connector (centre positive)
- To comply with electrical safety legislation the supply negative must be connected to the earth of the ac input, must be single fault tolerant and approved to EN 62368-1

MCUlite-2, MCU5-2 and MCU W-2 installation and user's guide

www.renishaw.com

MCU W-2 cradle - switching on and off

The MCU W-2 cradle key is designed to control the use of the MCU W-2 joystick, i.e. to activate or deactivate it when needed.

MCU W-2 joystick activation and deactivation

To activate the joystick the operator has to insert the key as shown in the picture and turn it from OFF to ON. These positions are clearly indicated on the MCU W-2 cradle.

The operator can disable the joystick by switching the key to OFF and removing the key from the cradle. This prevents the CMM machine from being moved via the joystick.

The key is only removable when it is in the OFF position, which is confirmed by a key symbol displayed on the MCU W-2 screen.



MCU W-2 locking position ON, joystick activated



MCU W-2 locking position OFF, joystick deactivated



MCUlite-2, MCU5-2 and MCU W-2 installation and user's guide

www.renishaw.com

Pairing the MCU W-2 joystick with the cradle

The MCU W-2 is supplied pre-paired and this procedure is only required if part of the system is replaced.

Prior to pairing the MCU W-2 cradle to the joystick please ensure that:

- The MCU W-2 cradle power cable is unplugged
- The battery in the MCU W-2 joystick has been removed

To pair the MCU W-2 joystick to the cradle please do the following:

1. Plug-in power to the cradle.
2. Wait five seconds for the cradle to power up and the LED start-up sequence to complete.
3. Push and hold the cradle reset button until the pairing status LED rapidly flashes blue. This typically takes three seconds.

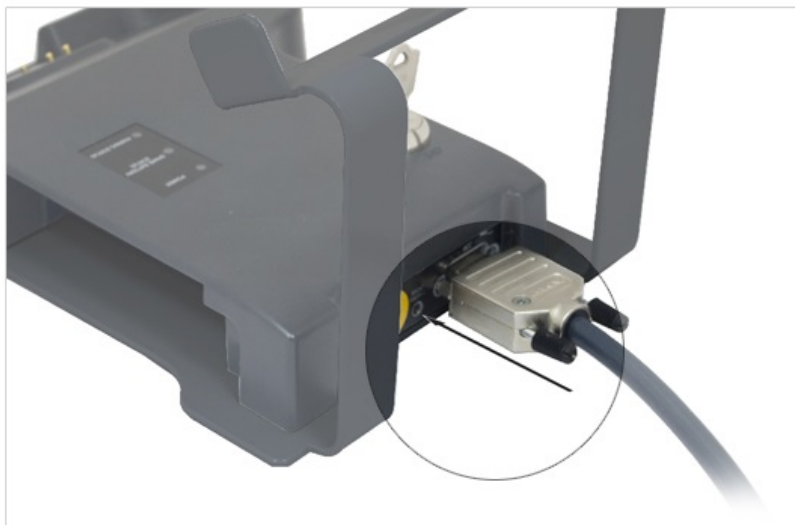

MCUlite-2, MCU5-2 and MCU W-2 installation and user's guide

www.renishaw.com

4. Wait for the pairing to fail, indicated by the pairing status LED turning solid red. This typically takes one minute.
5. Remove the cradle power and wait for the LEDs to turn off.
6. Replace power to the cradle.
7. Wait for the pairing cradle LED to turn RED, then press and hold the cradle reset button until the pairing status LED flashes blue.
8. Push and hold the mode selection button and insert the battery. The link sequence is started once you see)))) on the LCD screen – stop holding down the mode selection button.



9. Pairing is successful once the pairing status LED is solid blue.
10. If unsuccessful, the cradle will timeout after two minutes and the pairing status will turn solid red. If this happens restart the complete procedure again.

The operating range of the MCU W-2 Bluetooth® communication

The wireless communication link operates up to a range of 25 m line-of-sight between the MCU W-2 joystick and the cradle. Non line-of-sight range is dependent on the number and type of obstructions.

MCUlite-2, MCU5-2 and MCU W-2 installation and user's guide

www.renishaw.com

The use of the ID labels

MCU W-2 labels should be used to match the joystick with its paired MCU W-2 cradle. They are intended to avoid confusion if multiple MCU W-2 systems are operating in the same area. Ensure that the ID labels are stuck to both the MCU W-2 joystick and cradle. Ensure that the ID labels are updated if an MCU W-2 joystick is paired with a new cradle.



MCUlite-2, MCU5-2 and MCU W-2 installation and user's guide

www.renishaw.com

MCU W-2 cradle LED indicators

There are three LEDs on the MCU W-2 cradle.

The specification for the MCU W-2 LEDs is as follows:

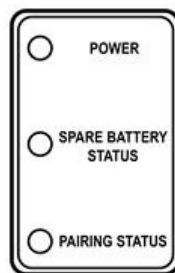

Power LED

LED status	Interpretation
Not lit	No power
Amber	Power, but the key-switch is in the OFF position, meaning the joystick is locked and deactivated
Green	Power, and the key-switch is in the ON position, meaning the joystick is unlocked and activated

Spare battery status LED

LED status	Interpretation
Not lit	No battery
Amber	Battery charging
Green	Battery fully charged
Slow flashing red	Battery fault

MCUlite-2, MCU5-2 and MCU W-2 installation and user's guide

www.renishaw.com

Pairing status LED

LED status	Interpretation
Red	Cradle has not been paired with a joystick
Slow* flashing blue	Partner joystick is out of range or not switched on
Fast* flashing blue	Pairing with joystick
Blue	Normal operation (connected to joystick)

Any other combinations of colours or flashing patterns are classified as an error.



* **NOTE:** A slow flash is twice per second, fast is five times per second.

MCUlite-2, MCU5-2 and MCU W-2 installation and user's guide

www.renishaw.com

MCU W-2 battery operation and maintenance

The MCU W-2 system requires two batteries. One battery should be placed in the joystick and the spare one should be kept in the cradle where it is continuously recharged when the cradle is powered and switched on. The battery in the handset is automatically recharged when it is replaced on the cradle so it should be returned whenever the joystick is not in use.

MCU W-2 first usage

Before using the MCU W-2 for the first time please check the batteries for damage or leakage. If battery damage or leakage is found do not use the battery. The batteries are shipped 30% charged and can be used immediately.

The battery charge status is confirmed in the screen display.

When the battery charge status is low, which is indicated in the screen display and an audible beep, replace it with the spare battery from the cradle.

Maintenance

A new, fully charged battery powers the MCU W-2 for at least 8 hours under normal usage conditions. Elevated temperatures will reduce battery life. If audible beeps are heard from the handset, it means the battery power is running low. The joystick battery should be exchanged with the one in the cradle or alternatively, replace the joystick on the cradle for recharging.

Safety related to the MCU W-2 battery usage

Please refer to the appropriate section of the MCU W-2 safety information.

Renishaw plc
New Mills, Wotton-under-Edge
Gloucestershire, GL12 8JR
United Kingdom

T +44 (0)1453 524524
F +44 (0)1453 524901
www.renishaw.com/cmmsupport



**For worldwide contact details,
please visit our main website at
www.renishaw.com/contact**