





XK10 alignment laser system

Why you need the XK10 alignment laser system

The XK10 alignment laser system makes building and servicing machines easier by removing the need for many granite artefacts such as straight edges, squares and parallels. The XK10 system provides all the measurements needed for machine build, including straightness, squareness and parallelism, stores the measurement data on a portable display unit, and produces reports, where required.

<input checked="" type="checkbox"/>	Build	
<input type="checkbox"/>	Verify	
<input type="checkbox"/>	Compensate	
<input type="checkbox"/>	Diagnose	

www.renishaw.com/xk10

 #renishaw



Process foundation

Component quality is dependent on machine performance. Without understanding the errors in a machine it is impossible to have confidence that your components will meet specification.

Accurate measurement and setup of machines is the foundation of process control, providing the best performance and stable environment for the machining process. Quantifying process capability reduces costs and improves efficiency.

A single digital solution for alignment of machine tools

A system to check alignment during machine construction is essential for an accurate, efficient, and reliable machine tool. This avoids errors being identified after the machine has been built, when they are much more difficult to correct. Regular alignment checks are also valuable during on-site service, maintenance or following a collision.

Laser alignment is a method which offers a fast, simple, and versatile alternative to traditional techniques such as granite squares, dial gauges, autocollimators and metrology artefacts.

The XK10 alignment laser system has been developed to make building machines easier. The compact size and versatile fixturing mean XK10 can be used in many configurations, enabling measurement of errors across linear and rotary axes for all types and sizes of machine tool.

After axis alignment, the XK10 records measurements digitally and can provide full error reports, minimising operator error and the manual documents that exist with traditional alignment methods.

Benefits over traditional methods



Linear axes

Traditional methods of identifying alignment errors involve measurements with granite blocks, precision inclinometers and dial gauges. These methods are manual and highly susceptible to operator errors. They can also be difficult to perform, especially on machines with long axes (2 m and over) or where micron level accuracy is required.

The XK10 alignment laser system is a lightweight, compact digital solution. It can be used to align and measure parallelism, straightness and squareness of linear axes.

Live error readings allow adjustments to be made to the machine whilst the laser is in place.



Rotary axes and spindles





Traditional methods of identifying rotational errors, such as spindle direction (or pointing) and shaft alignment involve using test bars and dial gauges. This can be difficult to perform on larger machines, and is susceptible to misinterpretation and calculation errors.

The XK10 alignment laser system can be mounted directly in spindles or chucks to carry out accurate measurements of rotational error types. Automatic analysis gives immediate results following measurement, avoiding user errors and providing a digital record.

The compact design and intuitive software allows measurements to be captured quickly and easily.

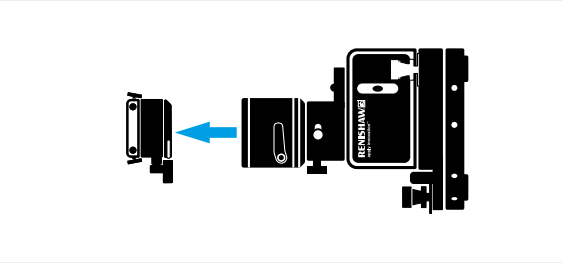

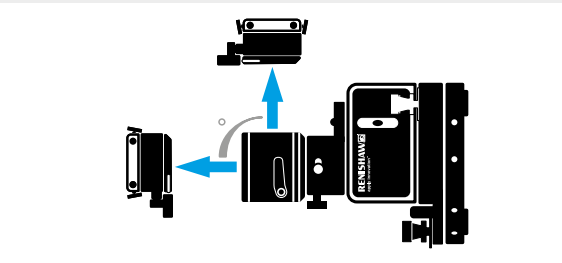
XK10 measurement types

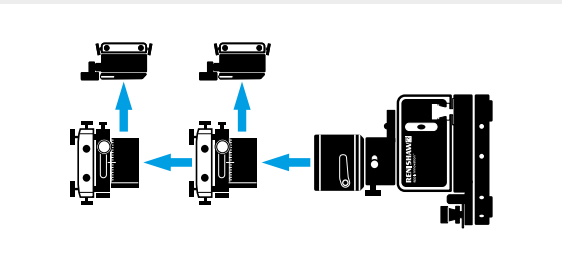
For linear axes



	<h3>Straightness</h3> <p>Measures both horizontal and vertical straightness simultaneously. Essential for all machine builds to ensure accuracy when mounting and aligning stages and guideways.</p>	
	<h3>Squareness</h3> <p>Measures the orthogonality of two machine axes. This would typically be used to ensure that machine arms and beds are at right angles, to align machine rails, or when squaring separate machine assemblies.</p>	
	<h3>Parallelism</h3> <p>Measures the straightness deviation or overall misalignment angle between two nominally parallel axes. It is typically used during the manufacture of machine tool structures.</p>	

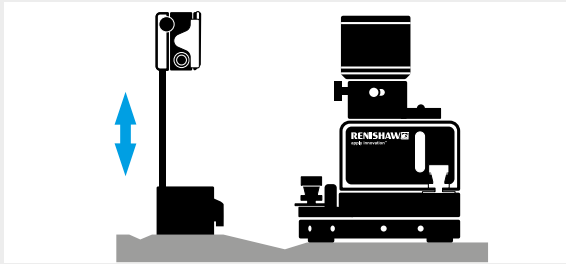

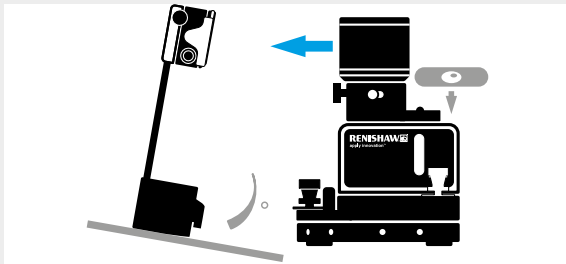
For installation and automation

	<p>Flatness</p> <p>Measures vertical deviation along a machine bed, rails, or other machine planes. A versatile mode that can measure continuous or interrupted planes, for example to measure height differences between fixtures or machine sub-assemblies.</p>	
	<p>Level</p> <p>Measures machine level with respect to gravity, or to another machine surface. This is typically used to align machine stages and to check gradual distortion of machine structure over time. It can also be used to level one machine relative to another.</p>	

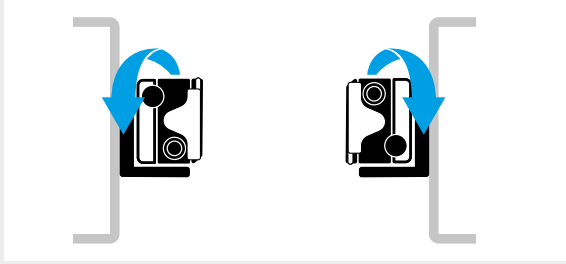
For rotary axes and spindles

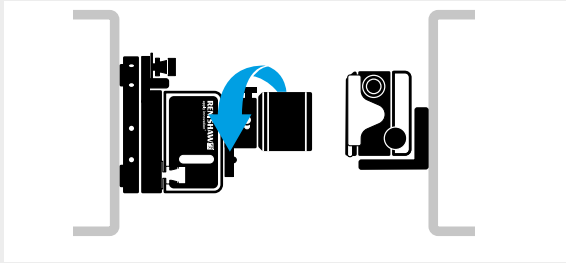
	<p>Coaxiality</p> <p>Measures the deviation of one rotating centre from another. This is typically used for alignment of rotary spindles or chucks, for example when building a lathe.</p>	
	<p>Spindle direction</p> <p>Measures the angle at which a spindle or chuck is pointing. This can be used for any spindle or chuck alignment, to ensure that it points in the same direction through a full 360° rotation.</p>	

System overview

Launch unit

The launch is the primary method of laser transmission for the majority of measurement types. It has a measurement range of 30 m.

- **Flexible positioning** – The launch unit is battery powered and compact. It has magnetic feet, adjustable levelling screws and precision levels built-in for easy placement.
- **Rotating head** – Allows easy beam pointing with the capability to measure flatness using a series of grid points.
- **Two laser apertures** – Allows capability to measure squareness using the built-in pentaprism to quickly switch the beam through 90° and flexibility of mounting.

The launch is used with the M unit for all measurements.



Static (S) unit and Moving (M) unit

The S unit and M unit contain both transmitters and receivers, and can be set up in different configurations depending on the error type under test.

- **Wireless communication** – The S unit and M unit can communicate with the display unit via wireless connection. The units also support wired connection where required.
- **Flexible and lightweight** – Battery powered and compact, for easy placement.
- **Easy alignment** – Achieved using the built-in beam steerers.

The S unit and M unit can be used in combination for rotational measurements.





Display unit

The display unit is used for live feedback of alignment and to capture results.

- **Wireless communication** – Communicates with the transceivers via wireless connection.
- **Portable** – Powered by a rechargeable battery, allowing portable operation up to 30 hours.
- **Easy to use** – Simple interface with functions for each measurement.
- **Compact and ergonomic design** – With soft grips and large buttons.

Additional accessories

XK parallelism kit

The XK parallelism kit is an additional accessory required to carry out parallelism measurements. It allows measurement of two nominally parallel axes to be carried out without moving the launch.

Accurate – 90° deflection of the laser beam. Versatile adjustments allow ease of alignment.



XK tripod mount kit

The XK tripod mount kit is available for use with a tripod when there is no space to directly mount the launch.





“ The reports that the XK10 produce are also highly intuitive, and through a choice of tables or charts, clients can very quickly determine the status of a machine tool during an acceptance inspection.

Hurco Manufacturing Ltd. (Taiwan) ”

XK10 software

Pre-installed software has been designed with the user in mind to provide an intuitive and simple interface with easy navigation.

Easy to use

A step-by-step approach for each measurement type guides the user through each process, reducing reliance on highly skilled operators.

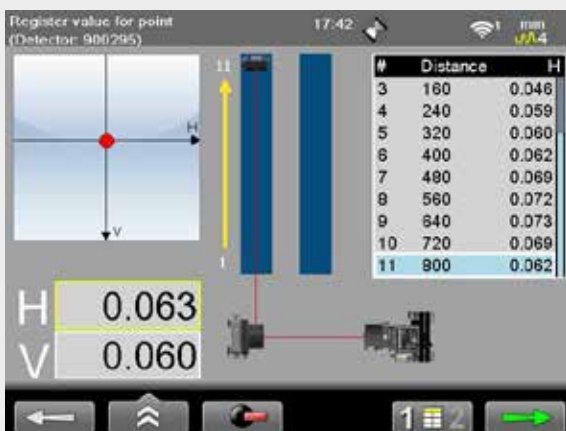

Live readings

Live readings and graphical displays are shown on screen during alignment and measurement.

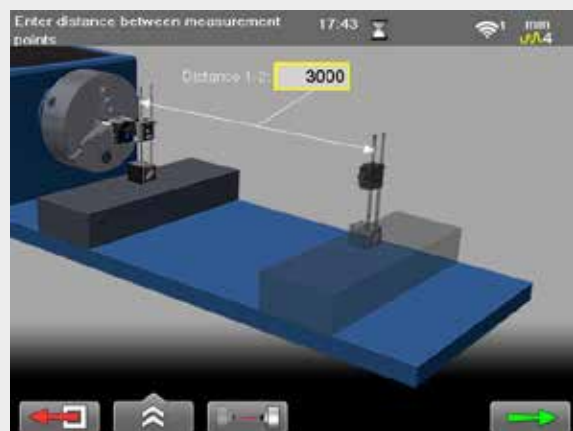

CARTO software suite

Straightness and parallelism analysis, featured in the CARTO Explore application, provides reliable results to check and correct machine alignment.



Data export

XK10 software generates reports detailing the results of each measurement. The reports can be exported via USB (cable or memory stick) in both PDF and XML formats.

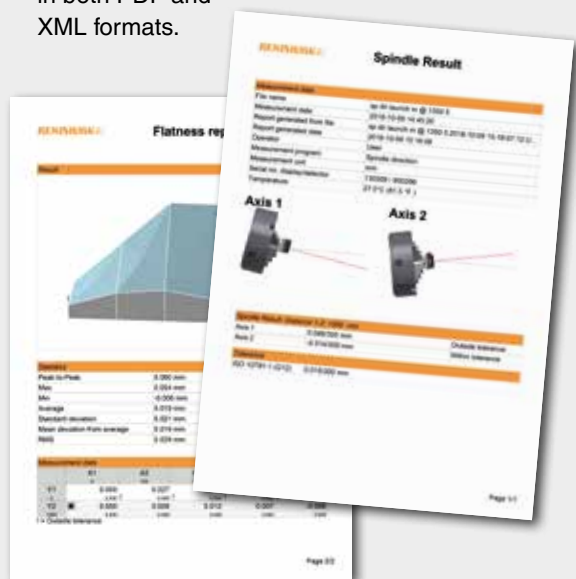

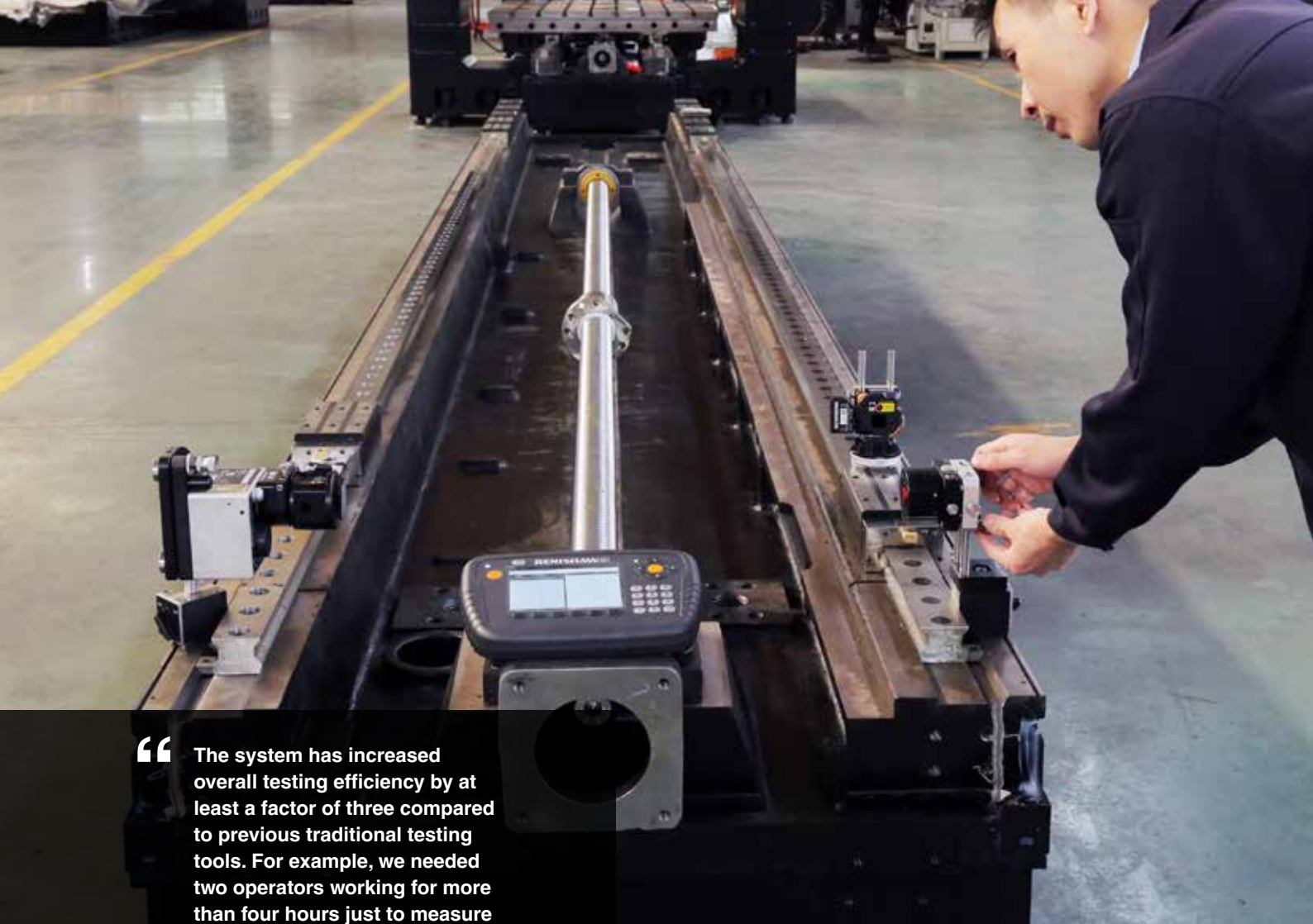

“

The system has increased overall testing efficiency by at least a factor of three compared to previous traditional testing tools. For example, we needed two operators working for more than four hours just to measure the linearity, flatness, verticality and parallelism of a 20 m gantry-type machining centre. Since we brought in the XK10, a single operator can complete the process in less than two hours.

TAKAM Machinery Co., Ltd (China)

”

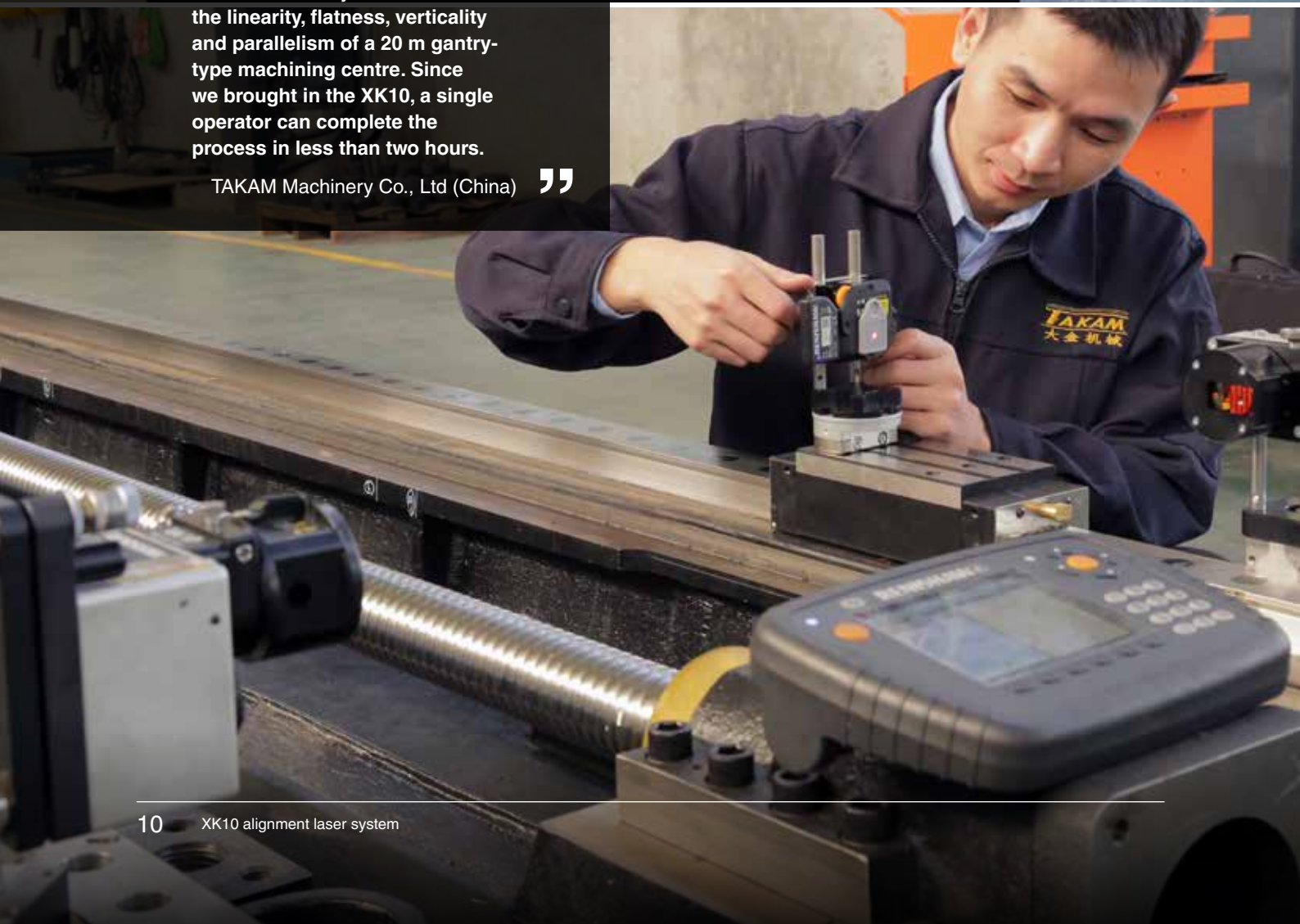

Versatile fixturing

The XK10 is supplied with versatile fixturing suitable for different machine configurations.

Magnetic mounting

The launch unit has magnetic feet for mounting horizontally or vertically to a machine surface. The S unit and M unit can be mounted on magnetic bases for improved flexibility. Each kit contains one standard magnetic base, and one mounting block with a rotatable head.



Spindle adaptors

These allow simple fitment of the launch unit or receivers into a lathe or a spindle. The standard kit contains adaptors for the launch unit, S unit and M unit.



Launch unit extrusion mount

The extrusion mount allows the launch unit to be attached to an extrusion for mounting to a rail or machine base. Fixing the position of the launch onto the machine minimises external errors such as vibration and movement that may occur if a tripod is used.

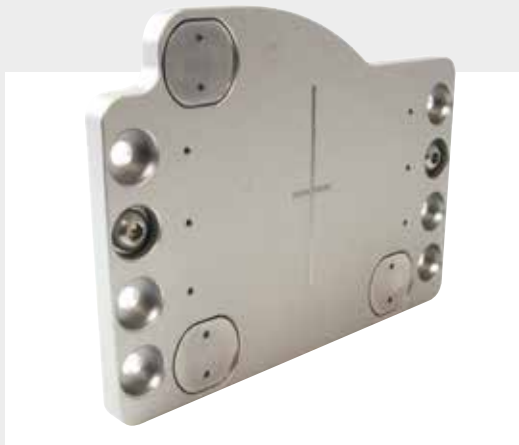

Reference mount

This enables the M unit to be magnetically mounted onto the side or edge of a rail, and easily located along its length. The reference mount is designed to give repeatable positioning along the length of the rail. It also allows easy rotation of the S unit or M unit, which can be locked at 90° intervals.





“ The XK10 system is very portable and easy to set up. Our operators only need to follow the display unit instructions to complete a measurement process. Overall, I estimate that our machine tool inspection efficiency has been improved by at least 50%.

Dawn Machinery Co., Ltd (Taiwan) ”



XK10 system specifications

Launch / S unit and M unit		
System performance	Launch unit	S unit and M unit
Beam measurement range	30 m	20 m
Laser output	Class 2	Class 2
Power	1 x R14(C) battery	Lithium-ion (2.4 Wh) internal battery
Operating time	~ 24 hours	~ 5 hours
Spirit vial resolution	20 µm/m	–
Specified accuracy range	10 °C to 40 °C	10 °C to 40 °C
Recommended recalibration period	2 years	2 years

Display unit	
Power	Internal battery: Lithium-ion (43 Wh) Additional battery: 4 x R14(C)
Operating time	~ 30 hours (internal battery only)
Screen size	5.7"
Wireless range	30 m

Performance specifications

Straightness (Launch & M unit)	
	
Range	±5 mm
Accuracy	±0.01A ±1 µm

A = displayed straightness reading (µm)

Spindle direction	
	
Range	±5 mm
Accuracy (vertical)	±3 µm/300 mm

Squareness	
	
Range	±5 mm
Accuracy*	±0.01A/M ±2/M ±10 µm/m
Accuracy**	±0.01A/M ±2/M ±4 µm/m

A = straightness reading of the furthest point (µm)

M = length of the (shortest) axis (m)

* without squareness calibration factor

** with squareness calibration factor

Parallelism	
	
Range	±5 mm
Accuracy (i)	±0.01A/M ±2/M ±4 µm/m*
Accuracy (ii)	±0.01A ±2 ±4M µm*

* laser to pentaprism distance >0.3 m

(i) angle between rails

(ii) geometric tolerancing relative to the reference rail / point to point variation

A = (largest) straightness reading (µm)

M = length of the axis (m)

Flatness	
	
Range	±5 mm
Accuracy	±0.01A ±1 ±(1 + 1.1M) µm

A = displayed straightness reading (µm)

M = distance to the furthest point (m)

Coaxiality	
	
Range	±5 mm
Accuracy (angle)	±1 µm/100 mm
Accuracy (offset)	±1 µm

Renishaw's machine measurement solutions

Renishaw offers a range of calibration solutions for improved machine performance, increased machine up-time and preventative maintenance schedules.

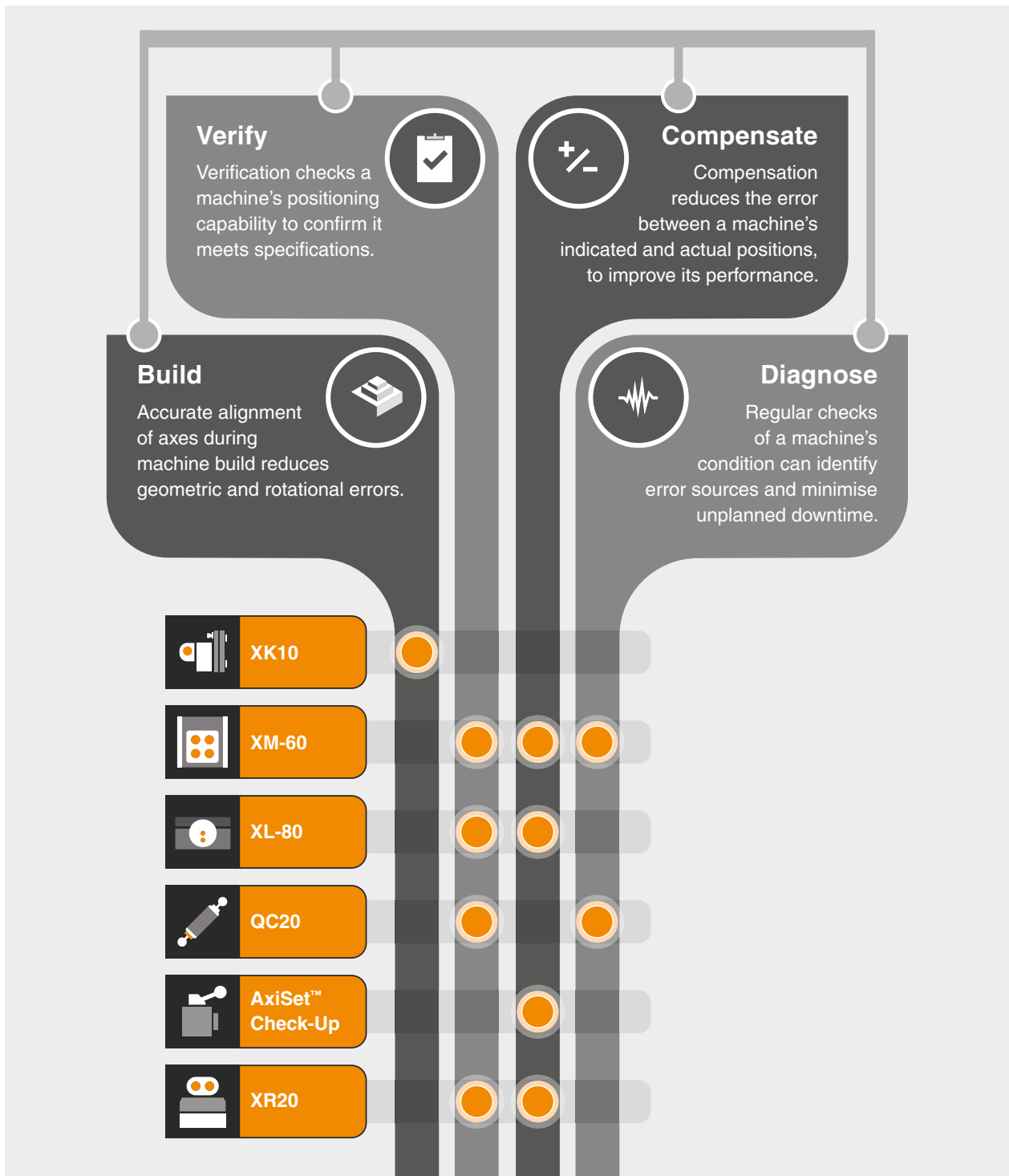

Renishaw's innovation has transformed industrial metrology

Renishaw offers a range of calibration solutions for machine tools, CMMs and other applications:



XL-80 laser measurement system

- The ultimate in traceable, versatile motion system analysis
- ± 0.5 ppm certified linear measurement accuracy



XR20 rotary axis calibrator

- Measurement accuracy of up to ± 1 arc second
- Totally wireless operation for quick and easy set up



XM multi-axis calibrator system

- Measure six degrees of freedom in any orientation from a single set-up
- Unique technology, optical roll measurement and fibre optic launch



QC20 ballbar

- The most widely used system for machine tool performance verification
- Reduces machine down-time, scrap and inspection costs



AxiSet™ Check-Up for machine tools

- Rapid on-machine measurement of rotary axis performance
- Accurate detection and reporting of errors in rotary axis pivot points

Service and quality

Our ongoing commitment to service and quality provides our customers with the complete solution



Training

Renishaw offers an established range of comprehensive operator training courses either on-site or at a Renishaw training centre.

Our experience in metrology allows us to teach not just about our products, but also underlying scientific principles and methods of best practice. This enables our customers to get the most out of their manufacturing processes.

Support

Our products enhance quality and productivity, and we strive for total customer satisfaction through superior customer service and expert knowledge of potential product applications.

When you purchase a laser or ballbar system from Renishaw, you are buying into a worldwide support network that understands machine metrology and the service of production equipment.

Certification

Renishaw plc is certified and audited regularly to the latest ISO 9001 quality assurance standard. This ensures all aspects of design, manufacture, sales, after sales support, and recalibration remain at the highest standards.

The certificate is issued by BSI Management Systems, an internationally recognised certification body, accredited by UKAS.

bsi.

www.renishaw.com/xk10



#renishaw

+44 (0) 1453 524524

 uk@renishaw.com

© 2022 Renishaw plc. All rights reserved. RENISHAW® and the probe symbol are registered trade marks of Renishaw plc. Renishaw product names, designations and the mark 'apply innovation' are trade marks of Renishaw plc or its subsidiaries. Other brand, product or company names are trade marks of their respective owners. Renishaw plc. Registered in England and Wales. Company no: 1106260. Registered office: New Mills, Wotton-under-Edge, Glos, GL12 8JR, UK.

WHILE CONSIDERABLE EFFORT WAS MADE TO VERIFY THE ACCURACY OF THIS DOCUMENT AT PUBLICATION, ALL WARRANTIES, CONDITIONS, REPRESENTATIONS AND LIABILITY, HOWSOEVER ARISING, ARE EXCLUDED TO THE EXTENT PERMITTED BY LAW.

Part no.: L-9936-0756-05-C