

# TONiC™ encoder system

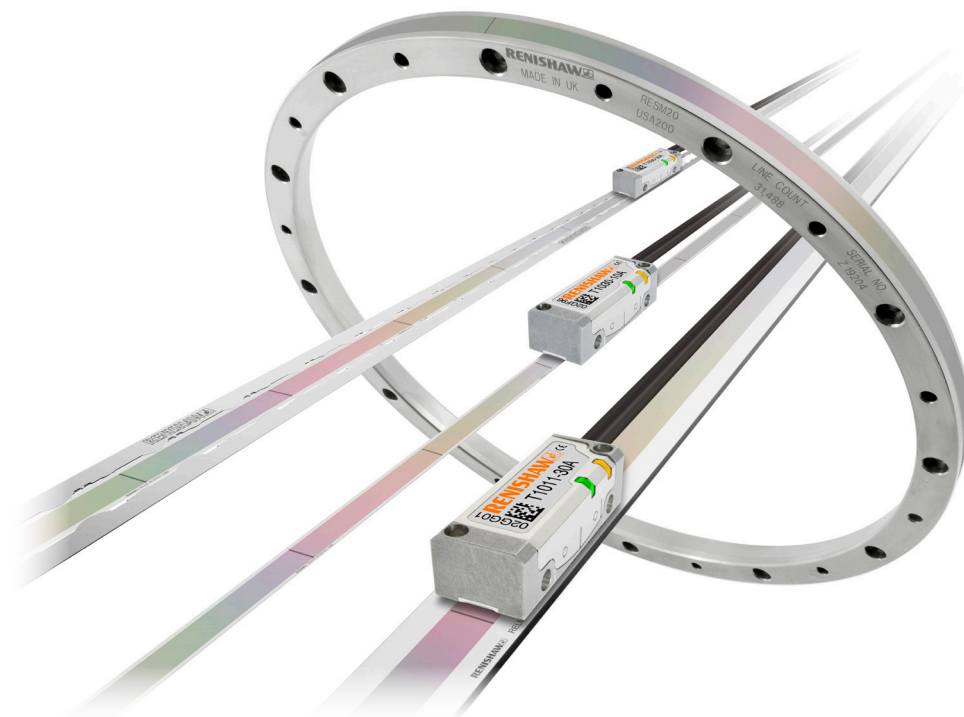

Renishaw's TONiC encoder series is designed for highly-dynamic precision motion systems, bringing higher accuracy, speed and greater reliability to a wide variety of demanding industry sectors.

The readhead is compatible with a wide range of linear, partial arc and rotary scales with bi-directional optical *IN-TRAC*™ reference marks.



For ultimate reliability and high dirt immunity, TONiC encoder system readheads incorporate Renishaw's market-proven filtering optics, tuned for even lower noise (jitter), further enhanced by dynamic signal processing including Auto Gain Control (AGC) and Auto Offset Control (AOC). The result is ultra-low sub-divisional error (SDE), giving smoother velocity control for improved scanning performance and increased positional stability.

TONiC encoder system readheads also feature a detachable analogue or digital interface in the form of a robust, convenient connector that can be located up to 10 m from the readhead. The interface offers digital interpolation to 1 nm resolution, with clocked outputs for optimised speed performance at all resolutions for industry-standard controllers.

- Compact readhead (35 mm × 13.5 mm × 10 mm)
- Compatible with a wide range of linear, partial arc and rotary scales with customer-selectable *IN-TRAC* auto-phase optical reference mark (datum)
- Optimised filtering optics for even lower noise (jitter)
- Dynamic signal processing provides ultra-low SDE of typically ±30 nm
- AGC ensures consistent signal strength for long-term reliability
- Integrated set-up LED for ease of installation
- Maximum speed to 10 m/s (3.24 m/s at 0.1 µm resolution)
- Detachable analogue or digital connector with integral interpolation to 1 nm resolution (0.00075 arc seconds)
- Integral dual limits (linear only)
- Operating temperature to 70 °C
- Dual-resolution version available

## Compatible scales

### Linear scales

	<b>RTL20-S</b> Self-adhesive mounted stainless-steel tape scale	<b>RTL20/FASTRACK™</b> Stainless-steel tape scale and self-adhesive mounted carrier	<b>RKLC20-S<sup>2</sup></b> Self-adhesive mounted stainless-steel tape scale
			
<b>Form (height x width)</b>	0.4 mm x 8 mm including adhesive	RTL20 scale: 0.2 mm x 8 mm FASTRACK carrier: 0.4 mm x 18 mm including adhesive	0.15 mm x 6 mm including adhesive
<b>Accuracy (includes slope and linearity)</b>	±5 µm/m	±5 µm/m	±5 µm/m
<b>Linearity (figures achievable with two-point error correction)</b>	±2.5 µm/m	±2.5 µm/m	±2.5 µm/m
<b>Maximum length</b>	10 m <sup>1</sup> (> 10 m available on request)	10 m (> 10 m available on request)	20 m (> 20 m available on request)
<b>Coefficient of thermal expansion (at 20 °C)</b>	10.1 ±0.2 µm/m/°C	10.1 ±0.2 µm/m/°C	Matches that of substrate material when scale ends fixed by epoxy-mounted end clamps

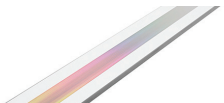
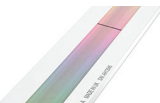

	<b>RSLM20</b> Self-adhesive or clip/clamp mounted stainless-steel spar scale	<b>RELM20</b> Self-adhesive or clip/clamp mounted low-expansion ZeroMet™ spar scale
		
<b>Form (height x width)</b>	1.5 mm x 14.9 mm	1.6 mm x 14.9 mm
<b>Accuracy (includes slope and linearity)</b>	±4 µm (total accuracy over a complete 5 m length)	±1 µm (total accuracy up to 1 m)
<b>Linearity (figures achievable with two-point error correction)</b>	N/A	N/A
<b>Maximum length</b>	5 m	1.5 m
<b>Coefficient of thermal expansion (at 20 °C)</b>	10.1 ±0.2 µm/m/°C	0.75 ±0.35 µm/m/°C

**NOTE:** For more information about the scales refer to the relevant scale data sheet which can be downloaded from [www.renishaw.com/tonicdownloads](http://www.renishaw.com/tonicdownloads).

<sup>1</sup> For RTL20-S axis lengths > 2 m, FASTRACK with RTL20 is recommended.

<sup>2</sup> Suitable for partial arc applications. For more information refer to *RKL scale for partial arc applications* data sheet (Renishaw part no. L-9517-9897).

## Rotary scales

	RESM20	REXM20
	Stainless-steel ring	Ultra-high accuracy stainless-steel ring
		
<b>Accuracy</b>	±1.9 arc second (typical installed accuracy for a 550 mm diameter RESM20 ring) <sup>1</sup>	±1 arc second <sup>2</sup> (total installed accuracy for a 417 mm diameter REXM20 ring)
<b>Ring diameters</b>	52 mm to 550 mm	52 mm to 417 mm
<b>Coefficient of thermal expansion (at 20 °C)</b>	15.5 ±0.5 µm/m/°C	15.5 ±0.5 µm/m/°C

<sup>1</sup> “Typical” installations are a result of graduation and installation errors combining and, to some magnitude, cancelling.

<sup>2</sup> When using two readheads and an additional DSi interface.

# TONiC readhead installation drawing (on RTLC20-S scale)



Dimensions and tolerances in mm

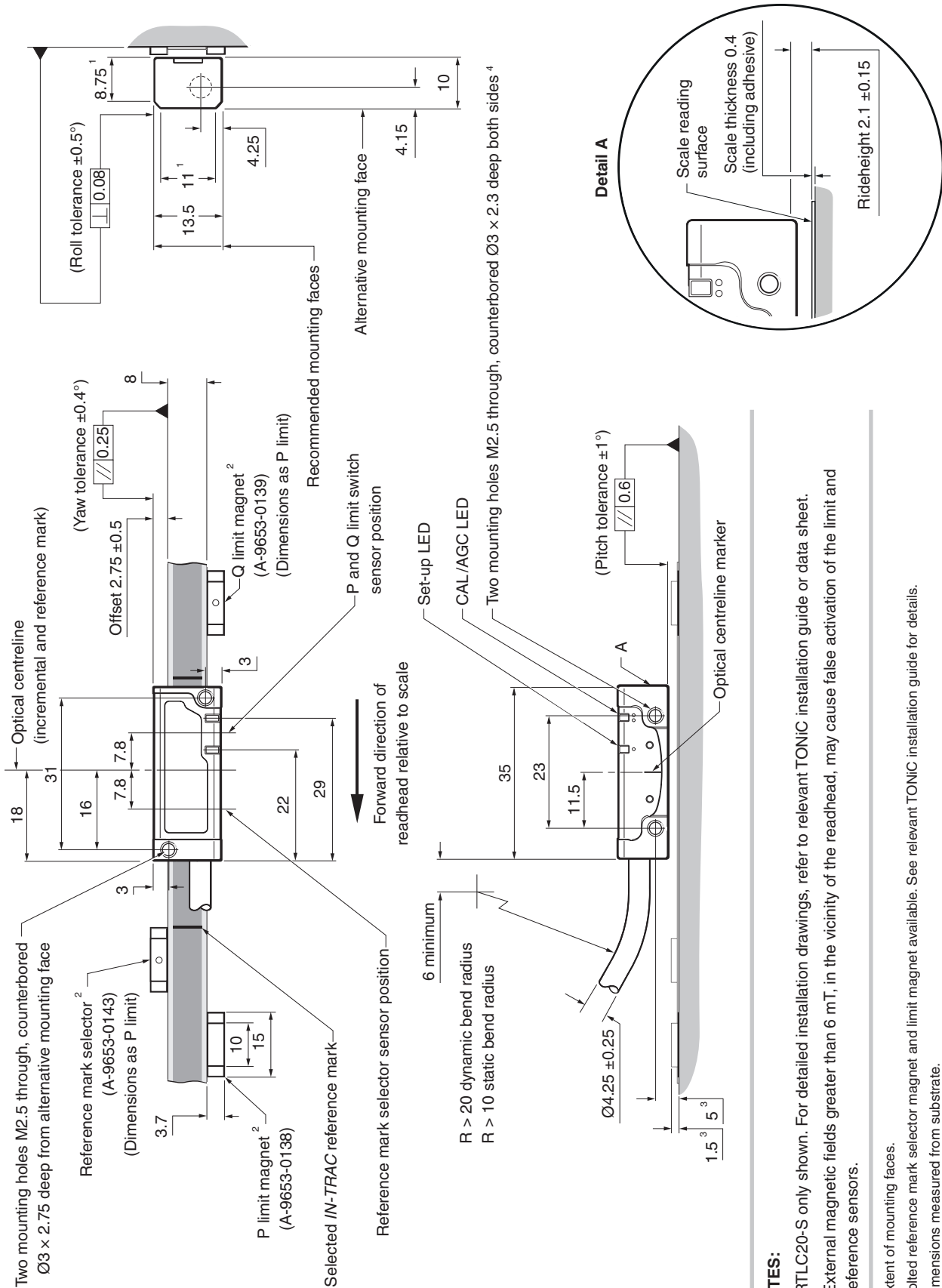

**NOTES:**

- RTLC20-S only shown. For detailed installation drawings, refer to relevant TONiC installation guide or data sheet.
- External magnetic fields greater than 6 mT, in the vicinity of the readhead, may cause false activation of the limit and reference sensors.

<sup>1</sup> Extent of mounting faces.

<sup>2</sup> Bolted reference mark selector magnet and limit magnet available. See relevant TONiC installation guide for details.

<sup>3</sup> Dimensions measured from substrate.

<sup>4</sup> The recommended thread engagement is 5 min (7.5 including counterbore). The recommended tightening torque is between 0.25 and 0.4 Nm.

# TONiC readhead installation drawing (on RESM20 ring)



Dimensions and tolerances in mm

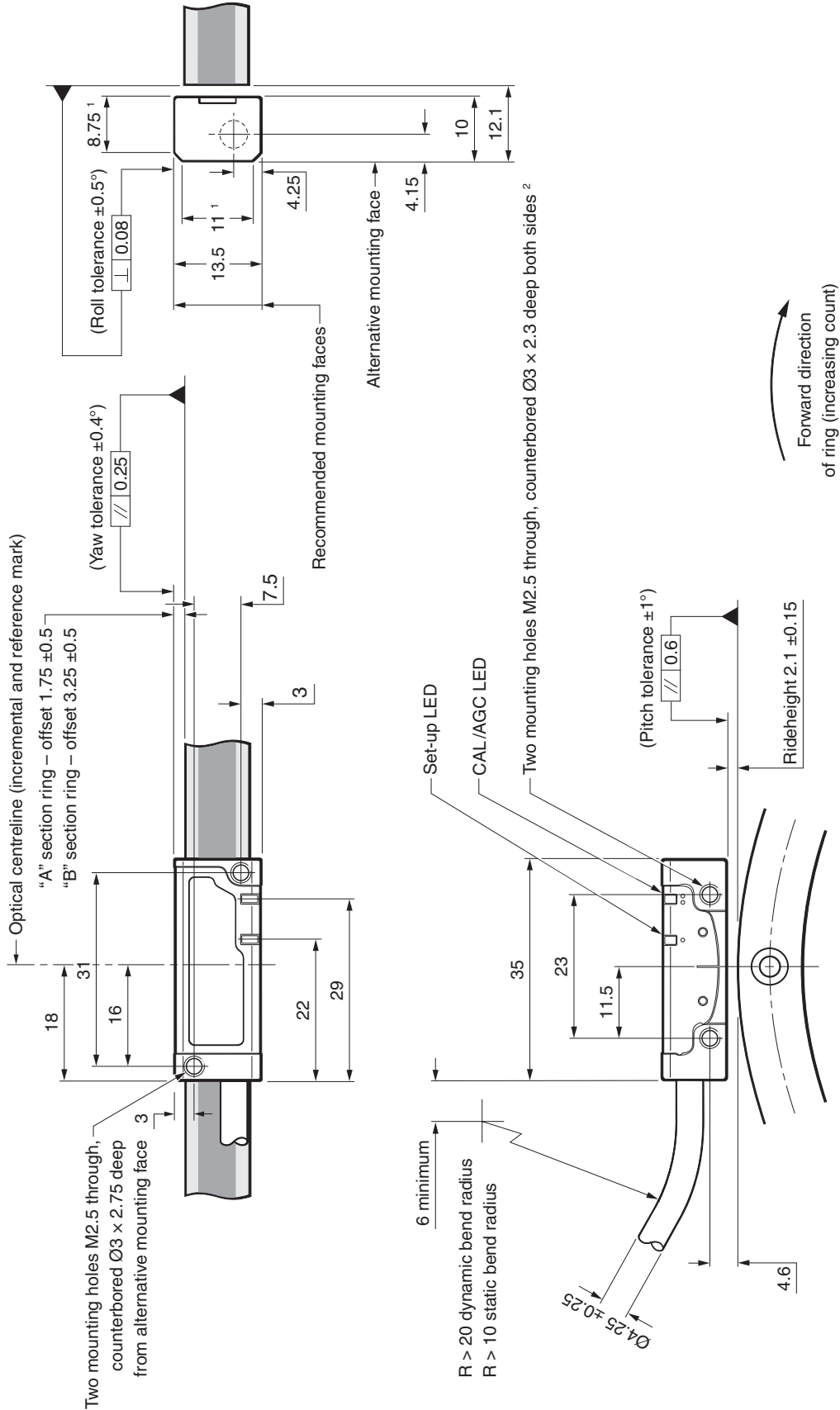

**NOTE:** External magnetic fields greater than 6 mT, in the vicinity of the readhead, may cause false activation of the limit sensor.

<sup>1</sup> Extent of mounting faces.

<sup>2</sup> The recommended thread engagement is 5 min (7.5 including counterbore). The recommended tightening torque is between 0.25 and 0.4 Nm.

## Ti/TD interface dimension drawing



Dimensions and tolerances in mm

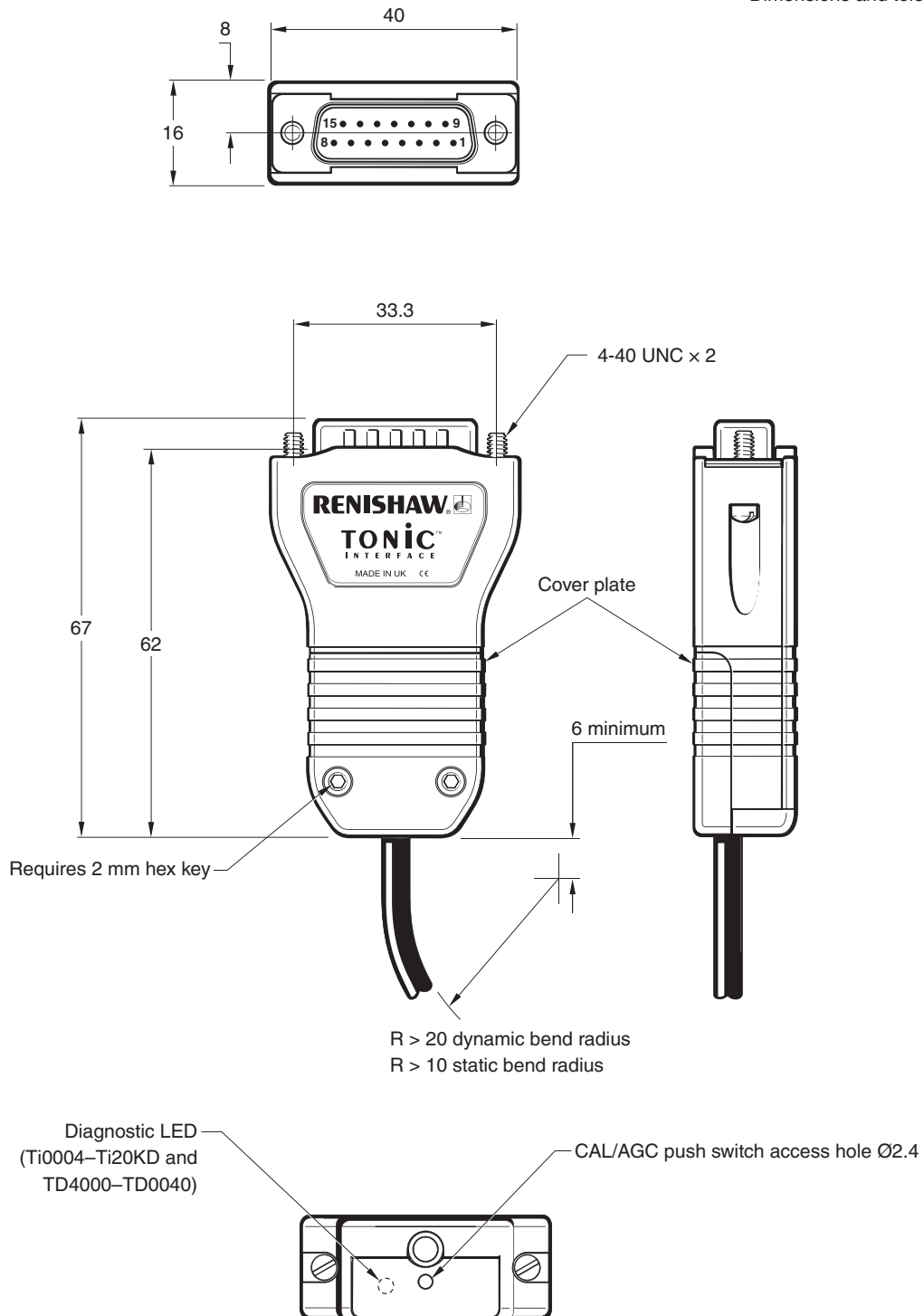

## TD dual resolution interface

Allows output to be switched between two resolutions. See TD interface part number section for details of available resolutions.

### NOTES:

- It is recommended that movement should be halted before switching resolutions.
- There are no limit outputs.

## General specifications

<b>Power supply</b> <sup>1</sup>	5V ±10%	Readhead only < 100 mA T1xxx/T2xxx with Ti0000 < 100 mA T1xxx/T2xxx with Ti0004 - Ti20KD or TD4000 - TD0040 < 200 mA For digital outputs, a further 25 mA per channel pair (e.g., A+, A-) will be drawn when terminated with 120R For analogue outputs, a further 20 mA in total will be drawn when terminated with 120R Power from a 5 Vdc supply complying with the requirements for SELV of standard IEC 60950-1
	Ripple	200 mVpp maximum @ frequency up to 500 kHz
<b>Temperature (system)</b>	Storage	-20 °C to +70 °C
	Operating	0 °C to +70 °C
<b>Humidity (system)</b>		95% relative humidity (non-condensing) to IEC 60068-2-78
<b>Sealing</b>	Readhead	IP40
	Interface	IP20
<b>Acceleration (readhead)</b>	Operating	500 m/s <sup>2</sup> , 3 axes
<b>Shock (system)</b>	Operating	500 m/s <sup>2</sup> , 11 ms, ½ sine, 3 axes
<b>Vibration (system)</b>	Operating	Sinusoidal 100 m/s <sup>2</sup> max @ 55 Hz to 2000 Hz, 3 axes
<b>Mass</b>	Readhead	10 g
	Interface	100 g
	Cable	26 g/m
<b>EMC compliance (system)</b>		IEC 61326-1
<b>Readhead cable</b>		Double-shielded, outside diameter 4.25 ±0.25 mm Flex life > 20 × 10 <sup>6</sup> cycles at 20 mm bend radius UL recognised component 
<b>Typical sub-divisional error (SDE)</b>		±30 nm

<sup>1</sup> Current consumption figures refer to unterminated systems.

## Speed

Clocked output option (MHz)	Maximum speed (m/s)										
	Ti0004 5 µm	Ti0020 1 µm	Ti0040 0.5 µm	Ti0100 0.2 µm	Ti0200 0.1 µm	Ti0400 50 nm	Ti1000 20 nm	Ti2000 10 nm	Ti4000 5 nm	Ti10KD 2 nm	Ti20KD 1 nm
50	10	10	10	6.48	3.240	1.625	0.648	0.324	0.162	0.065	0.032
40	10	10	10	5.40	2.700	1.350	0.540	0.270	0.135	0.054	0.027
25	10	10	8.10	3.24	1.620	0.810	0.324	0.162	0.081	0.032	0.016
20	10	10	6.75	2.70	1.350	0.670	0.270	0.135	0.068	0.027	0.013
12	10	9	4.50	1.80	0.900	0.450	0.180	0.090	0.045	0.018	0.009
10	10	8.10	4.05	1.62	0.810	0.400	0.162	0.081	0.041	0.016	0.0081
08	10	6.48	3.24	1.29	0.648	0.324	0.130	0.065	0.032	0.013	0.0065
06	10	4.50	2.25	0.90	0.450	0.225	0.090	0.045	0.023	0.009	0.0045
04	10	3.37	1.68	0.67	0.338	0.169	0.068	0.034	0.017	0.0068	0.0034
01	4.2	0.84	0.42	0.16	0.084	0.042	0.017	0.008	0.004	0.0017	0.0008
Analogue output	10 (-3 dB)										

**NOTE:** TD interface maximum speeds are resolution dependent, as defined above.

Angular speed depends on ring diameter – use the following equation to convert to rev/min:

$$\text{Angular speed (rev/min)} = \frac{V \times 1000 \times 60}{\pi D} \quad \text{Where } V = \text{maximum linear speed (m/s) and} \\ D = \text{external diameter of RESM20 or REXM20 ring (mm).}$$



## Output signals

### Digital outputs

Function	Signal	Interface		
		Ti0004 – Ti20KD	TD4000 –TD0040	
Power	5 V	7, 8	7, 8	
	0 V	2, 9	2, 9	
Incremental	A	+	14	14
		–	6	6
	B	+	13	13
		–	5	5
Reference mark	Z	+	12	12
		–	4	4
Limits	P <sup>1</sup>	11	-	
	Q <sup>3</sup>	10	-	
Set-up	X	1	1	
Alarm <sup>2</sup>	E	+	-	11
		–	3	3
Resolution switching <sup>3</sup>	-	-	10	
Shield	Inner	-	-	
	Outer	Case	Case	

### Analogue outputs

Function	Signal	Readhead T1xxx/2xxx	Interface Ti0000		
		Colour	Pin		
Power	5 V	Brown	4, 5		
	0 V	White	12, 13		
Incremental	Cosine	V <sub>1</sub>	+	Red	9
			–	Blue	1
	Sine	V <sub>2</sub>	+	Yellow	10
			–	Green	2
Reference mark	V <sub>0</sub>	+	Violet	3	
		–	Grey	11	
Limits	V <sub>p</sub>	Pink	7		
	V <sub>q</sub>	Black	8		
Set-up	V <sub>x</sub>	Clear	6		
Remote CAL	CAL	Orange	14		
Shield	Inner	Green/Yellow <sup>4</sup>	-		
	Outer	Outer screen	Case		



15-pin D-type connector

<sup>1</sup> Becomes alarm (E+) for Ti options E, F, G, H.

<sup>2</sup> The alarm signal can be output as a line-driven signal or 3-state. Please select the preferred option at time of ordering.

<sup>3</sup> On TD interfaces pin 10 should be connected to 0 V to switch to lower resolution.

<sup>4</sup> Inner shield is connected to 0 V inside the Ti / TD interface.

## Electrical connections

### Grounding and shielding

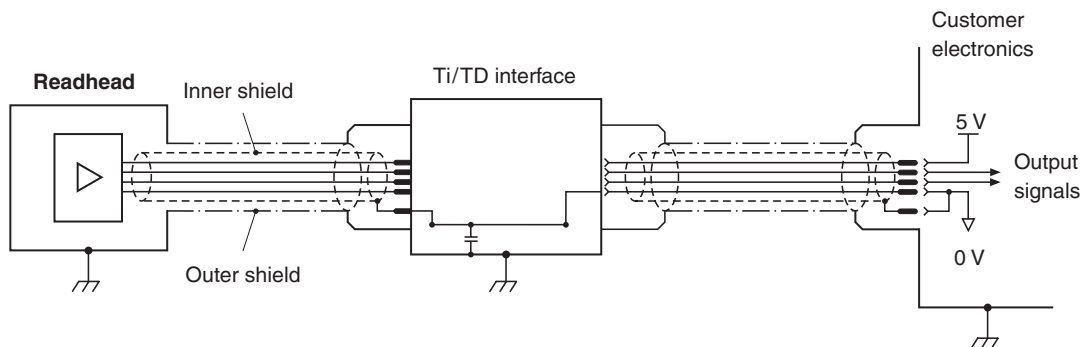

**IMPORTANT:** The outer shield should be connected to the machine earth (field ground). The inner shield should be connected to 0 V at receiving electronics only. Care should be taken to ensure that the inner and outer shields are insulated from each other. If the inner and outer shields are connected together, this will cause a short between 0 V and earth, which could cause electrical noise issues.

### Maximum cable length

Readhead to interface: 10 m  
Interface to controller: Dependent on clocked output option.  
See table below for details.

Receiver clock frequency (MHz)	Maximum cable length (m)
40 to 50	25
< 40	50
analogue	50

### Remote CAL operation (analogue versions only)

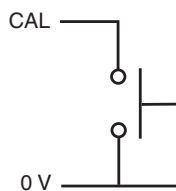

All Ti and TD interfaces include a push-button switch to enable CAL/AGC features.

Remote operation of the CAL/AGC is possible via pin 14 of analogue Ti0000 interfaces.

For applications where no interface is used, remote operation of CAL/AGC is essential.

## Recommended signal termination

### Digital outputs

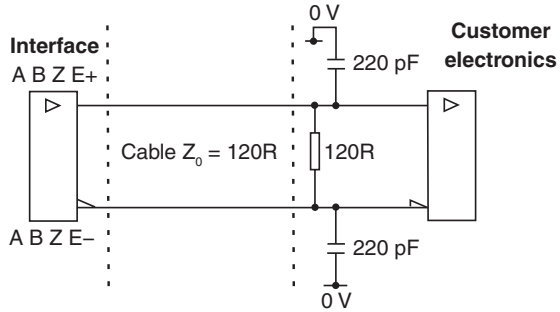

Standard RS422A line receiver circuitry.

Capacitors recommended for improved noise immunity.

### Single-ended alarm signal termination (Ti options A, B, C, D)

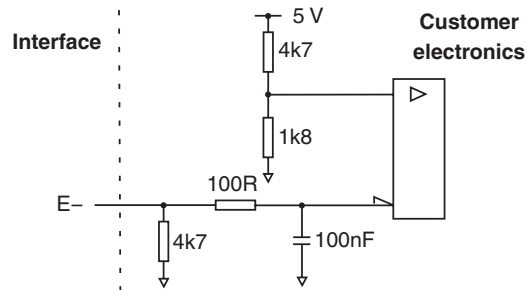

### Limit outputs (Ti interface only)

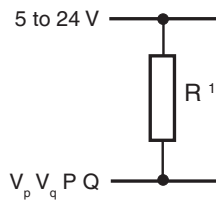

### Analogue outputs

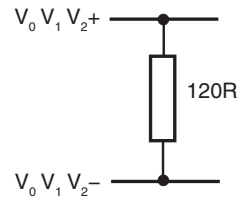

<sup>1</sup> Select R so maximum current does not exceed 20 mA. Alternatively, use a suitable relay or opto-isolator.

# Output specifications

## Digital output signals

### Interface models Ti0004 – Ti20KD and TD4000 – TD0040

Form – Square wave differential line driver to EIA RS422A (except limits P and Q).

#### Incremental <sup>1</sup>

Two channels A and B in quadrature (90° phase shifted)

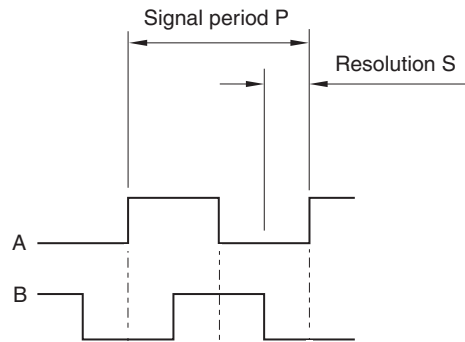

Model	P (μm)	S (μm)
Ti0004	20	5
Ti0020	4	1
Ti0040	2	0.5
Ti0100	0.8	0.2
Ti0200	0.4	0.1
Ti0400	0.2	0.05
Ti1000	0.08	0.02
Ti2000	0.04	0.01
Ti4000	0.02	0.005
Ti10KD	0.008	0.002
Ti20KD	0.004	0.001

#### Reference <sup>1</sup>

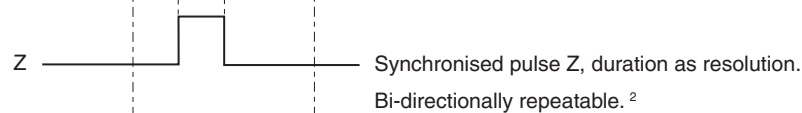

#### Wide reference <sup>1</sup>

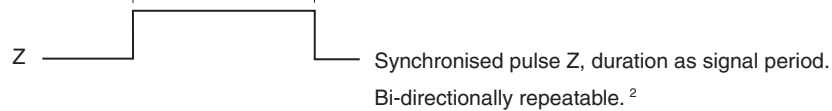

#### NOTES:

- Select “standard” or “wide” reference at time of ordering, to match the requirements of the controller being used.
- Wide reference mark not available on Ti0004.

<sup>1</sup> For clarity, the inverse signals are not shown.

<sup>2</sup> Only the calibrated reference mark is bi-directionally repeatable.

## Limits

Open collector output, asynchronous pulse.

### Digital Ti interfaces only

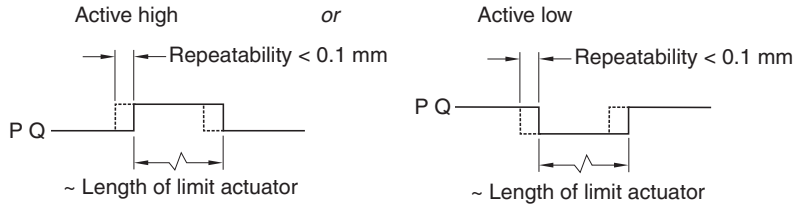

#### NOTES:

- There are no limits on TD interfaces.
- P limit becomes E+ for Ti options E, F, G and H.

## Alarm <sup>1</sup>

Line driven (asynchronous pulse)

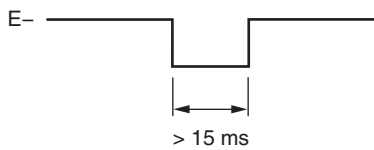

Alarm asserted when:

- Signal amplitude < 20% or > 135%
- Readhead speed too high for reliable operation

Inverse signal E+ only available for Ti options E, F, G and H.

or 3-state alarm

Differentially transmitted signals are forced open circuit for > 15 ms when the alarm conditions are valid.

## Set-up <sup>2</sup>

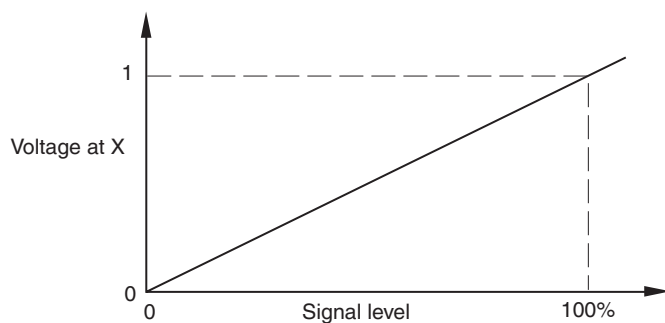

The set-up signal voltage is proportional to incremental signal amplitude.

<sup>1</sup> For clarity, the inverse signals are not shown.

<sup>2</sup> The set-up signal as shown is not present during the calibration routine.

## Analogue output signals

### Interface model Ti0000 and direct output from all readheads

#### Incremental

Two channels  $V_1$  and  $V_2$  differential sinusoids in quadrature, centred on 1.65 V (90° phase shifted).

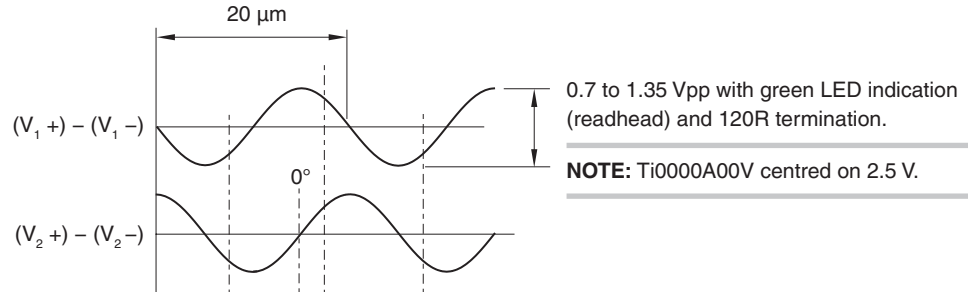

#### Reference

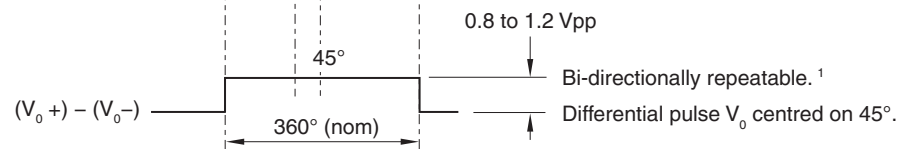

#### Limits

Open collector output, asynchronous pulse.

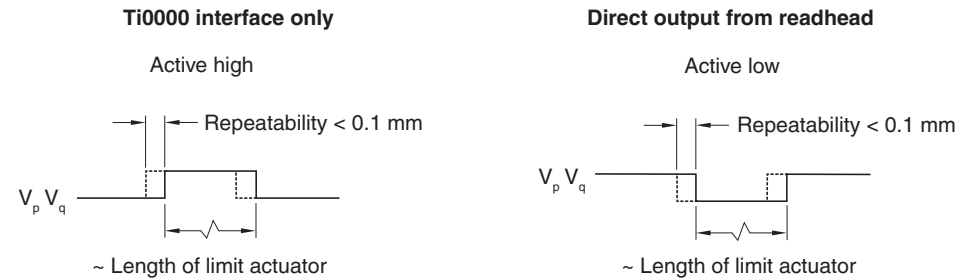

**NOTE:** Ti0000 interface contains a transistor to invert the readhead's "active low" signal to give an "active high" output.

#### Set-up <sup>2</sup>

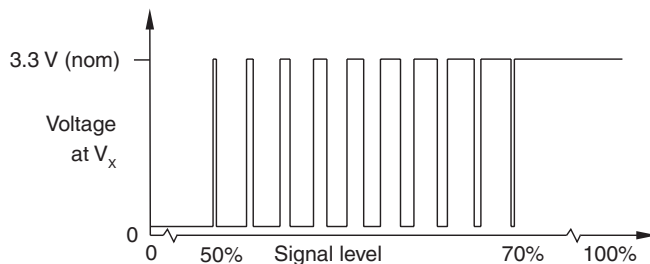

Between 50% and 70% signal level,  $V_x$  is a duty cycle.

Time spent at 3.3 V increases with incremental signal level.

At > 70% signal level  $V_x$  is nominal 3.3 V.

<sup>1</sup> Only the calibrated reference mark is bi-directionally repeatable.

<sup>2</sup> The set-up signal as shown is not present during calibration routine.

## Linear readhead part numbers

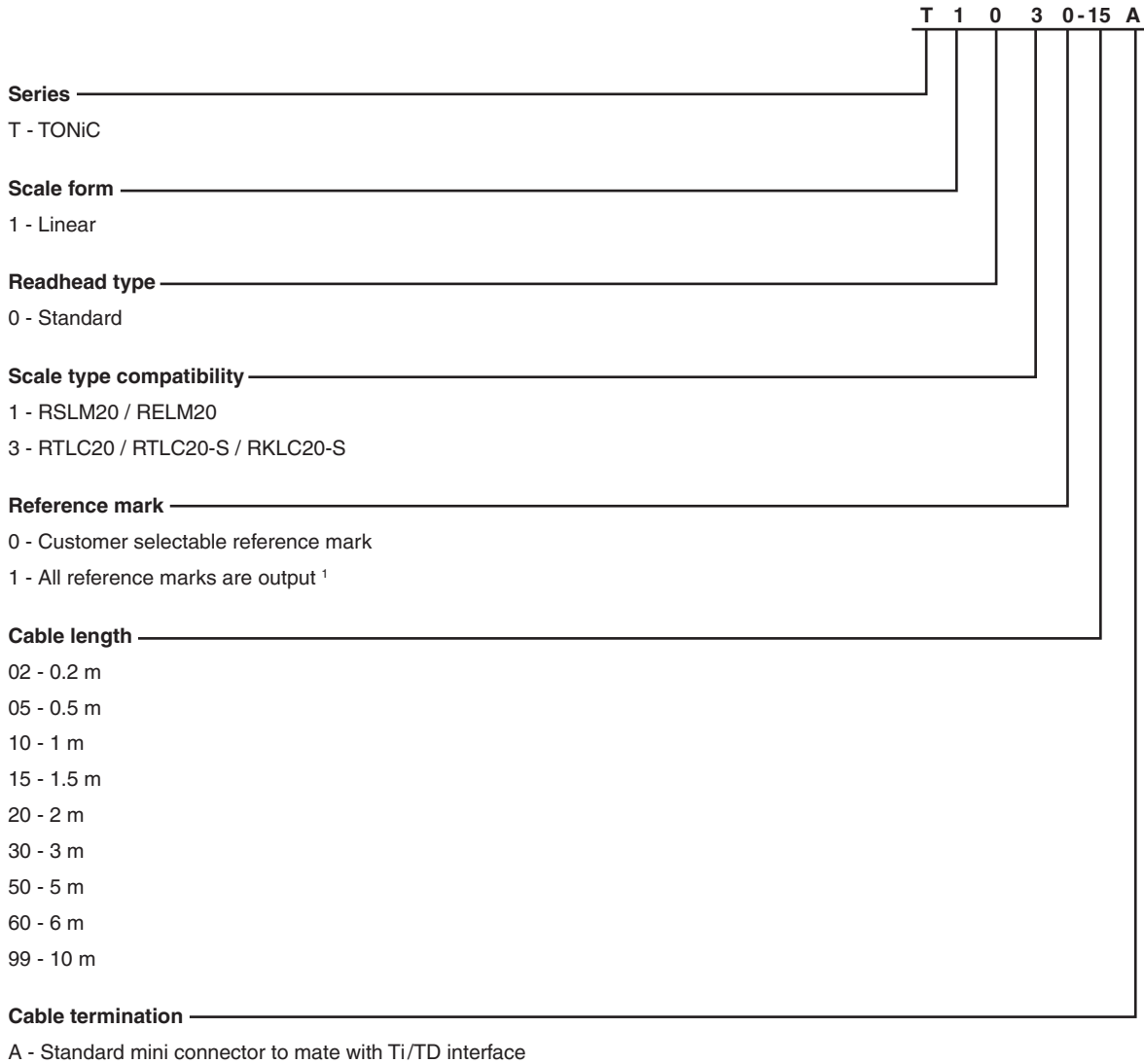

**NOTE:** Not all combinations are valid. Check valid options online at [www.renishaw.com/epc](http://www.renishaw.com/epc).

<sup>1</sup> Only the calibrated reference mark is bi-directionally repeatable.

## Rotary readhead part numbers

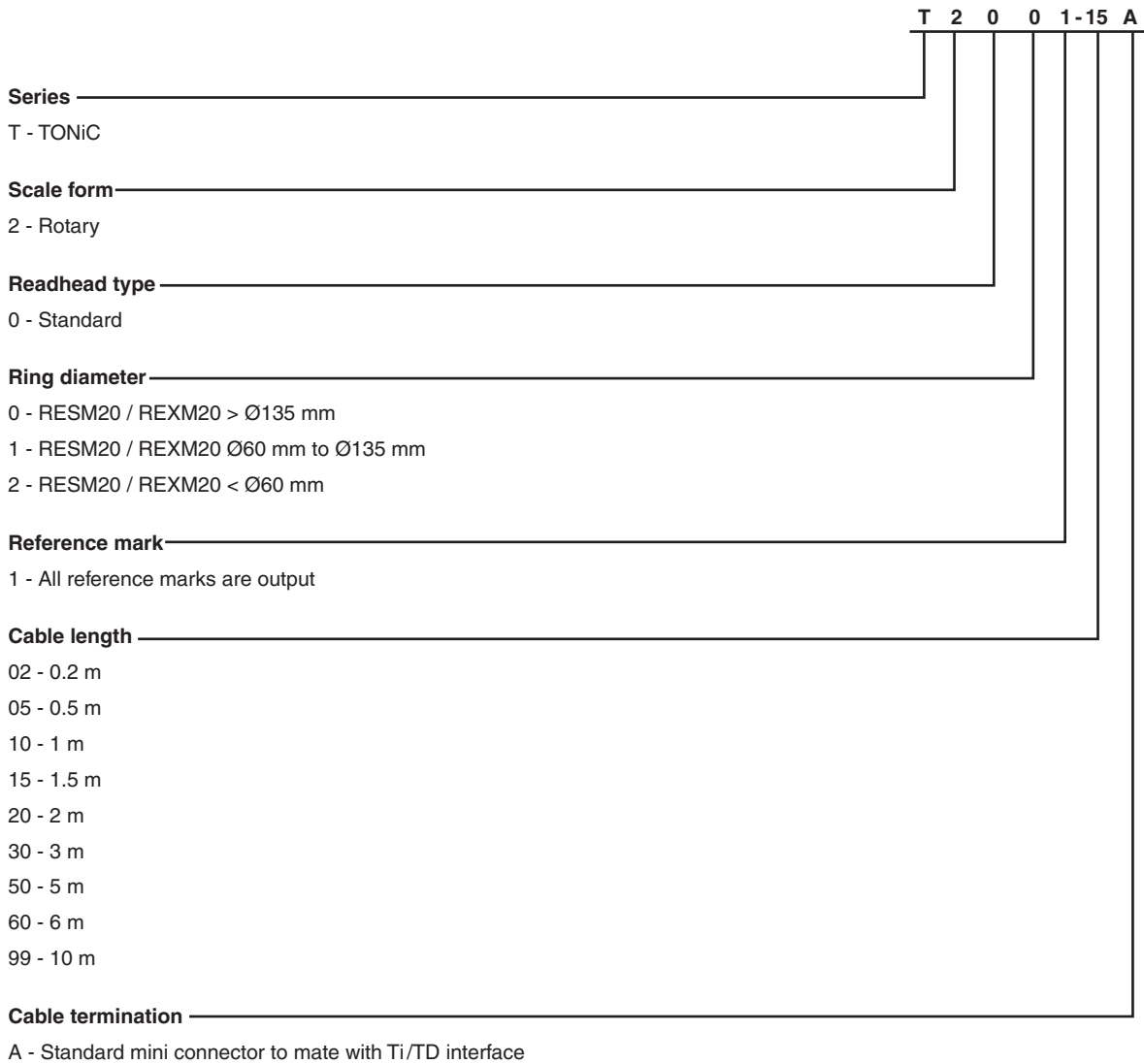

**NOTE:** Not all combinations are valid. Check valid options online at [www.renishaw.com/epc](http://www.renishaw.com/epc).



## Partial arc readhead part numbers

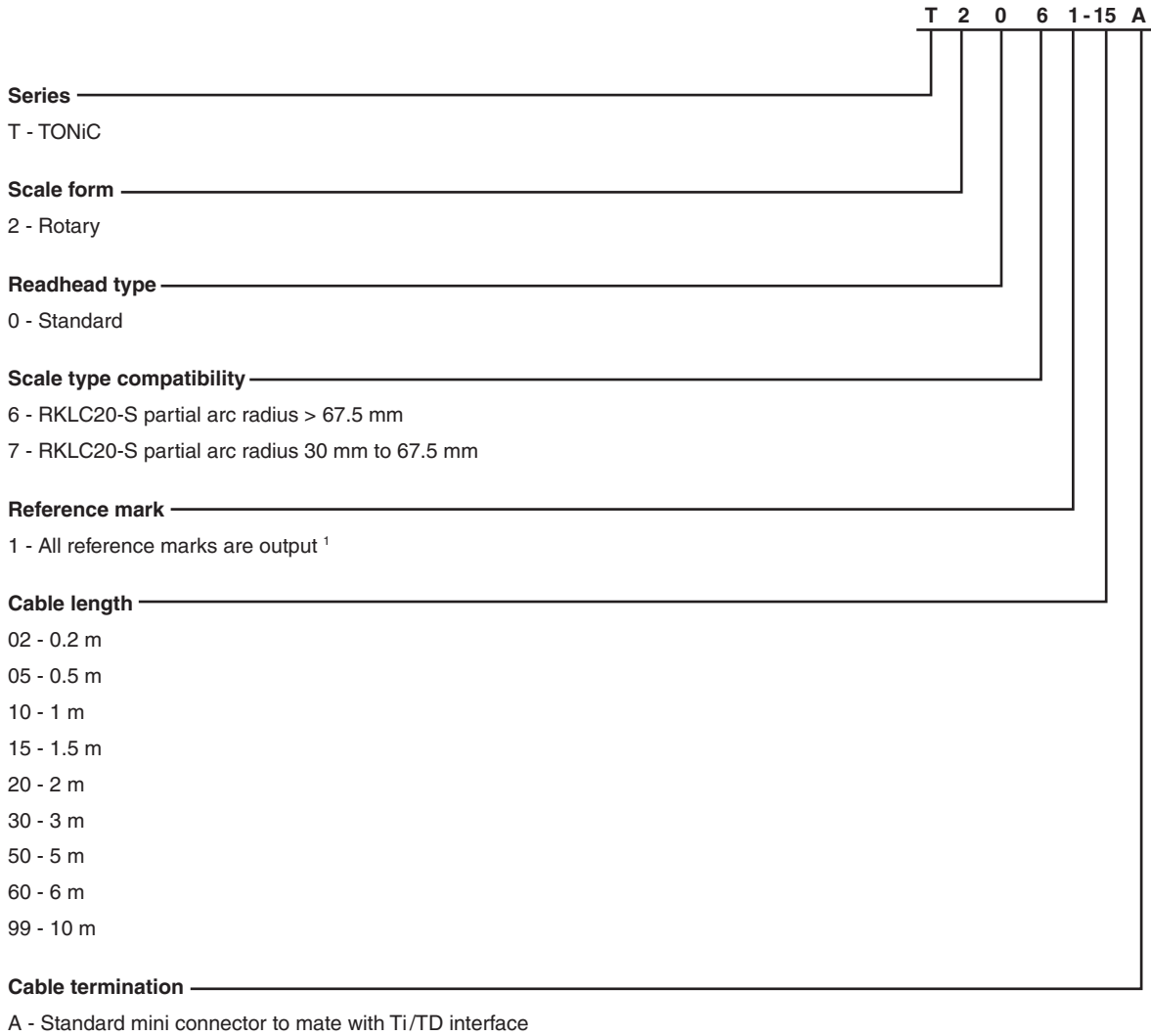

---

### NOTES:

- For more information refer to *RKL scale for partial arc applications* data sheet (Renishaw part no. L-9517-9897).
  - Not all combinations are valid. Check valid options online at [www.renishaw.com/epc](http://www.renishaw.com/epc).
- 

<sup>1</sup> Only the calibrated reference mark is bi-directionally repeatable.

## Ti interface part numbers

Compatible with all TONiC readheads

### Analogue

Ti 0000 A 00 A

#### Options

A - Dual active high limits

V - 2V5 Vmid dual active high limits

### Digital

Ti 0200 A 20 A

#### Series

Ti - TONiC interface

#### Interpolation factor/resolution <sup>1</sup>

0004 - 5 μm <sup>2</sup>	1000 - 20 nm
0020 - 1 μm	2000 - 10 nm
0040 - 0.5 μm	4000 - 5 nm
0100 - 0.2 μm	10KD - 2 nm
0200 - 0.1 μm	20KD - 1 nm
0400 - 50 nm	

#### Alarm format and conditions <sup>3</sup>

A - Line driven E output; All alarms

B - Line driven E output; Low signal and high signal alarms only

E - 3-state; All alarms

F - 3-state; Low signal and high signal alarms only

#### Clocked output option <sup>3</sup>

50 - 50 MHz	10 - 10 MHz
40 - 40 MHz	08 - 8 MHz
25 - 25 MHz	06 - 6 MHz
20 - 20 MHz	04 - 4 MHz
12 - 12 MHz	01 - 1 MHz

#### Options

A - P/Q limits – “active high”, standard reference mark

B - P/Q limits – “active low”, standard reference mark

C - P/Q limits – “active high”, wide reference mark <sup>2</sup>

D - P/Q limits – “active low”, wide reference mark <sup>2</sup>

E - Q limit only – “active high”, differential alarm, standard reference mark

F - Q limit only – “active low”, differential alarm, standard reference mark

G - Q limit only – “active high”, differential alarm, wide reference mark <sup>2</sup>

H - Q limit only – “active low”, differential alarm, wide reference mark <sup>2</sup>

**NOTE:** Not all combinations are valid. Check valid options online at [www.renishaw.com/epc](http://www.renishaw.com/epc).

<sup>1</sup> Additional interpolation factors available. Contact your local Renishaw representative for further details.

<sup>2</sup> Wide reference mark not available on Ti0004 (5 μm) interfaces.

<sup>3</sup> When using with a DSi, the interface should be configured with line-driven alarm outputs and a clocked output option of 01, 04, 06, 08, 10, 12 or 20.

## TD interface part numbers

Compatible with all TONiC readheads

### Dual resolution

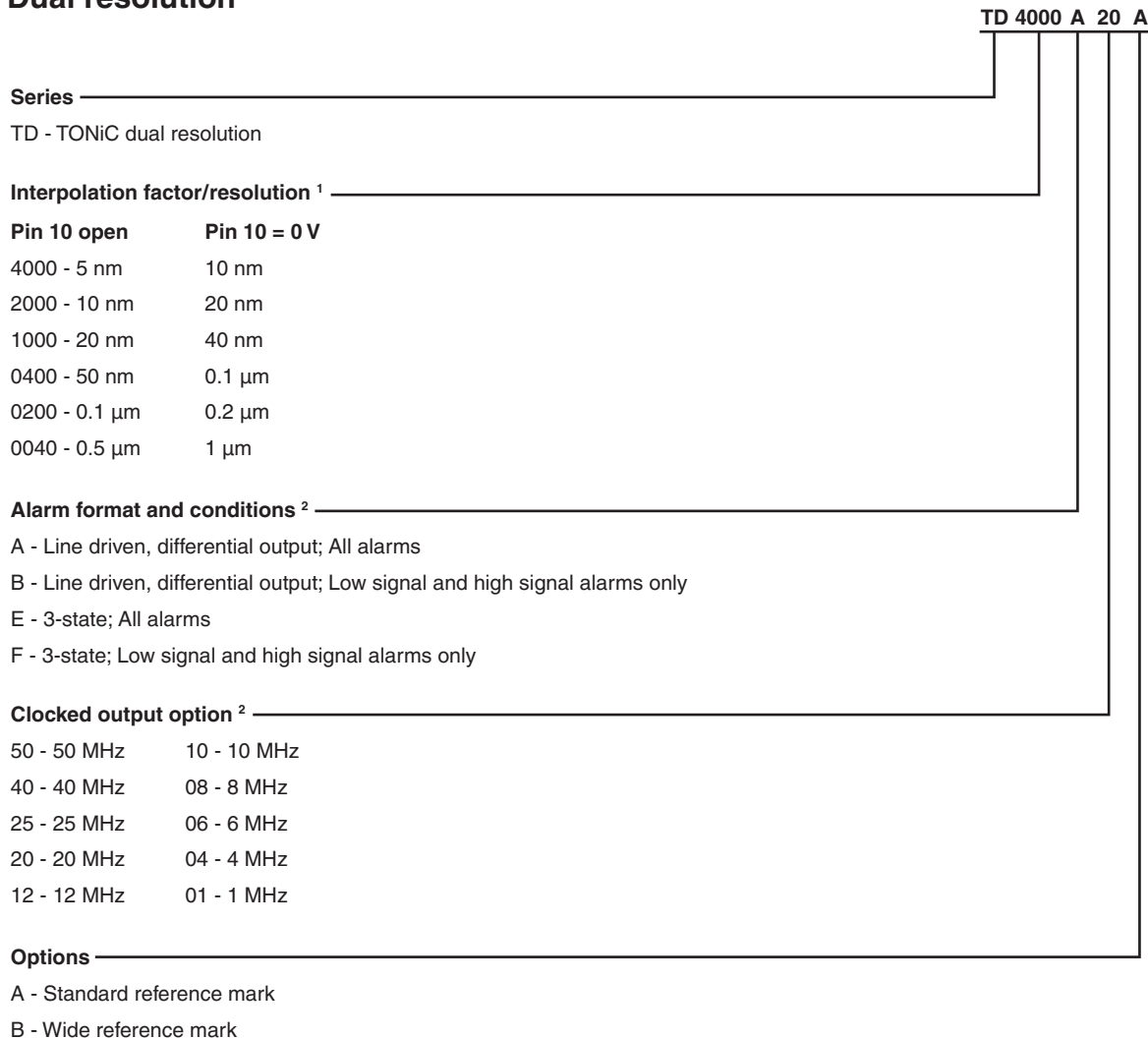

**NOTE:** Not all combinations are valid. Check valid options online at [www.renishaw.com/epc](http://www.renishaw.com/epc).

<sup>1</sup> Additional interpolation factors are available. Contact your local Renishaw representative for further details.

<sup>2</sup> When using with a DSi, the TD interface should be configured with line-driven alarm outputs and a clocked output option of 01, 04, 06, 08, 10, 12 or 20.

## TONiC compatible products

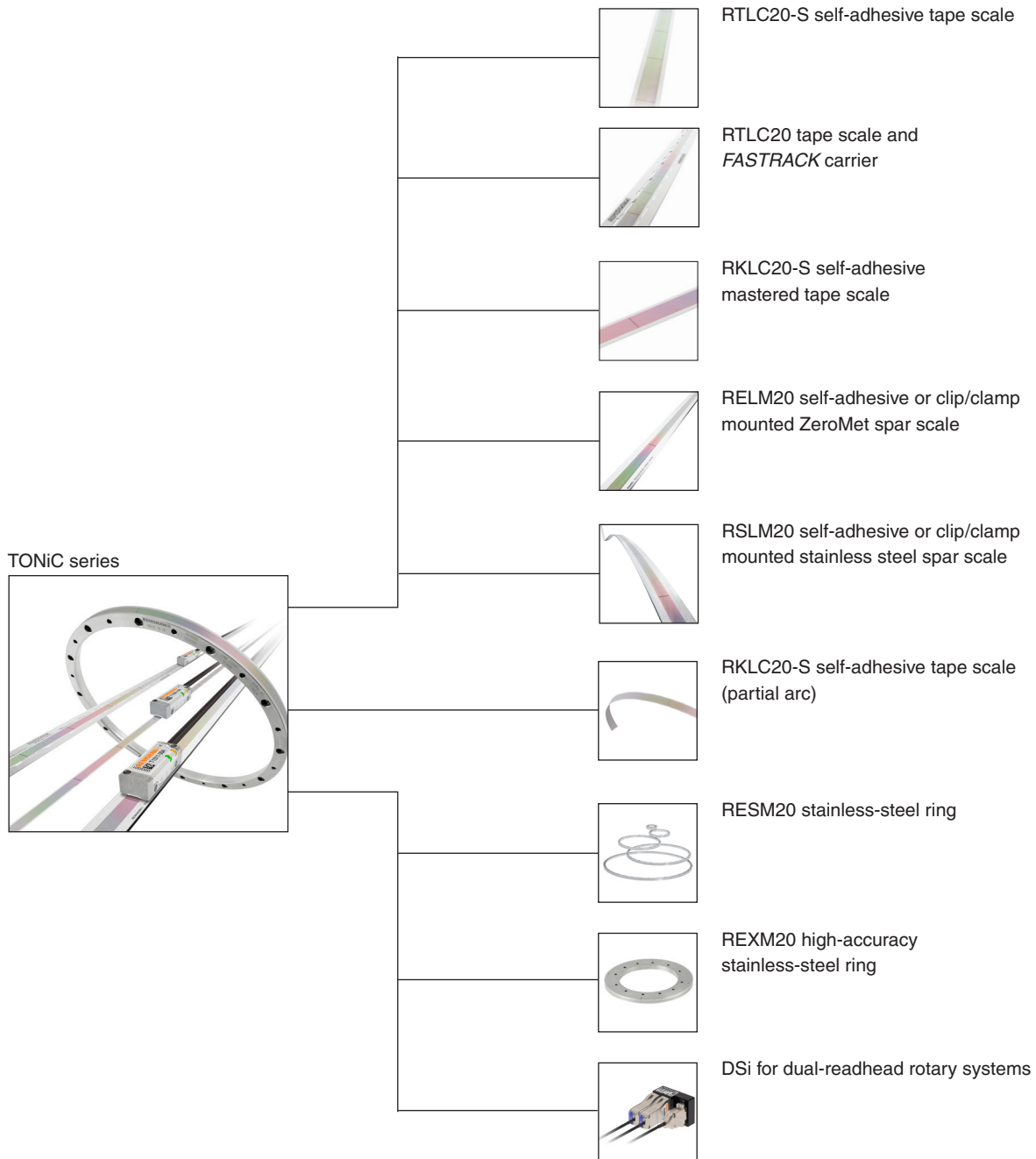

[www.renishaw.com/contact](http://www.renishaw.com/contact)

#renishaw

+44 (0) 1453 524524

uk@renishaw.com

© 2009–2024 Renishaw plc. All rights reserved. This document may not be copied or reproduced in whole or in part, or transferred to any other media or language by any means, without the prior written permission of Renishaw.

RENISHAW® and the probe symbol are registered trade marks of Renishaw plc. Renishaw product names, designations and the mark "apply innovation" are trade marks of Renishaw plc or its subsidiaries. Other brand, product or company names are trade marks of their respective owners.

WHILE CONSIDERABLE EFFORT WAS MADE TO VERIFY THE ACCURACY OF THIS DOCUMENT AT PUBLICATION, ALL WARRANTIES, CONDITIONS, REPRESENTATIONS AND LIABILITY, HOWSOEVER ARISING, ARE EXCLUDED TO THE EXTENT PERMITTED BY LAW. RENISHAW RESERVES THE RIGHT TO MAKE CHANGES TO THIS DOCUMENT AND TO THE EQUIPMENT, AND/OR SOFTWARE AND THE SPECIFICATION DESCRIBED HEREIN WITHOUT OBLIGATION TO PROVIDE NOTICE OF SUCH CHANGES.

Renishaw plc. Registered in England and Wales. Company no: 1106260. Registered office: New Mills, Wotton-under-Edge, Glos, GL12 8JR, UK.

Part no.: L-9517-9337-08-A

Issued: 07.2024